

**FMI 4-93.2**

---

---

**The Sustainment Brigade**

---

---

**February 2009**

**DISTRIBUTION RESTRICTION: Approved for public release; distribution is unlimited.**

---

---

**Headquarters, Department of the Army**

---

---

**This publication is available at  
Army Knowledge Online ([www.us.army.mil](http://www.us.army.mil))  
and the General Dennis J. Reimer  
Training and Doctrine Digital Library at  
([www.train.army.mil](http://www.train.army.mil))**

# THE SUSTAINMENT BRIGADE

## Contents

	Page
<b>PREFACE</b> .....	vi
<b>SECTION I – THEATER OPERATIONAL ENVIRONMENT</b> .....	1-1
THEATER OF OPERATIONS .....	1-2
<b>SECTION II – COMMAND AND SUPPORT RELATIONSHIPS</b> .....	1-2
COMMAND RELATIONSHIPS.....	1-2
SUPPORT RELATIONSHIPS .....	1-4
PRIORITIES OF SUPPORT AND UNITY OF EFFORT.....	1-6
<b>SECTION III – STRATEGIC LEVEL SUPPORT ORGANIZATIONS</b> .....	1-9
US TRANSPORTATION COMMAND (USTRANSCOM).....	1-9
DEFENSE LOGISTICS AGENCY (DLA).....	1-11
US ARMY MATERIEL COMMAND (USAMC) .....	1-11
<b>SECTION IV – SUPPORT OF MILITARY, CIVILIAN, JOINT, AND MULTINATIONAL ORGANIZATIONS</b> .....	1-15
ORGANIZING THE JOINT FORCE .....	1-15
SUSTAINMENT BRIGADE ROLE.....	1-15
INTERAGENCY SUPPORT .....	1-17
HOST NATION SUPPORT .....	1-18
MULTINATIONAL SUPPORT .....	1-18
<b>Chapter 2 MISSIONS AND ORGANIZATION</b> .....	2-1
<b>SECTION I – MISSIONS AND TASKS</b> .....	2-1
GENERAL .....	2-1
MISSIONS .....	2-1
THEATER OPENING MISSION.....	2-4
THEATER DISTRIBUTION MISSION.....	2-7

---

**Distribution Restriction:** Approved for public release; distribution is unlimited.

	SUSTAINMENT MISSION .....	2-9
	ARMY UNIVERSAL TASK LIST (AUTL) TASKS.....	2-12
	<b>SECTION II – STAFF ROLES AND FUNCTIONS .....</b>	<b>2-13</b>
	THE COMMAND GROUP.....	2-13
	SUPPORT OPERATIONS (SPO) SECTION.....	2-15
	SPECIAL AND PERSONAL STAFF .....	2-20
	<b>SECTION III - THE SPECIAL TROOPS BATTALION (STB) .....</b>	<b>2-25</b>
	STB HEADQUARTERS .....	2-25
	<b>SECTION IV - FUNCTIONAL ORGANIZATIONS .....</b>	<b>2-28</b>
	FINANCIAL MANAGEMENT COMPANY (FM CO).....	2-28
	HUMAN RESOURCES (HR) COMPANY, PLATOONS OR TEAMS .....	2-29
	<b>SECTION V – DISTRIBUTION AND MATERIEL MANAGEMENT .....</b>	<b>2-30</b>
	COMMAND AND CONTROL OF DISTRIBUTION .....	2-31
	PHYSICAL DISTRIBUTION.....	2-31
	MATERIEL MANAGEMENT .....	2-32
<b>Chapter 3</b>	<b>COMMAND, CONTROL, AUTOMATION, AND COMMUNICATION.....</b>	<b>3-1</b>
	<b>SECTION I – COMMAND AND CONTROL.....</b>	<b>3-1</b>
	ROLE OF THE COMMANDER.....	3-1
	SUBORDINATE UNITS AND ACTIVITIES.....	3-1
	LIAISON REQUIREMENTS.....	3-1
	STAFF FUNCTIONS.....	3-1
	COMMAND AND CONTROL (C2) SYSTEM.....	3-2
	<b>SECTION II - AUTOMATION .....</b>	<b>3-2</b>
	C2 AUTOMATION SYSTEMS .....	3-2
	STANDARD ARMY MANAGEMENT INFORMATION SYSTEMS .....	3-5
	JOINT SYSTEMS.....	3-10
	TECHNOLOGIES .....	3-11
	EMERGING SYSTEMS .....	3-12
	<b>SECTION III - COMMUNICATIONS.....</b>	<b>3-13</b>
	S-6 STAFF SECTION .....	3-13
	BRIGADE SIGNAL COMPANY .....	3-14
	COMMUNICATIONS SUPPORT PLAN .....	3-15
	HOST NATION INTERFACE .....	3-16
	RADIO NETS .....	3-16
	MOVEMENT TRACKING SYSTEM (MTS).....	3-17
	CONTINGENCY SATELLITE COMMUNICATIONS .....	3-17
<b>Chapter 4</b>	<b>SUPPORT TO THE WARFIGHTER.....</b>	<b>4-1</b>
	<b>SECTION I – OVERVIEW.....</b>	<b>4-1</b>
	SUSTAINMENT WARFIGHTING FUNCTION.....	4-1
	<b>SECTION II – COMBAT SUSTAINMENT SUPPORT BATTALION (CSSB)....</b>	<b>4-3</b>
	<b>SECTION III – LOGISTICS SUBFUNCTION .....</b>	<b>4-5</b>
	MAINTENANCE .....	4-6
	SUPPLY .....	4-7

	FIELD SERVICES .....	4-22
	TRANSPORTATION .....	4-27
	<b>SECTION IV – PERSONNEL SERVICES SUBFUNCTION .....</b>	<b>4-49</b>
	HUMAN RESOURCES SUPPORT .....	4-49
	FINANCIAL MANAGEMENT OPERATIONS .....	4-51
	<b>SECTION V – ARMY HEALTH SERVICE SUPPORT SUBFUNCTION .....</b>	<b>4-52</b>
	ARMY HEALTH SYSTEM (AHS) SUPPORT .....	4-52
<b>Appendix A</b>	<b>LOGISTICS PREPARATION OF THE BATTLEFIELD .....</b>	<b>A-1</b>
	INTELLIGENCE IN SUPPORT OF LOGISTICS .....	A-1
	RELEVANT LOGISTICS INFORMATION .....	A-2
	SOURCES OF INFORMATION .....	A-3
<b>Appendix B</b>	<b>PROTECTION .....</b>	<b>B-1</b>
	<b>SECTION I – RESPONSIBILITIES AND RISK MANAGEMENT .....</b>	<b>B-1</b>
	RESPONSIBILITIES OF THE SUSTAINMENT BRIGADE .....	B-1
	RISK MANAGEMENT .....	B-1
	<b>SECTION II – THE THREAT .....</b>	<b>B-2</b>
	COMBAT ACTION .....	B-3
	<b>SECTION III – CHEMICAL, BIOLOGICAL, RADIOLOGICAL, AND NUCLEAR (CBRN) ENVIRONMENT .....</b>	<b>B-4</b>
	CBRN DEFENSE .....	B-4
	CBRN DEFENSE PRINCIPLES .....	B-4
	WARNING SYSTEMS .....	B-6
	MATERIALS HANDLING EQUIPMENT (MHE) .....	B-6
	AERIAL PORTS .....	B-6
	SEA PORTS .....	B-6
	RECEPTION STAGING AND ONWARD MOVEMENT (RSO) .....	B-7
	MAIN SUPPLY ROUTES (MSRs) .....	B-7
	CONTRACTOR AND HNS CONSIDERATIONS .....	B-8
	<b>SECTION IV – FIRE SUPPORT .....</b>	<b>B-8</b>
	FIRE SUPPORT CONSIDERATIONS .....	B-8
	<b>SECTION V – PROTECTIVE MEASURES .....</b>	<b>B-8</b>
	PROTECTIVE MEASURES .....	B-8
	<b>SECTION VI – CONVOY SECURITY .....</b>	<b>B-10</b>
	<b>SECTION VII – BASES AND BASE CLUSTERS .....</b>	<b>B-14</b>
	INDIVIDUAL UNIT COMMANDERS .....	B-15
	BASE COMMANDER .....	B-15
	BASE CLUSTER COMMANDER .....	B-15
	BASE AND BASE CLUSTER DEFENSE PLAN .....	B-15
	AREA DAMAGE CONTROL .....	B-16
<b>Appendix C</b>	<b>LOGISTICS REPORTING .....</b>	<b>C-1</b>
<b>Glossary</b>	.....	<b>GLOSSARY-1</b>
<b>References</b>	.....	<b>REFERENCES-1</b>
<b>Index</b>	.....	<b>INDEX-1</b>

## Figures

Figure 1-1. Notional TSC Organization.....	1-3
Figure 1-2. Notional Support Operations in a Developed Theater of Operations .....	1-4
Figure 1-3. Modular Logistics Relationship Chart for EAB Units.....	1-5
Figure 1-4. Modular Logistics Relationship Chart for Brigades and Below .....	1-6
Figure 1-5. Sustainment Brigade and Divisional Boundaries.....	1-9
Figure 2-1. A Notional Sustainment Brigade .....	2-2
Figure 2-2. Capabilities Augmentation Possibilities.....	2-3
Figure 2-3. Transportation Theater Opening Element (TTOE).....	2-6
Figure 2-4. Replenishment Operations.....	2-11
Figure 2-5. Operational Distances .....	2-12
Figure 2-6. Sustainment Brigade Staff Organization .....	2-14
Figure 2-7. Sustainment Brigade SPO .....	2-16
Figure 2-8. Notional Special Troops Battalion .....	2-26
Figure 2-9. Placement of Financial Management Organizations .....	2-29
Figure 2-10. Placement of Human Resources Organizations .....	2-30
Figure 2-11. Modularity Materiel Management Migration .....	2-33
Figure 2-12. Materiel Management Agencies and Functions Throughout the Theater of Operations .....	2-35
Figure 2-13. Requirements Flow .....	2-36
Figure 3-1. C2 Automation Systems and BCS3 .....	3-4
Figure 4-1. Notional Sustainment Brigade.....	4-3
Figure 4-2. The CSSB Headquarters.....	4-4
Figure 4-3. Support Maintenance Company.....	4-6
Figure 4-4. Component Repair Company.....	4-7
Figure 4-5. Class I and Field Feeding Operations.....	4-9
Figure 4-6. Example of Water Distribution in a Mature Theater of Operations .....	4-10
Figure 4-7. Supply Distribution for General Supplies .....	4-11
Figure 4-8. Quartermaster Support Company .....	4-12
Figure 4-9. Fuel Operations .....	4-14
Figure 4-10. POL Supply Battalion Headquarters .....	4-14
Figure 4-11. Quartermaster Petroleum and Terminal Operations Company .....	4-15
Figure 4-12. Quartermaster POL Support Company.....	4-16
Figure 4-13. Ammunition Support.....	4-17
Figure 4-14. Ammunition Battalion Headquarters .....	4-18
Figure 4-15. Ammunition Ordnance Company .....	4-19
Figure 4-16. Class VII Operations .....	4-20
Figure 4-17. Class VIII Distribution .....	4-21
Figure 4-18. Class IX Operations .....	4-22

Figure 4-19. Mortuary Operations .....	4-24
Figure 4-20. Mortuary Affairs Collection Company .....	4-25
Figure 4-21. QM Mortuary Affairs Company .....	4-25
Figure 4-22. Hygiene and Field Services .....	4-26
Figure 4-23. Field Service Company .....	4-27
Figure 4-24. Surface Transportation Request Process.....	4-28
Figure 4-25. Modularity Movement Control Migration .....	4-29
Figure 4-26. Modularity Transportation Management Migration .....	4-30
Figure 4-27. Movement Control Battalion Headquarters .....	4-35
Figure 4-28. Motor Transportation Battalion Headquarters .....	4-36
Figure 4-29. Transportation Terminal Battalion.....	4-37
Figure 4-30. Light-medium Truck Company.....	4-38
Figure 4-31. Medium Truck Company.....	4-39
Figure 4-32. Combat HET Company.....	4-40
Figure 4-33. Heavy Watercraft Company.....	4-41
Figure 4-34. Medium Boat Detachment .....	4-41
Figure 4-35. Seaport Operations Company .....	4-42
Figure 4-36. Modular Causeway Company.....	4-43
Figure 4-37. Floating Craft Company .....	4-43
Figure 4-38. Inland Cargo Transfer Company .....	4-44
Figure 4-39. CRSP Concept of Operations.....	4-46
Figure 4-40. CRSP During Offensive Operations .....	4-46
Figure 4-41. Truck Stop Convoy Support Center.....	4-48
Figure 4-42. Mini-Mart Convoy Support Center .....	4-49
Figure 4-43. Pit Stop Convoy Support Center.....	4-50
Figure B-1. Notional Mobility Enhancement Brigade Movement Corridors .....	B-12
Figure C-1. Sample Class III (B) Input Report .....	C-3
Figure C-2. Sample Class V Input Report.....	C-4
Figure C-3. Sample Combat Power Report .....	C-5
Figure C-4. Sample Class III (b) Excel Format .....	C-6
Figure C-5. Sample Class V Excel Format .....	C-7

# Preface

This field manual interim (FMI) describes the organization, mission, and operations of the sustainment brigade and its subordinate functional and multifunctional units. These subordinate units are task organized to the sustainment brigade depending on the specific mission of the brigade. This manual also describes the relationships of the sustainment brigade and its subordinate units to each other and to the organizations they have command and support relationships with as well. This manual applies to the full spectrum of operations extending from stable peace to general war. Doctrine is not intended to cover garrison operation.

This manual provides guidance for Army commanders, geographic combatant commanders (GCCs), joint force commanders (JFCs), and logisticians throughout the Army. This field manual interim (FMI) serves as an authoritative reference for students and personnel who –

- Develop doctrine materiel (fundamental principles and TTP) and force structure.
- Develop institutional and unit training.
- Develop standing operating procedures (SOP) for unit operations.

This publication applies to the Active Army, the Army National Guard/Army National Guard of the United States, and the United States Reserve unless otherwise stated.

The proponent for this manual is the United States Army Training and Doctrine Command. The preparing agency is the United States Army Combined Arms Support Command (USACASCOM). Send comments and recommendations on Department of the Army (DA) Form 2028 (Recommended Changes to Publications and Blank Forms) to Commanding General, USACASCOM, ATTN: ATCL-CDC-DA, 3901 A Avenue, Fort Lee, Virginia 23801-1809.

Unless this publication states otherwise, masculine nouns and pronouns do not refer exclusively to men.



## Chapter 1

# THE ROLE OF THE SUSTAINMENT BRIGADE IN ARMY OPERATIONS

In response to the challenge of transforming into an expeditionary Army, the modular force was designed. To compliment the modular force, the Modular Force Logistics Concept was developed to provide commensurate increased operational flex and unity of command. For the logistician, this involved streamlining traditional systems for command and control (C2), theater opening, and theater distribution. Logisticians today must be prepared to conduct a wide-ranging array of concurrent operations to support deployment, employment, sustainment, redeployment, and reconstitution. This command structure is enabled by visibility of the distribution system, its contents, and theater infrastructure. This includes visibility of main supply routes (MSRs) in concert with multi-nodal and multi-modal operations that form the backbone of the system. Logistics planners are provided the capability to identify, prioritize, and modify routes for personnel, equipment, and supplies moving throughout the distribution network. Commanders combine visibility of the distribution system with clear lines of C2 to channel assets as they move throughout the operational environment.

### SECTION I – THEATER OPERATIONAL ENVIRONMENT

1-1. In the recent past, the nature of operational environments changed significantly. This section addresses these changes and how the Army has adapted to accommodate them. One key feature is a distribution system that relies on visibility and flexibility instead of mass. The sustainment brigade is a key element in providing support and services to warfighting units to ensure freedom of action, extended operational reach, and prolonged endurance.

#### CHANGES IN THE OPERATIONAL ENVIRONMENT

1-2. Commanders must be prepared and able to conduct operations in permissive, uncertain, and hostile environments. These environments are likely to comprise difficult terrain, adverse climates, and adaptive enemies. Within the context of social, physical, and economic conditions characteristic of failed states and fractured societies, commanders may expect rampant crime with international linkages as well as religious and ethnic tension. This environment is further characterized by:

- A complex, noncontiguous battlefield, where boundaries will not be clearly defined.
- A threat scenario in which potential adversaries are not readily identifiable.
- Simultaneous, geographically dispersed operations that will result in extremely long and potentially unsecured lines of communications (LOCs).
- The prevalence of joint organizations at the operational level and single service organizations operating in a collaborative or interdependent joint environment at the tactical level.
- A significant degree of joint and single service interaction with other governmental and non-governmental organizations (NGOs), multinational forces, and contractors.

## **THEATER OF OPERATIONS**

1-3. A theater of operations is a geographical area for which a Geographic Combatant Commander (GCC) is assigned military responsibility. The command views a theater of operations from a strategic perspective and assesses the level of international military cooperation available with the degree of dedicated US military resources necessary. These factors influence prospective Army operations in each theater of operations or GCC area of responsibility (AOR).

### **DESIGNATION OF THE AREA OF OPERATIONS**

1-4. To conduct operations within its geographic area of responsibility, the GCC may designate a specific area within the AOR as a theater of war, theater of operations, or a joint operations area (JOA). Commanders may use these terms independently or in conjunction with one another, depending on the needs of the operation. If used in conjunction, the theater of war would encompass the larger area with smaller theaters of operation and JOAs within it. Joint Publication (JP) 3-0 describes the criteria for each designation in more detail. This manual uses the more generic term area of operations (AO) to refer to any area where the commander may deploy a sustainment brigade to conduct operations. The GCC (or subordinate combatant commander) maintains responsibility for the operations of US forces in an AOR or designates a joint task force (JTF) to command forces in a designated area. The Army Service Component Commander (ASCC) provides Army forces to the joint force commander (JFC)/JTF to support those operations. JP 3-0 discusses theater organization.

## **SECTION II – COMMAND AND SUPPORT RELATIONSHIPS**

### **COMMAND RELATIONSHIPS**

#### **THEATER SUSTAINMENT COMMAND (TSC)**

1-5. The TSC is the central Army logistics C2 headquarters (HQ) in a theater of operations and the senior Army logistics HQ for the Theater Army (for example, USAREUR-7th Army, United States Army, Pacific Command--8th Army) or a JFC. The TSC consolidates many of the functions previously performed by Corps Support Commands and Theater Support Commands into a central operational echelon that is responsible for C2 of theater opening (TO), theater distribution (TD), and sustainment operations conducted in support of Army and, on order, joint, interagency, and multinational forces. The TSC is regionally focused and globally employable. Its modular design provides the TSC commander with the operational flexibility to adapt C2 as requirements develop; including deploying an Expeditionary Sustainment Command (ESC) to provide an additional measure of responsiveness, agility, and flexibility for employment. Figure 1-1 shows a notional TSC with multiple ESCs available to deploy to separate JOAs and multiple sustainment brigades to provide support to multiple AOs as required. See FM 4-93.4 for more information on the TSC.

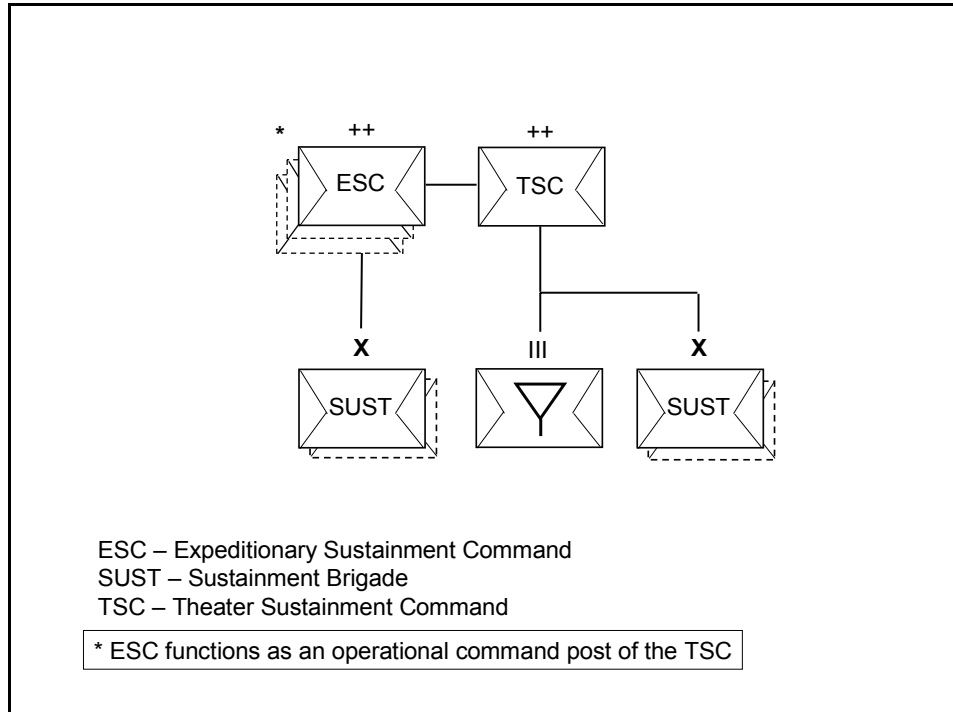

Figure 1-1. Notional TSC Organization

**Expeditionary Sustainment Command (ESC)**

1-6. The Expeditionary Sustainment Command (ESC), attached to a Theater Sustainment Command (TSC), provides command and control (C2) for attached units in an area of operation as defined by the TSC. As a deployable command post for the TSC, the ESC provides operational reach and span of control. The ESC plans and executes sustainment, distribution, theater opening and reception, staging, and onward movement for Army forces in full spectrum operations. It may serve as the basis for an expeditionary joint sustainment command when directed by the Combatant Commander or his designated Coalition/Joint Task Force Commander. The TSC establishes C2 of operational level theater opening, sustainment, distribution, and redistribution in specific areas of operation by employing one or more ESC. Each ESC provides a rapidly deployable, regionally focused, control and synchronization capability, mirroring, on a smaller scale, the organizational structure of the TSC. By design, the ESC provides C2 for operations that are limited in scale and scope; employing reach capabilities to provide augmented support where practical. The ESC also oversees TO, TD, and sustainment operations in accordance with TSC plans, policies, programs, and mission guidance.

1-7. The TSC may operate from a command center located in sanctuary, employing one or multiple ESC to establish a forward presence to control and direct deployed units. Mission, enemy, terrain and weather, troops and support available - time available and civil (METT-TC) considerations such as operational pace, span of control, conflict escalation, or operational environment may result in the deployment of the TSC to a forward area. When this occurs, the ESC may redeploy or it may be assigned another mission within the theater of operations. See FM 4-93.4 for more information on the ESC.

**Sustainment Brigades**

1-8. The sustainment brigades consolidate selected functions previously performed by corps and division support commands and area support groups into a central operational echelon and provide C2 of TO, TD, and sustainment operations. Greater detail on these missions and organization of the sustainment brigade is provided in the remainder of this manual. Combat Sustainment Support Battalions (CSSB) are the building blocks of the sustainment brigades. Their designs are standardized and can consist of up to eight

companies. CSSBs are modular and task organized to support TO, TD, area sustainment, or life support missions. Figure 1-2 depicts the support relationships that might exist in a developed theater of operations.

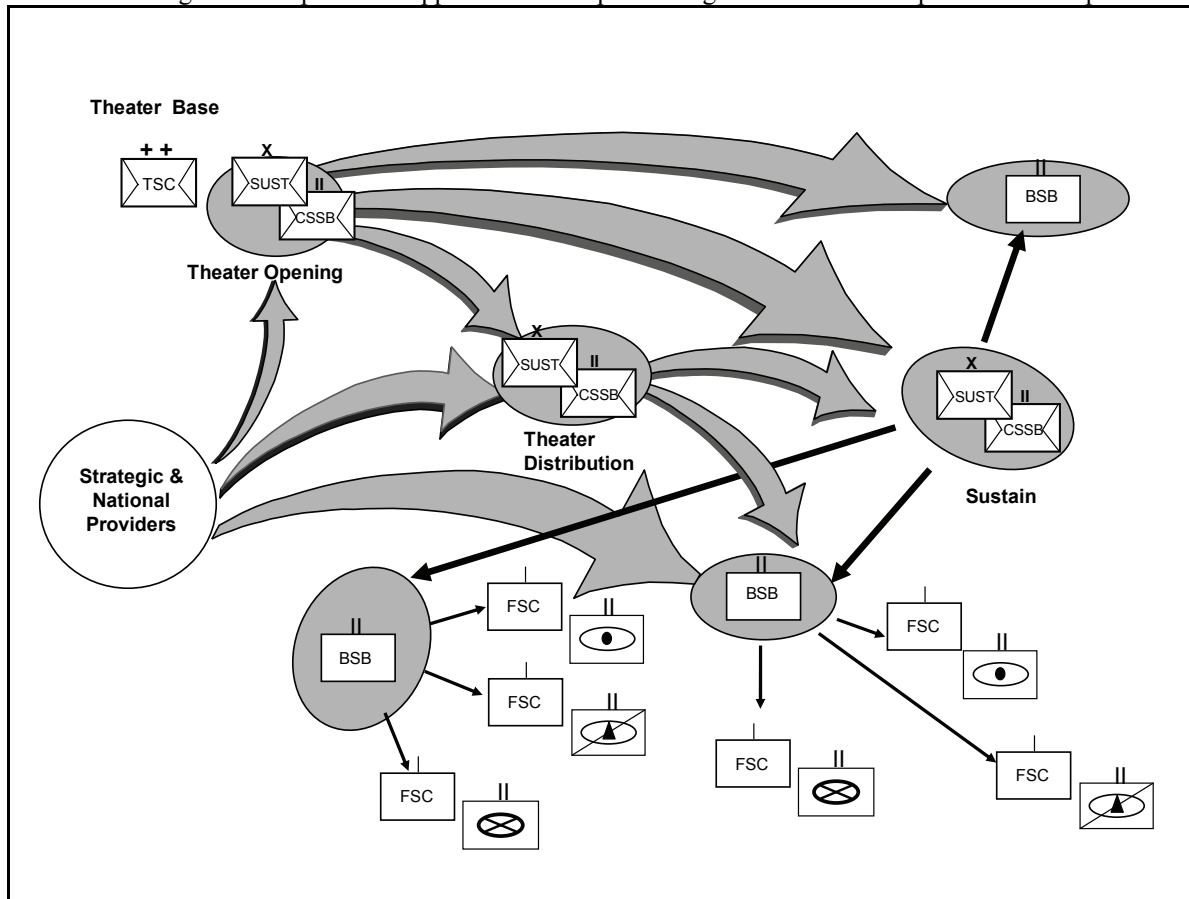

Figure 1-2. Notional Support Operations in a Developed Theater of Operations

## SUPPORT RELATIONSHIPS

1-9. Per FM 3-0, in the Army, support is a specified relationship whereas in JP 3-0 support is a joint command relationship. Support is the action of a force that aids, protects, complements, or sustains another force in accordance with a directive requiring such action. The primary purpose of the support relationship is to indicate which commanders are providing support to a designated command/organization. Designation of a support relationship does not provide authority to organize and employ commands and forces, nor does it include authoritative direction for administrative and logistics support. Table B-3 in FM 3-0 demonstrates inherent responsibilities for support relationships.

1-10. Commanders establish support relationships when subordination of one unit to another is inappropriate. They assign a support relationship when—

- The support is more effective when the supporting unit is controlled by a commander with the requisite technical and tactical expertise.
- The echelon of the supporting unit is the same as or higher than that of the supported unit. For example, the supporting unit may be a brigade and the supported unit may be a battalion. It would be inappropriate for the brigade to be subordinated to the battalion, hence the use of an Army support relationship.
- The supporting unit may provide support to several units simultaneously. Prioritization of requirements is an essential function of command, as assigning support relationships is an aspect of mission command.

**RELATIONSHIPS OF ECHELONS ABOVE BRIGADE (EAB) SUSTAINMENT UNITS**

1-11. The parent organization of the TSC is the Theater Army. The ESC is intended to be an operational command post of the TSC, but may be employed as a separate echelon of command. When employed as a separate command, the ESC may need augmentation from the TSC as determined through mission analysis. The sustainment brigade is assigned to the TSC, or the ESC when employed as a separate command. Any of these EAB support units may be placed under tactical control (TACON) of a combined arms HQ for a specific purpose such as protection or METT-TC. CSSBs and functional battalions are assigned to the sustainment brigade. The TSC is assigned to support a particular theater of operations. Sustainment brigades and their CSSBs provide support on an area basis and may also be assigned specific units to support. In a small operation and in the absence of an ESC, a sustainment brigade may be the senior logistical C2 HQ in a JOA and may be TACON to the senior maneuver HQ. During theater opening operations, the sustainment brigade may also provide C2 for all units in their AO (such as MPs, engineer, or chemical) as directed by an OPORD and in the absence of their brigade HQ. The TSC, ESC, sustainment brigade, and CSSB are in a general support relationship to the ARFOR, Corps as JTF, Division, brigade combat teams (BCT), and functional Brigades (see also JP 3-0 and FM 3-0). Figure 1-3 contains a table depicting these relationships in graphical form.

Unit <sup>9</sup>	Parent Org	ARFOR <sub>1</sub> in JOA	Corps as JTF	Division	BCT & Support BDE
TSC <sup>2</sup>	Theater Army	GS <sup>2/3</sup>	GS	GS	GS
TSC/TSC (-) <sup>4</sup>	Theater Army	GS <sup>4/5</sup>	GS <sup>6</sup>	GS	GS
ESC <sup>6/7</sup>	TSC	GS	GS	GS	GS
SUST	TSC	GS	GS	GS <sup>8</sup>	GS
CSSB / Functional Bn	SUS BDE	GS	GS	GS	GS

All of the logistics units listed here are assigned to the TSC. This chart describes the support relationships that typically exist within a theater of operations.

1 – Level of command designated as ARFOR is irrelevant (i.e. Corps, Division, etc.).  
 2 – TSC operating from home station or in sanctuary at theater level.  
 3 – "GS" is a specified relationship, see JP 3-0 and FM 3-0.  
 4 – TSC deployed in part or whole.  
 5 – Listed in OPORD Annex A as TSC(-).  
 6 – Army units are assigned to the ARFOR, not to the JTF.  
 7 – Acting as forward command post of TSC.  
 8 – GSs DIV(s) and non-DIV elements on an area basis as assigned.  
 9 – Any of these EAB GS units may be TACON for a specific purpose such as force protection, METT-TC.

**Figure 1-3. Modular Logistics Relationship Chart for EAB Units**

**RELATIONSHIPS FOR BRIGADES AND BELOW**

1-12. The heavy BCT, infantry BCT, and the fires brigade have organic Brigade Support Battalions (BSBs) and Forward Support Companies (FSCs). The FSCs are assigned to the BSB and can be in direct support, operational control (OPCON), attached, or assigned to the supported battalions. Combat aviation brigades also have organic BSBs and FSCs, but the FSCs are assigned to the supported aviation battalions. The Striker Brigade Combat Team (SBCT) has an organic BSB, but no FSCs. The SBCT task organizes

support packages into forward logistics elements to provide support similar to that of an FSC. The Maneuver Enhancement Brigade (MEB) has organic BSBs and FSCs. Within the MEB, engineer battalions have FSCs, but military police (MP) and chemical battalions do not. The engineer battalions are the parent of the FSCs. Support to the Battlefield Surveillance Brigade (BFSB) comes from a brigade support company assigned directly to the BFSB. The sustainment brigades have neither BSBs nor FSCs. Figure 1-4 contains a table depicting these relationships in graphical form.

Bde Type	organic BSB <sup>1</sup>	organic FSC <sup>1</sup>	FSC'S Parent <sup>2</sup>	FSC to BSB Relationship <sup>3</sup>	FSC to SPT'd BN Relationship <sup>4</sup>
H/IBCT	Yes	Yes	BSB	Assigned	DS/OPCON/Attached
SBCT	Yes	No <sup>5</sup>	N/A	N/A	N/A
SUST	No	No	N/A	N/A	N/A
FIRES	Yes	Yes	BSB	Assigned	DS/OPCON/Attached
AVN Bde	Yes	Yes	AV Bn	DS <sup>6</sup>	Assigned
MEB	Yes	Yes <sup>7</sup>	EN Bn	DS <sup>6</sup>	Assigned
BFSB	No	BSC	N/A <sup>8</sup>	N/A <sup>8</sup>	N/A

1- These 2 columns address which BDEs have BSBs and FSCs  
 2- Addresses what unit the FSC is assigned to.  
 3 - Addresses the relationship between the FSC and the BSB.  
 4 - Defines the likely command or support relationship that may exist between the FSC and the unit it supports.  
 5 - The SBCT task organizes support packages into forward logistics elements (FLEs).  
 6 - 'DS' means that the BSB provides replenishment to the FSC, but no formal relationship exists.  
 7 - Engineers battalions have FSCs, but MP and chemical battalions do not.  
 8 - Support to BFSB comes from a Bde Support Company assigned directly to BFSB; there is no BSB or FSC.

**Figure 1-4. Modular Logistics Relationship Chart for Brigades and Below**

## PRIORITIES OF SUPPORT AND UNITY OF EFFORT

1-13. From the President, Secretary of Defense, and GCCs, on down to divisions; commanders communicate their requirements and priorities for support through commander's intent, orders, the planning process, and briefings/conferences (see FM 3-0 for in-depth discussion). While doing so, they also ensure that coordination occurs not only with subordinate units, but also with their higher HQ and laterally to units which may be called upon to perform in a supporting role. Commanders at all levels continually ensure cohesiveness and unity of effort. Under the concept of centralized logistics C2, the TSC/ESC supports the GCC or JTF commander by ensuring that all actions throughout the theater of operations or JOA, for which the TSC/ESC is responsible, continually support unified action and reinforce the commander's intent. Commanders at all levels must ensure that the supported commander has confidence in the concept of support and that supporting plans enable the objectives of the supported commanders. They do this by continuous coordination, to include attending battlefield update briefings and commanders' conferences of both the supported commander and their own higher HQ (or sending appropriate command representation). Additionally, assigning liaison officers to the supported commander's planning staff provides unity of effort and ensures that the supporting commander is knowledgeable of future operations and of the supported commander's intent throughout the planning cycle.

We have learned in OEF (*Operation Enduring Freedom*) and OIF (*Operation Iraqi Freedom*) that the support command relationship is probably the most powerful command relationship in terms of gaining access to additional capabilities. It provides the authority and basis for interdependence, and may be the most appropriate in today's operational environment. This support relationship in essence makes the supporting commanders responsible for the success of the supported commander. They can't simply provide some forces and walk away from the challenge. Rather, it requires them to stay involved with the supported commander and continue to aid and assist him as he conducts operations.

This support relationship allows for the horizontal integration discussed upfront in this section. The support command authority is increasingly being used to provide a supported commander access to capabilities that he doesn't own. The flexibility of this support command relationship is one of its greatest advantages. It supports decentralized execution within mission type orders and commander's intent.

GEN (Ret) Gary Luck  
"Insights on Joint Operations: The Art and Science"  
September 2006

1-14. Supporting and supported commanders must develop a collaborative environment. Although the value of face-to-face interaction is undisputed, capabilities that improve long-distance collaboration among dispersed forces can enhance both planning and execution of operations. A collaborative environment is one in which participants share data, information, knowledge, perceptions, and ideas. Collaboration provides planners with a view of the whole plan while working on various portions of a plan, which facilitates identifying and resolving conflicts early. The following are some leadership practices of supported and supporting commanders that have proven to be highly effective in the field.

**Some supported commander best practices:**

- Identify needs to supporting commanders. This is a continuing, not a one time, activity.
- Request liaison from supporting commanders to help coherently integrate supporting capabilities in the operation.
- When there are issues with the quality of support, bring it to the attention of the supporting commander first and to the next higher HQ only if the issue is not resolved.

**Some supporting commander best practices:**

- Recognize the supporting unit's role in ensuring the success of the supported commander.
- Believe and follow through on the 'one team/one fight' vision to set the conditions for success.
- Understand and respect the authority of the supported commander.
- Recognize that, at times, support to another supported commander may have an even higher priority than the direct support mission (as directed by the TSC/ARFOR).
- Take time in ascertaining supported commanders' requirements and understanding the overall priorities in apportioning of forces to accomplish both assigned tasks and those of other supported commanders.
- Send liaisons to supported commanders to assist them in planning and in ascertaining their requirements.
- Develop appropriate command relationships with subordinate units to ensure all responsibilities are fulfilled. Just as close proximity is important with supported commanders; ensure subordinate commanders are kept apprised of the whole operation and the role of their unit in the theater operation.
- Mentor subordinate commanders.

1-15. Because the AO of the sustainment brigades are no longer along divisional boundaries, but rather are METT-TC, one sustainment brigade may provide support to more than one division (or major combat force) and also more than one sustainment brigade may provide support to forces belonging to a single

division. If more than one division is supported by one sustainment brigade, the TSC, in concert with the ASCC plan, will clarify which division has the priority of effort and will ensure that the sustainment brigade is updated as priorities change. In the instance of more than one sustainment brigade providing support to forces belonging to a single division, the division commander should have to coordinate and request support from only one sustainment brigade with courtesy copy to the TSC/ESC. The two sustainment brigades then coordinate their actions for support. This is to ensure optimum and continuing support and instill confidence in the division commander. It should be transparent to the division commander that more than one sustainment brigade is providing support. Normally the sustainment brigade assigned to provide direct support to the division will also be performing the Manager Review File (MRF) and Routing Identifier Code-Geographic (RIC-GEO) management for the entire division, while the other sustainment brigade delivers the supplies. During RSOI, the sustainment brigade performing theater opening will provide life support and C2 to any unit undergoing the RSOI process, especially if the unit is without its HQ. Likewise the sustainment brigade operating a major hub in the theater distribution role will provide distribution direct to the ultimate consignee where possible.

#### **SUPPORT RELATIONSHIPS DURING OPERATION IRAQI FREEDOM**

**Unlike previous Army operations where one DISCOM was assigned per division, in OIF, sustainment brigades were assigned to provide support on an area basis to all units present in the area. The sustainment brigade commanders had to ensure that needed support was provided and the division or other supported commanders had confidence in the quality of support.**

**Due to terrain and other considerations, sustainment brigade commanders found themselves providing support across divisional boundaries with one brigade providing all the support to division A except for one BCT which was physically closer to a second sustainment brigade. The second sustainment brigade provided support to the BCT of division A while being in direct support of division B. Figure 1-5 depicts this concept that sustainment brigades' AOs may not coincide with divisional boundaries, but may, in fact, overlap divisional boundaries with two sustainment brigades providing support to units subordinate to one division.**

**The sustainment brigade commanders decided that the unit which was providing support should be completely transparent to the division commanders. The sustainment brigade commander providing the majority of support to the division was responsible for division BUB attendance and for briefing the division commander of the plan of support. The sustainment brigade commanders kept each other apprised of overlapping responsibilities. The BCT's BSB provided requirements directly to the second sustainment brigade with copy furnished to the first sustainment brigade.**

**All sustainment brigade commanders reported that they operated across the JOA when necessary with positive results. The ESC approved DIRLAUTH for the sustainment brigades which the commanders used to full advantage providing support to each others' customers and operations as conditions changed and forces surged.**

**Source: Oral History of Various Sustainment Brigade Commanders**



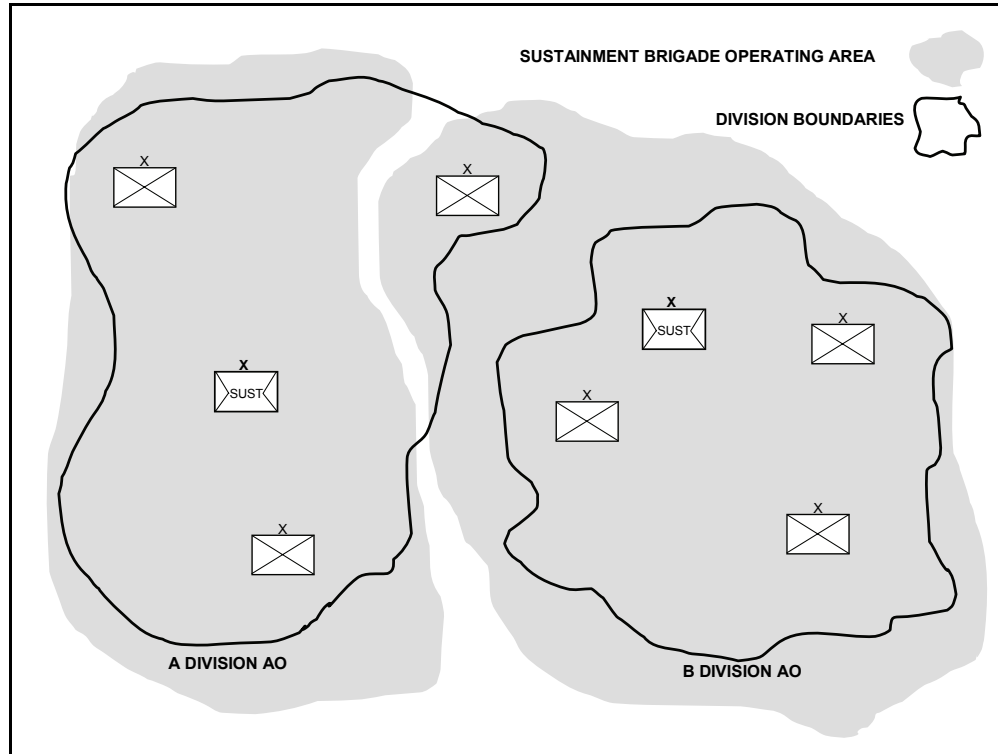

Figure 1-5. Sustainment Brigade and Divisional Boundaries

## SECTION III – STRATEGIC LEVEL SUPPORT ORGANIZATIONS

1-16. Strategic level support embraces national level sustainment base capabilities that support the broad goals and objectives that the President and Secretary of Defense establish in national security policies. At the theater level the TSC/ESC coordinate with elements of strategic level organizations to ensure a smooth flow of support into and throughout the theater of operations. In almost all operations, elements of the national strategic organizations deploy to the theater of operations to enhance this coordination. Sustainment brigades, in particular when performing theater opening operations, will work together with the subordinate units of these strategic organizations. Also when the sustainment brigade is the senior Army LOG C2 HQ in an AOR, the brigade will be coordinating directly with deployed elements from these strategic providers. Some of these elements, from strategic partners such as the United States Army Materiel Command (USAMC) and the Defense Logistics Agency (DLA) work closely with, and in some cases have deployed subordinate elements which have a command or support relationship with the TSC/ESC and sustainment brigades as described below. The US Transportation Command (USTRANSCOM) and subordinate elements also work closely with the Sustainment Brigade in its execution of theater opening operations, described in detail in Chapter 2.

### US TRANSPORTATION COMMAND (USTRANSCOM)

1-17. USTRANSCOM provides air, land, and sea transportation for the Department of Defense (DOD), both in time of peace and in time of war through its component commands: the Air Force's Air Mobility Command, the Army's Military Surface Deployment and Distribution Command, and the Navy's Military Sealift Command. The command maintains the capability to rapidly open and manage common-use aerial ports and seaports for the GCC. The contributions of USTRANSCOM's component commands are discussed below.

### **AIR MOBILITY COMMAND (AMC)**

1-18. AMC provides strategic and tactical airlift, air refueling, and aeromedical evacuation services for deploying, sustaining, and redeploying US forces, including rapidly employing aerial ports around the world. The AMC also contracts with commercial air carriers through Civil Reserve Air Fleet and other programs for movement of DOD passengers and cargo. The sustainment brigade will receive airlift schedules from and coordinate strategic air movements with representatives of AMC.

### **MILITARY SEALIFT COMMAND (MSC)**

1-19. MSC provides sealift transportation services to deploy, sustain, and redeploy US forces around the globe with a fleet of government-owned and chartered US-flagged ships. MSC executes Voluntary Intermodal Sealift Agreement contracts for chartered vessels. Sealift ships principally move unit equipment from the US to theaters of operation all over the world. In addition to sealift ships, MSC operates a fleet of prepositioned ships strategically placed around the world and loaded with equipment and supplies to sustain Army, Navy, Marine Corps, Air Force, and DLA operations. These ships remain at sea, ready to deploy on short notice, which significantly reduces the response time for the delivery of urgently needed equipment and supplies to a theater of operation. The sustainment brigade and the Army Field Support Brigade (AFSB) will receive sealift schedules from and coordinate Army Prepositioned Stocks (afloat) activities with representatives of MSC.

### **MILITARY SURFACE DEPLOYMENT AND DISTRIBUTION COMMAND (SDDC)**

1-20. SDDC provides ocean terminal, commercial ocean liner service, and traffic management services to deploy, sustain, and redeploy US forces on a global basis. The command is responsible for surface transportation and is the interface between DOD shippers and the commercial transportation carrier industry. The command also provides transportation for troops and materiel to ports of embarkation in the US and overseas and manages sea ports worldwide, coordinating for onward movement with the sustainment brigade.

### **JOINT TASK FORCE – PORT OPENING (JTF-PO)**

1-21. The JTF-PO is a joint capability designed to rapidly and initially operate aerial ports of debarkation, establish a distribution node, and facilitate port throughput within a theater of operations. The JTF-PO is not a standing task force, but is a jointly trained, ready set of forces constituted as a joint task force at the time of need.

1-22. The JTF-PO facilitates joint reception, staging, onward movement, and integration and theater distribution by providing an effective interface with the theater JDDOC and the sustainment brigade for initial aerial port of debarkation (APOD) operations. Its capabilities include:

- APOD assessment.
- APOD opening and initial operation.
- Movement control including coordination for onward movement of arriving cargo and passengers.
- Establishment of joint in-transit visibility and radio frequency identification network.
- Moving cargo up to 10 miles to a designated location for handover to the sustainment brigade for onward movement.

1-23. The JTF-PO is designed to deploy and operate for 45 to 60 days. As follow-on theater logistic capabilities arrive, the JTF-PO will begin the process of transferring mission responsibilities to arriving sustainment brigade forces or contracted capabilities to ensure the seamless continuation of airfield and distribution operations.

## **JOINT DEPLOYMENT DISTRIBUTION OPERATIONS CENTER (JDDOC)**

1-24. The JDDOC is a joint capability designed to support GCC operational objectives by assisting in the synchronization of strategic and theater resources to maximize distribution, force deployment, and sustainment. Its goal is to maximize GCC combat effectiveness through improved total asset visibility.

1-25. The JDDOC, under the control and direction of the GCC, directs, coordinates, and synchronizes forces' deployment and redeployment execution and strategic distribution operations to enhance the GCC's ability to effectively and efficiently build and sustain combat power. The JDDOC is an integral component of the GCC staff, normally under the direction of the GCC Director of Logistics (J4). However, GCC's can place the JDDOC at any location required or under the operational control of another entity in the GCC area of responsibility. The JDDOC will normally be coordinating with the TSC/ESC, but on small scale operations, may be coordinating directly with a sustainment brigade operating as the senior Army LOG C2 HQ in the theater of operations.

## **DEFENSE LOGISTICS AGENCY (DLA)**

1-26. DLA is the DOD's primary strategic-level logistics provider and is responsible for providing a variety of logistics support to the military services. DLA has the capability of providing a forward presence in the operational area via its DLA contingency support teams (DCSTs). DLA normally provides a DCST to each major joint operation to serve as the focal point for coordinating DLA support. The DLA DCSTs may either collocate with the joint force commander J-4, the TSC Distribution Management Center (DMC), or the AFSB when the Army is the lead Service for significant common user logistics (CUL) support. The in-theater DCST integrates strategic to operational level materiel management support of DLA common commodities such as subsistence, clothing and other general supplies, Class IV construction/barrier materiel, package/bulk petroleum, and medical materiel.

1-27. DLA also provides in-theater defense reutilization and marketing services. DLA assists the joint force commander J-4; establishes theater specific procedures for the reuse, demilitarization, or disposal of facilities, equipment, and supplies, to include hazardous materiel (HAZMAT) and waste. Initially, salvage and excess materiel is collected in the main theater distribution point and/or the brigade support areas as the situation permits. As the theater of operations matures, this materiel is evacuated to collection points for inspection and classification. The TSC or sustainment brigade coordinates with Defense Reutilization and Marketing Service to perform distribution management operations for the Army forces.

## **US ARMY MATERIEL COMMAND (USAMC)**

1-28. USAMC support to deployed Army forces is coordinated via the Army Sustainment Command (ASC) and is executed in the operational area by the Army Field Support Brigade (AFSB) and Contracting Support Brigade (CSB). The AFSB, when deployed, will be OPCON to the TSC and responsible for planning and controlling all USAMC and other acquisition logistics and technology (ALT) functions in the operational area less theater support contracting. The CSB, when deployed, will also be OPCON to the TSC and responsible for theater support contracting.

## **OPERATIONAL CONTRACT AND OTHER ACQUISITION, LOGISTICS, AND TECHNOLOGY SUPPORT**

1-29. Acquisition, logistics, and technology (ALT) support consists of a numerous unique support functions in a deployed AO to include rapid equipment fielding support, technical equipment support, prepositioned stock support, and contracting support. Most of this ALT support is conducted through two O-6 level USAMC units: the Army Field Support Brigade (AFSB) and the Contracting Support Brigade (CSB). AFSB and CSB provide support to the sustainment brigade under the C2 of the TSC or ESC. The exception to this doctrinal rule of thumb is when the sustainment brigade is the senior Army LOG C2 HQ in the AO. In this situation, the ARFOR commander may choose to OPCON AFSB and CSB elements to the sustainment brigade.

## THE ARMY FIELD SUPPORT BRIGADE (AFSB)

1-30. The AFSB is the primary ALT unit for the Army and is responsible to control all ALT functions, less theater support contracting and Logistic Civil Augmentation Program (LOGCAP) support, in the AO. The AFSB is a small table of organization and equipment (TOE) and augmented table of distribution and allowances (TDA) HQ that leverages reach (for technical support) and call-forward procedures to bring the requisite USAMC and Assistant Secretary of the Army for Acquisition, Logistics, and Technology (ASA[ALT]) program executive officers (PEOs) (such as, PEO Ground Combat Systems) and their subordinate product/project managers (PMs) (such as, PM Stryker Brigade Combat Team) capabilities forward to the AO. These capabilities are organized in a USAMC-wide contingency TDA consisting of nearly 2,000 personnel. Specific AFSB functions include, but are not limited to:

- Army Logistics Assistance Program (LAP) support.
- System support contract management.
- Army Preposition Stocks (APS) offload support.
- USAMC research and development call forward support.
- USAMC Life Cycle Management Command (LCMC) call forward support.
- PM/PEO rapid-fielding and equipment modification support.
- Contractor personnel accountability and deployment support.

1-31. Two key AFSB subordinate units are the Army Field Support Battalion (AFBN) and the brigade logistics support team (BLST). AFSBNs are small, tailorable, deployable, O-5 level TDA organizations of approximately 22 personnel, mostly LCMC logistics assistant representatives (LARs), aligned to specific division HQ. BLSTs are similar to AFSBNs, but are smaller, O-4 level organizations (can also be lead by a warrant officer) that provide DS LAP support to a specific BCT or aviation brigade. Since sustainment brigades DO NOT have a DS BLST, they receive GS ALT support (less theater support contracting and LOGCAP) from a designated AFSBN commander on GS basis. Additional AFSB information can be found in FMI 4-93.41.

## CONTRACTING SUPPORT BRIGADE (CSB)

1-32. The Army has recently consolidated its theater support contracting capabilities into separate TOE units. These units include the CSB, Contingency Contracting Battalions (CCBN), Senior Contingency Contracting Teams (SCCT), and Contingency Contracting Teams (CCTs). These consolidated units are made up of primarily 51C military occupational specialty officers and noncommissioned officers. Like the AFSB, these units are currently assigned to the ASC, but are scheduled to come under the command of the new, US Army Contracting Command, and its subordinate, Expeditionary Contracting Command, in the near future. The CSB and its subordinate unit's primary missions include:

- Provide theater support contracting capabilities to deployed Army forces, as well as other military forces, governmental agencies, and/or non-governmental agencies as directed.
- Develop contracting support plans: normally at the ARFOR level. These plans will include mission specific LOGCAP support information.
- Coordinate execution of LOGCAP support to ensure it is not in competition with existing or planned theater support contracts.
- In close coordination with the supporting AFSB, provide contracting advice and planning assistance to senior maneuver and sustainment commanders.

1-33. In major operations, the CSB will normally be OPCON to the TSC or a separate joint theater support contracting command. In these situations, theater support contracting actions will provide general support to the sustainment brigade. In smaller operations, a CCBN could be placed OPCON to the sustainment brigade, if the sustainment brigade is the senior sustainment command in the AO and the CSB is not deployed. Additional CSB information can be found in FMI 4-93.42 (in development).

## **SUSTAINMENT BRIGADE'S ROLE IN PLANNING AND MANAGING OPERATIONAL CONTRACT SUPPORT**

1-34. Contracting is a key source of support for deployed armed forces across full spectrum operations. Because of the importance and unique challenges of operational contract support, the sustainment brigade commander and staff need to fully understand their role in planning for and managing contracted support in the AO. Current doctrine describes three broad types of contracted support: theater support, external support, and systems support.

### **Theater Support Contracts**

1-35. These contracts support deployed operational forces under prearranged contracts, or contracts awarded from the mission area, by contracting officers under the C2 of the CSB. Theater support contractors are employed to acquire goods, services, and minor construction support, usually from local commercial sources, to meet the immediate needs of operational commanders. Theater support contracts are the type of contract typically associated with contingency contracting. Sustainment brigades will often be the requiring activity for theater support contract support actions related to both internal and external missions. Theater support contracts in support of the sustainment brigade's missions are normally executed through a general support CCT or regional contracting office.

### **External Support Contracts**

1-36. These types of contracts provide a variety of support to deployed forces. External support contracts may be prearranged contracts or contracts awarded during the contingency itself to support the mission and may include a mix of US citizens, third-country nationals, and local national subcontractor employees. The largest and most commonly used external support contract is LOGCAP. This Army program is commonly used to provide life support, transportation support, and other support functions to deployed Army forces and other elements of the joint force as well. Depending on METT-TC factors, the sustainment brigade may or may not serve as a major requiring activity (the unit responsible to develop and assist in managing specific contract support requirements) for LOGCAP support, but in almost all operations will serve as supported unit relative to LOGCAP support. If designated by the ARFOR and/or TSC commander as the lead requiring activity for any significant LOGCAP task order support actions, the sustainment brigade would normally be augmented by an USAMC logistic support officer (LSO) from Team LOGCAP-Forward (TLF).

### **System Support Contracts**

1-37. System support contracts are pre-arranged contracts by the USAMC LCMCs and separate ASA(ALT) PEO and PM offices. Supported systems include, but are not limited to, newly fielded weapon systems, C2 infrastructure, such as the Army Battle Command Systems (ABCS) and standard Army management information system (STAMIS), and communications equipment. System contractors, made up mostly of US citizens, provide support in garrison and may deploy with the force to both training and real-world operations. They may provide either temporary support during the initial fielding of a system, called interim contracted support or long-term support for selected materiel systems, often referred to as contractor logistic support. The sustainment brigade does not normally have a significant role to play in planning for or coordinating system support contracts other than coordinating and executing support of system support contract related personnel.

1-38. For the sustainment brigade, the major challenge is ensuring theater support and external contract support (primarily LOGCAP related support) actions are properly incorporated and synchronized with the overall sustainment brigade support effort. It is imperative that the sustainment brigade SPO, with or without LSO augmentation, closely work with the TSC/ESC SPO, the ARFOR G-4, the CSB, and the supporting TLF. It is also important to understand the sustainment brigades do not have any dedicated contingency contracting officers on their staff and this support will be provided on a GS basis through the supporting CSB. Because of these new modular force contracting support arrangements, it is imperative

for the sustainment brigade staff be trained on their role in the operational contract support planning and execution process as described below:

### **Contract Planning**

1-39. The sustainment brigade must be prepared to develop “acquisition ready” requirement packets for submission to the supporting contracting activity. The packets must include a detailed performance work statement (PWS) (previously referred to as a statement of work or SOW) for service requirements or detailed item description(s)/capability for a commodity requirement. In addition to the PWS, packets must include a Letter of Justification (LOJ) or Letter of Technical Direction (LOTD) for service requirements. Depending upon command policies, certain items or specific dollar amount requests may require formal acquisition review board packet review.

### **Contract Management**

1-40. The sustainment brigade plays a key role in theater support contract and LOGCAP task order management. One of the most important sustainment brigade tasks in this process is to nominate and track contract officer representatives (CORs) (sometimes referred to as contract officer technical representatives or COTRs) for every service contract and LOGCAP task order as directed. It will also nominate a receiving official for all supply contracts. Quality COR and receiving official support is key to ensuring contractors provide the service or item in accordance with the contract. The sustainment brigade must also manage funding for each contract and request funds in advance of depletion of current funds or all contract work will stop until adequate funds are available. Finally, in some operations, the sustainment brigade will be required to provide formal input to LOGCAP award fee and performance evaluation boards.

### **Contract Close Out**

1-41. The sustainment brigade is responsible for completing receiving reports: certifying that the contracted goods or services were received by the Army. The contracting officer shall receive a copy of the receiving report from the sustainment brigade so the contract can be closed out and the contractor can be paid.

---

For general postings of questions and discussions of contracting issues on the internet, see the CASCOM battle command knowledge system on LOGNET. <https://lognet.bcks.army.mil/> Click on “Battlefield Contracting.” For online training covering basic contracting familiarization go to <https://scoe.learn.army.mil/webapps/portal/frameset.jsp>, browse the course catalogues, select “SCOE courses,” and enroll in “151-CAF-DL, Contractors Accompanying the Force (CAF).” COR training can be found on-line through the DAU website; [www.dau.mil](http://www.dau.mil). COR training is also available by attending the course taught at Fort Lee, Virginia or one taught by the support contracting activity.

---

1-42. In some major operations, the operational contract support tasks discussed above can be a major challenge for a sustainment brigade. When faced with major operational contract support management tasks, it is imperative the sustainment brigade commander organize some type of contract management cell within the S4 and/or SPO shop to ensure these tasks are properly accomplished. In long-term operations, as seen in OIF and OEF, the sustainment brigade will need to ensure direct coordination and transfer of operational contract support related information prior to relief in place/transfer of authority (RIP/TOA). Additionally, when the advance party arrives in the AO, it is essential specifically designated unit personnel actively seek out current information on local contract support capabilities, policies, and procedures. This individual must be prepared to coordinate the formal hand over of existing contract management responsibilities from the redeploying unit. It is critical to know when recurring service contracts will be ending, because it generally takes 30 to 60 days to obtain funding approval. If the unit waits until the contract is about to expire before additional funds are requested, the sustainment brigade could lose the contracted service until funds are available. The vignette below provides insight to sustainment brigade operational contract support challenges in current operations.

During operations in Iraq, the 1<sup>st</sup> Sustainment Brigade unexpectedly found itself with significant tasks related to both Logistics Civil Augmentation Program (LOGCAP) and various theater support contracts. Once confronted with this situation, the commander directed a formal mission analysis that identified significant training and organizational shortfall. In order to resolve the situation, the 1<sup>st</sup> Sustainment Brigade Commander directed the creation of a contract support coordination cell formed from internal resources within the SPO. This ad hoc section's primary mission was to focus on contracting, planning, and management activities. The contract support coordination cell was comprised of an officer in charge (O-5 level) and three sections: quality assurance, purchasing, and planning and programming with total manning of two officers and three NCOs. The cell's mission included nominating and tracking contracting officer representatives, monitoring existing support contracts, developing performance work statements and statements of work for new requirements, planning for funds to support existing and future contracts, coordinating with contracting activities such as Team LOGCAP Forward and the local regional contracting officer.

Center for Army Lessons Learned's Reverse-Collection and Analysis Team (R-CAAT) program

## SECTION IV – SUPPORT OF MILITARY, CIVILIAN, JOINT, AND MULTINATIONAL ORGANIZATIONS

1-43. The Army may operate in a joint coalition or multinational environment. The following section describes the broad roles of support involved when operating in such an environment and discusses the sustainment brigade's role in general terms.

### ORGANIZING THE JOINT FORCE

1-44. The JFC can organize forces in several different ways. The JFC directs operations through service component commanders or establishes functional commands. Such functional commands may include a joint forces land component to provide centralized direction and control of all land operations, including other Services land forces (see JP 0-2 and JP 3-31). The combatant commander or JFC may assign a lead Service to provide CUL to avoid redundancy and achieve greater efficiency (see JP 4-07).

### SUSTAINMENT BRIGADE ROLE

1-45. The TSC and/or Sustainment Brigade may be called upon to support joint and/or multinational operations. As such, the roles and missions of the Sustainment Brigade may expand to include support to other services in accordance with Title 10, and/or support to forces of other nations in accordance with bilateral and multilateral agreements. See FM 4-93.4, *Theater Sustainment Command*, JP 3-16, and JP 4-0 for further information on these types of operations.

### SETTING THE THEATER BASE

1-46. A critical component of the TSC's effort to set the theater base is its focus on organizing and positioning of capabilities to support the conduct of future operations. The sustainment brigade performing theater opening has OPCON of units processing through reception, staging, and onward movement until their HQ arrives and is operational. Key activities include: ensuring the timely arrival of deploying units in the theater of operations; coordinating support from national/strategic partners; establishing theater personnel accountability and fiscal oversight; and establishing visibility of the distribution network. The sustainment brigade must also consider and integrate the Finance Management Center and the Human Resources Sustainment Center (HRSC), including a Reception, Replacement, Rest and Recuperation, Return to Duty, and Redeployment (R5) element as appropriate.

## **BUILDING THE THEATER BASE**

1-47. The TSC expands its operational capabilities and capacity to meet the future operational requirements of the JFC. A key consideration is the establishment of interdependencies between the Services and government agencies to minimize competition for limited strategic and theater resources. Critical tasks for the sustainment brigade (TO) include:

- Provide C2 for theater opening capabilities.
- Maintain connectivity with national/strategic partners.
- Conduct reception, staging, and onward movement operations.
- Update/finalize distribution plans to ensure the JFC's concept of operations is supportable.

1-48. The TSC plans and establishes and the sustainment brigade executes the theater segment of the distribution system in coordination with USTRANSCOM and the GCC/JTF Commander. The TSC provides for the integrated support of land component forces throughout a distributed operational environment via the sustainment brigades. Critical tasks include: providing C2 for integrated inter- and intra-theater support and expanding the distribution system to build and sustain combat power for future decisive operations.

## **SETTING CONDITIONS FOR FOLLOW-ON OPERATIONS**

1-49. The TSC sets the conditions for follow-on operations by providing for the integrated support of land component forces throughout the theater of operations. It accomplishes this through the continued synchronization of distribution operations, executed by a network of sustainment brigades. It capitalizes on the inter-dependencies created between the Services and government agencies to achieve greater operational with fewer redundant capabilities.

## **FACILITATING THE REDEPLOYMENT PROCESS**

1-50. The sustainment brigade facilitates the redeployment and the retrograde process through its C2 of the distribution system, maintaining situational awareness of system capacity and leveraging joint capabilities. While many of the procedures used to deploy forces, draw pre-positioned stocks, conduct reception staging and onward movement (RSO), and distribute supplies within the theater of operations apply to the redeployment process, two factors in particular complicate redeployment operations.

- First, the same elements that operate and manage the theater distribution system during deployment and sustaining operations perform similar roles during redeployment. When redeployment and deployment and sustaining operations occur simultaneously, the TSC may find it necessary to rebalance its forces or change the missions of subordinate units to effectively support on-going operations and redeployment.
- Second, requirements vary widely depending on the nature and scale of redeployment operations, theater infrastructure, and other factors. For example, redeployment operations could range from personnel only to entire units and their equipment. Depending upon the political and military strategy, unit rotations may occur while decisive operations continue unabated or during operational transitions. Key considerations include but are not limited to: size of the force redeploying and deploying; infrastructure requirements and limitations; security requirements; traffic circulation; staging areas; distribution system capacity; quantity of supplies and materiel to be redistributed (both internally and through the Defense Reutilization and Marketing Office); the amount and kinds of material that require disposal agricultural inspections; and establishing accountability of retrograde cargo. The challenge for the sustainment brigade is effective coordination and synchronization, vertically and horizontally, to ensure responsive simultaneous support to not only on-going distributed operations, but also redeployment. R5 elements are critical to the coordination and synchronization effort.



## INTERAGENCY SUPPORT

1-51. The DOD performs both supported and supporting roles with other agencies. During combat or in humanitarian assistance operations, the DOD may likely be the lead agency and supported by other agencies. When the Army (through the DOD) is tasked to provide military support to civil authorities, its forces perform in a supporting role. The sustainment brigade may be tasked to support the local head of another agency, such as an ambassador, or may employ the resources of other US Government agencies or even private firms. Whether supported or supporting, close coordination is the key to efficient and effective interagency operations.

---

### Interagency Coordination

*Interagency coordination forges a vital link between military operations and nonmilitary organization activities. These may include governmental agencies of the United States, host nations, and partner nations. It may also include regional and international nongovernmental organizations. Theater strategies routinely incorporate the capabilities of the entire US interagency network.*

FM 1, *The Army* (June 2005)

---

1-52. The GCC controls and is accountable for military operations within a specified area of responsibility. The commander defines the parameters, requests the right capabilities, tasks supporting DOD components, coordinates with the appropriate Federal agencies, and develops a plan to achieve the common goal. Sustainment brigades may be responsible for providing sustainment to other government agencies within their assigned AOs. During the early stages of military operations in austere environments or in small operations, the sustainment brigade may be the only organization capable of providing supplies, services, and life support to other Federal elements. Operations in a military, civilian, joint, and multinational environment create challenges with regard to “in-kind” compensations required by inter-service support agreements (ISSAs). Planners and operators must be keenly aware of ISSAs as they relate to Title 10 to avoid legal issues.

1-53. Nongovernmental organizations (NGOs) do not operate within either the military or the governmental hierarchy. Their relationship with the Armed Forces is neither supported nor supporting. An associate or partnership relationship exists between military forces and engaged NGOs. If formed, the focal point where US military forces provide coordinated support to NGOs would be the civil-military operations center of a JTF HQ.

1-54. The sustainment brigade might be required to support civil operations. The commander and staff must understand roles and responsibilities in such operations. FM 1, *The Army*, defines the Army’s role during civil support operations. Civil support operations address the consequences of manmade or natural accidents and incidents beyond the capabilities of civilian authorities. Under US law, the federal and state governments are responsible for those tasks normally associated with stability and reconstruction operations. Army forces conduct civil support operations when requested, providing expertise and capabilities to lead agency authorities. During civil support operations, the Army performs a supporting role and is called upon regularly to provide assistance to civil authorities to deal with natural disasters (such as, hurricanes, floods, and fires), as well as manmade incidents (such as, riots and drug trafficking). The military is called on to perform these missions because it is able to move and organize large numbers of trained personnel to provide a coordinated response to incidents at home. Logistics support to civil support operations requires early and integrated planning among the Services, sustaining organizations like the sustainment brigade, and other federal agencies as required. For more information see JP 3-08 and JP 3-27.

## HOST NATION SUPPORT

1-55. The sustainment brigade will coordinate for HNS (negotiated by the US Department of State) or for the contracting of resources and materiel as required in support of its mission.

1-56. HNS and local procurement may provide a full range of sustainment, operational, and tactical support. HNS agreements fulfilling the command requirements for support need to be pre-negotiated. Such support arrangements must be integrated into the distribution plan and coordinated with other services, allies, and coalition partners to prevent competition for resources and ensure high priority requirements are met. HNS may include functional or area support and use of host nation facilities, government agencies, civilians, or military units. Pre-established arrangements for HNS can reduce the requirement for early deployment of US assets and can offset requirements for early strategic lift by reducing requirements for moving resources to the theater of operations.

## MULTINATIONAL SUPPORT

1-57. Multinational support may consist of CUL support provided from one multinational partner to another. One or more of the following organizational and/or management options facilitates multinational support:

- National support elements provide national support.
- Individual acquisition and cross-servicing agreements provide limited support.
- A lead nation provides specific support to other contributing nation military forces.
- A role-specialist nation provides a specific common supply item or service.
- A multinational integrated logistics unit provides limited common supply and service support.
- A multinational joint logistics center manages CUL support.

1-58. In all cases, the multinational force commander directs specific multinational CUL support within the applicable laws and regulations of the HN. When operating within a formal alliance, the sustainment brigade executes CUL support in accordance with applicable standardization agreements or quadripartite standardization agreements. FM 4-0, JP 4-07, and JP 4-08 discuss multinational logistics support.

1-59. Financial management companies may be required to provide dispersing support to multinational forces. This support may include paying agent funding and commercial vendor payment services among others.

## Chapter 2

# MISSIONS AND ORGANIZATION

The sustainment brigades are subordinate commands of the TSC, designed to provide C2 of theater opening, distribution, and sustainment within an assigned area of operation. The level of assignment and mission assigned to the sustainment brigade determine the mix of functional and multifunctional subordinate battalions under the control of the brigade. The brigades provide C2 and staff supervision of replenishment, life support activities, human resources and financial management support, and distribution management.

### SECTION I – MISSIONS AND TASKS

#### GENERAL

2-1. The major missions performed by the sustainment brigades are theater opening (TO), theater distribution (TD), and sustainment. These missions are interrelated and, throughout the course of an operation, a sustainment brigade will likely perform more than one of these functions simultaneously. This chapter discusses the organizational structures that support these missions.

2-2. The sustainment brigade is a flexible, tailorable organization. All sustainment brigade HQ are identical in organizational structure and capabilities. Organic to the sustainment brigade are the brigade HQ and a special troops battalion (STB). The core competency of the sustainment brigade is C2 of sustainment operations, providing C2 and staff supervision of life support activities and distribution management to include movement control as an integral component of the theater distribution system. During the ARFORGEN process, functional and multifunctional subordinate battalions are task organized to the sustainment brigade to enable it to accomplish its role and missions. Figure 2-1 depicts a developed theater of operations and the support relationships that might exist there.

#### MISSIONS

2-3. The sustainment brigade, attached to an ESC/TSC, provides command and control for all subordinate units, and provides sustainment in an area of operations as defined by the ESC/TSC. The sustainment brigade plans and executes sustainment, distribution, theater opening and reception, staging, and onward movement of Army forces in full spectrum operations as directed by the ESC/TSC.

2-4. All sustainment brigades have the same general capability to manage theater opening, theater distribution, and sustainment operations. Each sustainment brigade is a multifunctional organization, tailored and task organized to provide support for multiple brigade-sized or smaller units using its' subordinate battalions, companies, platoons, and teams to perform specific sustainment functions. In the sustainment role, the brigade is primarily concerned with the continuous management and distribution of stocks, human resources support, execution of financial management support, and allocation of maintenance in the AO to provide operational reach to maneuver commanders.

2-5. The sustainment brigade management tasks are coordinating and integrating personnel, equipment, supplies, facilities, communications, and procedures to support the maneuver commander's intent. The sustainment brigade may require augmentation in those areas where it lacks staff expertise and/or functional support capabilities (see Figure 2-2). For example, the TSC commander may augment the sustainment brigade with transportation units to enable it to oversee and execute port clearance and

terminal operations if the sustainment brigade is given the theater opening mission. Likewise a sustainment brigade may serve as the senior joint logistics HQ in an AO when provided augmentation commensurate to the mission. Under the modular construct, organizational designs incorporate multifunctional, self-reliant sustainment capabilities within the BCT and BSB, providing much greater self-reliance at this echelon. Each BCT, for example, carries three combat loads on organic transportation assets minimizing the need for external support, which is most likely provided by a sustainment brigade during replenishment operations. Therefore, if the sustainment brigade is supporting units which do not have this robust capability whether they are US Army units which have not transformed or are multi-national forces, the sustainment brigade and subordinates will need to be tailored to provide greater support.

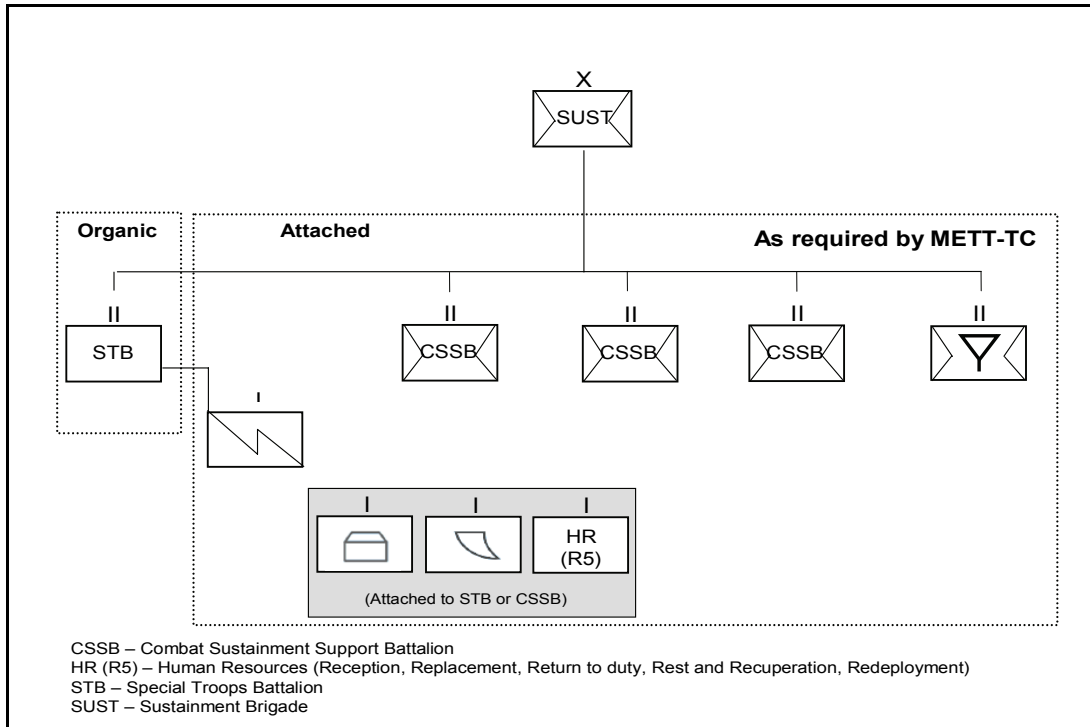
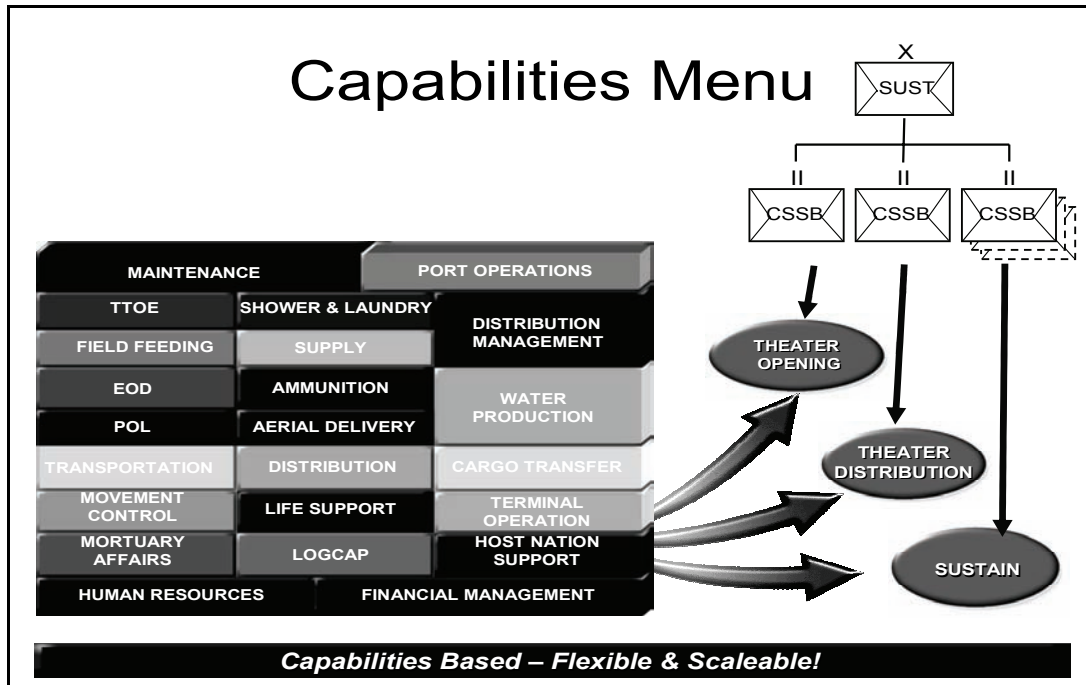

Figure 2-1. A Notional Sustainment Brigade



**Figure 2-2. Capabilities Augmentation Possibilities**

2-6. During periods where only Special Operations Forces are operating in a theater, support operations may be executed under the C2 of the Sustainment Brigade (Special Operations) (Airborne)(SB[SO][A]) which has an modification table of organization and equipment-deployable organization and is assigned to USASOC. When deployed, the SB(SO)(A) acts as the logistics HQ for a joint special operations task force (JSOTF). The SB(SO)(A) has the capability to provide technical control to Army special operations forces (ARSOF) in the planning and execution of Special Operations Forces (SOF) logistics, including Army Health System (AHS) support. The SB(SO)(A) will serve as the primary logistics operator and advisor to the USASOC Commander and will primarily focus on operational to tactical logistics support. The SB(SO)(A) will monitor and update the common operational picture (COP), synchronize and manage sustainment and distribution operations, determine and anticipate requirements, and plan, coordinate, and synchronize both current and future operations for deployed SOF units. The brigade will also integrate ARSOF support requirements into the ASCC support plan and ensure a timely response to ARSOF requirements. When required, the SB(SO)(A) may also serve as an early entry element to C2 up to one CSSB in support of a conventional force expansion in the theater of operation. See FMI 3-05.140, *Army Special Operations Forces Logistics*.

### SUSTAINMENT BRIGADE OPERATIONAL CAPABILITIES

- Provides supplies, field services, field and selected sustainment level maintenance, recovery, and field feeding for itself and its assigned subordinates.
- Plans and conducts base and base cluster self-defense. Defends against level I threats, assists in destruction of level II threats and escapes or evades against level III threats.
- Capable of operating as part of an Army or joint force.
- Coordinates host nation support (HNS) established by the Department of State.
- Capable of deploying an advance party to support early entry operations.
- Provides theater opening, theater distribution, and sustainment management information and advice to commanders and staff within its AO and the TSC.
- Exercises technical supervision over operations for all assigned units.

- Combat service support automation management office (CSSAMO) provides logistics STAMIS management, plans, policies, and procedures for logistics automations functions/systems to the sustainment brigade, area support and backup support to the BSB CSSAMOs in the support footprint.
- Provides limited materiel management for internal stocks, Class I, II (including unclassified map stocks), Class III and water, Classes IV, V, VII, and IX and maintenance management of internal assets.
- Provides a liaison team to augment other HQs as necessary.
- Manages and maintains the sustainment brigade property records.
- Maintains data in support of the Army equipment status reporting database and the Army equipment status reporting system.
- Provides human resources, financial management, legal services, and religious support to assigned units and authorized personnel within the sustainment brigade's area of responsibility.
- Appoints contracting officer representatives (COR) to monitor contractor performance, certify receipt of services, and act as liaisons between the requiring activity and the contracting officer.

## THEATER OPENING MISSION

2-7. Theater opening (TO) is the ability to rapidly establish and initially operate ports of debarkation (air, sea, and rail) to establish sustainment bases and to facilitate port throughput for the reception, staging, and onward movement of forces within a theater of operations. Although port operations are a critical component of the theater opening function, theater opening is comprised of much more: communications, intelligence, civil-military operations, services, human resources, financial management, force health protection, engineering, movement (air/land/water transport, inland terminal operations), materiel management, maintenance, and contracting. A sustainment brigade will be one of the first organizations into a theater of operations.

2-8. When given the mission to conduct theater opening, the sustainment brigade is designated a Sustainment Brigade (TO) and a mix of functional battalions and multi-functional CSSBs are assigned based on mission requirements. The sustainment brigade HQ staff may be augmented with a Transportation Theater Opening Element (TTOE) to assist in managing the theater opening mission. The augmentation element provides the sustainment brigade with additional manpower and expertise to C2 TO functions, to conduct transportation planning and provides additional staff management capability for oversight of reception, staging, onward movement, and integration (RSOI) operations, port operations, node and mode management, intermodal operations, and movement control.

2-9. Conducting efficient and effective theater opening operations requires unity of effort among the various commands and a seamless strategic-to-tactical interface. Theater opening is a complex joint process involving the GCC; strategic and joint partners such as USTRANSCOM, USAMC, and DLA. Also critical to the theater opening effort is the JDDOC which has the mission to improve in-transit visibility and to support the geographic combatant commander's operational objectives by synchronizing and optimizing the interface of inter-theater and intra-theater distribution to integrate the proper flow of forces, equipment, and supplies. In coordination with the supporting AFSB and CSB CDR or principal assistant responsible for contracting (PARC), the sustainment brigade will participate in assessing and acquiring available host nation (HN) infrastructure capabilities and contracted support. Working together, theater opening functions set the conditions for effective support and lay the groundwork for subsequent expansion of the theater distribution system.

2-10. The critical tasks for theater opening include: C2, reach and in-transit visibility; transportation management; theater RSOI; distribution and distribution management; movement control and movement

management; life support; contracting support; and initial theater sustainment. Given the mission of theater opening, a sustainment brigade, together with the TTOE, should have capabilities to conduct the following:

- Establishing the theater base and infrastructure necessary for the joint force to expand to fully developed theater distribution and support operations.
- Establishing and managing initial theater distribution operations. This includes distribution management, movement control and materiel management, and both surface and aerial re-supply operations.
- Soldier support, to include all life support services needed to support theater opening operations.
- Establish the Military Mail Terminal (MMT), Theater Gateway Reception, Replacement, Return To Duty, Rest And Recuperation, and Redeployment (TG R5) Personnel Processing Center (PPC), and initial Casualty Assistance Center during theater opening operations prior to the beginning of personnel flow, if tactically feasible.
- Financial management
- Establishing the required elements of the Army distribution system.
- Establishing and operating staging areas and/or bases.
- Establishing and operating supply support areas for staging sustainment stocks.
- Clearing incoming personnel and cargo at APODs and sea ports of debarkation (SPODs), working with USTRANSCOM elements, especially from SDDC and AMC.
- Designating and preparing routes for onward movement (in conjunction with the respective engineer coordinator).
- Coordinating movement within the theater of operations with the Movement Control Battalion (MCB).
- Identifying and occupying the real estate needed for marshaling areas and the theater staging bases.
- Establish initial financial management support operations in order to provide commercial vendor services support, banking and currency support, paying agent support, and limited pay support.
- Establishing C2 links to provide in-theater connectivity among tactical, joint, and strategic support systems for integrating initial Army force deployments.
- Planning operational support area RSO&I nodes in conjunction with the ARFOR staff.
- Assist in developing and executing the Army portions of the joint movement program developed by the Joint Movement Center.
- Establishing connectivity with Global Transportation Network that receives data from the Worldwide Port System (WPS) and Consolidated Aerial Port System to monitor the movement of forces and cargo, as well as the movement of military and commercial airlift, sealift, and surface assets.
- Establishing and conducting rail operations and Army terminal operations at SPODs and APODs, to include forming arrival/departure airfield control groups (A/DACG).
- Establish and manage Joint Logistics Over-the-Shore (JLOTS) operations.
- Air terminal operations include movement control, cargo transfer, unit and cargo marshaling, cargo documentation, and port clearance.
- Establishing and operating initial Army force provider facilities and arranging for required commercial or HNS-operated theater staging bases.
- Providing equipment deprocessing and property transfers for prepositioned unit equipment.
- Establishing areas for staging of Army Prepositioned Stocks (APS) materiel, transitioning personnel, and supplies.
- Establishing and operating in-theater force and materiel tracking information management systems.
- Validating air, sea, rail, and highway deployment rates for the force.
- Establishing movement management activities and conducting movement control operations.
- Coordinating port clearance and inland theater movement of forces and materiel.

## TRANSPORTATION THEATER OPENING ELEMENT (TTOE)

2-11. The TTOE (see Figure 2-3) is assigned to a TSC and attached to a sustainment brigade (TO). The element provides command, control, administration, logistics, and supervision of the operating elements of the unit in the performance of mission tasks. The TTOE provides staff augmentation to the sustainment brigade (TO). It augments a sustainment brigade support operations section by giving it the capabilities required to provide staff oversight of select TO operations. This includes establishing the initial distribution network and providing support to assigned customers; conducting minimum essential early-entry operations prior to employment of full theater opening capabilities; and C2 of employed units. Once expansion of the theater is largely complete or as conditions warrant, the TTOE will likely move to augment the ESC/TSC to manage the theater-wide movements and transportation mission. When the TTOE is resident with the sustainment brigade and the ESC/TSC has not yet arrived, the TTOE will have the mission to coordinate with all organizations conducting distribution functions impacting the JOA theater opening operations, regardless of whether the function occurs at the strategic, operational, or tactical levels. The TTOE will remain with the sustainment brigade, providing theater-level transportation staff augmentation, when the sustainment brigade is the senior sustainment HQ in the JOA.

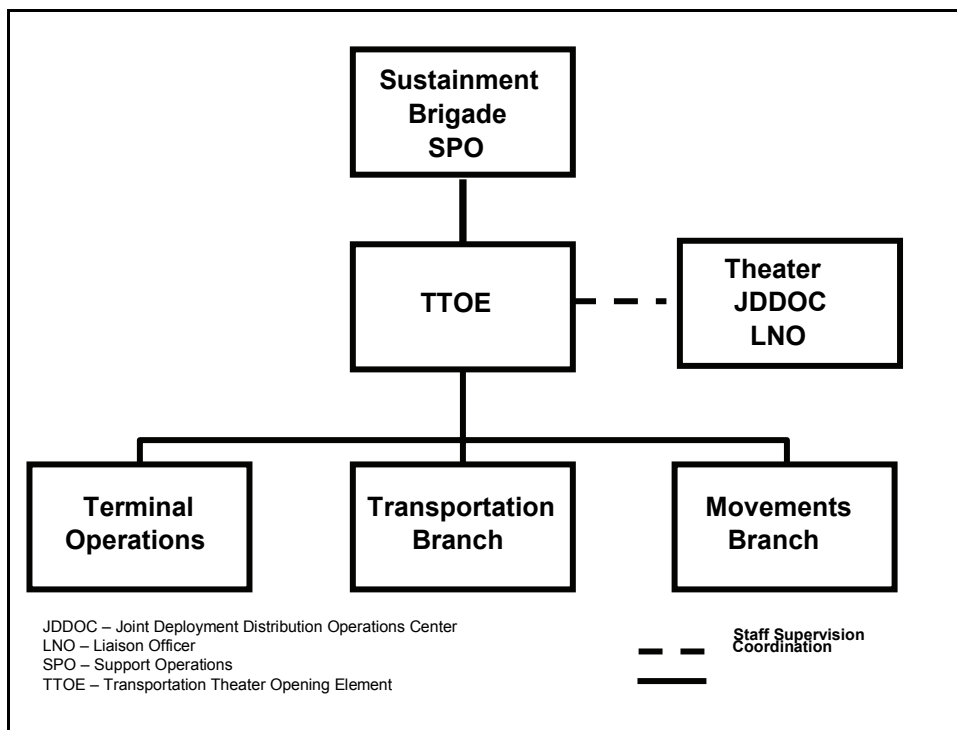

**Figure 2-3. Transportation Theater Opening Element (TTOE)**

2-12. The TTOE, which by design integrates into the brigade SPO section, includes the following:

- **Terminal Operations Branch** - Advises on the use and implementation of assigned, attached, contracted, and HN terminal and water craft operations; provides terminal infrastructure assessment; monitors and coordinates operation and positioning of terminal operations, including motor, rail, inter-modal, air, and sea; monitors and maintains status of terminal assets to ensure proper employment and appropriate tasking; and provides advice and expertise to the plans division in matters concerning terminal operations.
- **Transportation Branch** – Advises on the use and implementation of assigned, attached, contracted, and HN motor transport assets; provides guidance on positioning of motor transport, air, and rail assets; monitors and maintains the status of all modal transportation assets in the AO



and ensures proper tasking; and provides advice and expertise to the plans division in matters concerning mode transportation operations.

- **Movements Branch** – Implements and monitors movements programs and commits transportation assets in support of RSOI operations; maintains operational status; provides information and guidance on transportation operations to subordinate groups and battalions; maintains ITV; conducts transportation planning; plans support for contingency operations; and conducts exceptional movement requirements; coordinates the evacuation of civilian refugees and US civilians with proper authority; provides the senior sustainment HQ the required personnel to conduct theater-level (Executive Agent) movement control/management.

2-13. When circumstances warrant, the SB (SO)(A) may be tasked to oversee early entry theater opening in an operation expanding from SOF to conventional forces. When assigned this mission, the SB(SO)(A) is usually OPCON to the TSC. When assigned tailored CSSBs and functional sustainment companies, the SB (SO)(A) can—

- Receive forces and provide C2 of theater opening, theater distribution, signal, financial management, personnel, ammunition, transportation, maintenance, supply and services, human resources, and religious and other logistics elements.
- Support Army special operations task force early entry operations under C2 of the TSC until relieved by a conventional sustainment brigade HQ.
- Establish and manage initial theater-opening operations, to include RSO functions and the establishment of the theater base.
- Establish and manage initial theater distribution operations.

## THEATER DISTRIBUTION MISSION

2-14. Theater distribution (TD) is a decisive element of multifunctional support operations that include the following:

- Air, land, and sea operations.
- Management of materiel.
- Management of assets.
- Developing requirements and priorities.
- Synchronization with the capability to perform retrograde functions critical to the repair of vehicles, equipment, weapons and components.

Critical tasks include the following:

- Synchronizing multi-nodal, multi-modal distribution operations across an asymmetric operational environment in support of JFC requirements.
- Maintaining visibility of the distribution system.
- Performing distribution management.

The sustainment brigade performing TD operations will coordinate with the JDDOC, the ESC/TSC DMC, MCB/movement control teams (MCT), the J-4 of the Joint Force Land Component Commander, and the logistics staffs or SPO's of supported organizations. The theater JDDOC supports theater distribution by ensuring end to end visibility, managing strategic transportation assets, and synchronizing priorities.

2-15. The sustainment brigade (TD) is assigned and operates the ground transportation assets and manages selected aerial resupply assets, as well as the theater ground distribution network (nodes, rest halts, and distribution hubs) from the theater base distribution hub to other sustainment brigades, the BSBs, or to Centralized Receiving and Shipping Points (CRSPs). It is designed to provide C2 to assigned and attached units for the purpose of conducting distribution operations in the AO. Distribution operations include: receive, store, issue, distribute, trans-load, configure, reconfigure, classify, and collect stocks and unit equipment. It also includes the reception and transportation of units and replacement personnel.

2-16. When task organized to provide theater distribution the sustainment brigade may have capabilities which include:

- Configuring/reconfiguring loads as required. Distributing to and retrograding from BCTs, other brigades, and other forces operating in the AO (if directed).
- Storing bulk supplies and authorized stockage list (ASL) items for distribution and internal consumption.
- Managing and integrating surface distribution, ILAR assets (for example Air Land, Airdrop, Helicopter Sling Load), and rail operations.
- As directed by the TSC, providing the distribution of all supplies and services for which the sustainment brigade is responsible.
- Planning and controlling the use of surface transport for missions within assigned AO.
- Organizing the movements of subordinate units within its AO, which requires coordination with the supported maneuver elements concerning current and proposed locations and movement of units.
- Providing guidance and assistance to units in the AO on matters relating to airdrop.
- Providing staff supervision of technical training for personnel regarding the rigging and loading of supplies and equipment for airdrop and aerial resupply.
- In coordination with the TSC, integrating joint and commercial distribution capabilities.
- Delivering supplies, materiel, equipment, and personnel over the theater ground distribution network from the theater base to BCTs and forward distribution points as required.
- Maintaining surveillance over the theater ground distribution network.
- Operating forward distribution points to receive, store, issue, configure, and reconfigure materiel.
- Conducting retrograde, redirection, frustrated cargo, and redistribution operations.
- Establishing/maintaining total asset visibility/in-transit visibility TAV/ITV over commodities, equipment, personnel, units, and ground assets flowing in the distribution network to include what is inbound from the strategic base.
- Integrating the battlefield distribution information network.
- Executing the TSC's theater distribution plan.
- Operating regional distribution hubs, to include CRSPs.
- Synchronizing movements with the MEB through secured mobility corridors.
- Leveraging the available distribution infrastructure and optimizing pipeline flow to meet requirements and priorities.
- Projecting distribution pipeline volume, flow rates, contents, and associated node and port requirements. Adjusting pipeline flow and responding to changing operational requirements.
- Monitoring RSOI in order to integrate and prioritize unit moves and sustainment moves.
- Monitoring distribution terminal operations and the flow of multi-consignee shipments.
- Synchronizing reception of Army resources with theater movement control operations.
- Providing advice and recommended changes to the distribution system to the TSC commander, JFC distribution managers, or HN/contracted providers.
- Maintaining visibility of the physical, resource, communications, and automation networks within the assigned AO.
- Identifying capacity problem areas and actions to take within the distribution system.
- Managing and controlling the distribution pipeline flow through anticipatory support and the synchronization of materiel management and movement control.
- Distribution planning.
- Establish Convoy Support Centers (CSC) at the direction of the TSC.

## SUSTAINMENT MISSION

2-17. Sustainment is the provision of the logistics, personnel services, and health service support necessary to maintain operations until mission accomplishment (see FM 3-0). The endurance of Army forces is primarily a function of their sustainment. Sustainment determines the depth to which Army forces can conduct decisive operations, allowing the commander to seize, retain, and exploit the initiative. Endurance is the ability to employ combat power anywhere for protracted periods. Endurance stems from the ability to generate, protect, and sustain a force. It involves anticipating requirements and making the most effective, efficient use of available resources. Sustainment also enables strategic and operational reach. Army forces require strategic and operational reach to deploy and immediately conduct operations anywhere with little or no advanced notice (see FM 3-0).

2-18. The sustainment warfighting function consists of three subfunctions: logistics, personnel services, and health service support. Chapter 4 will provide a detailed discussion of the sustainment warfighting function. These three subfunctions are further broken down as follows:

- Logistics Subfunction—
  - Maintenance.
  - Transportation.
  - Supply.
  - Field services.
  - Distribution.
  - Contracting.
  - General engineer support.
- Personnel Services Subfunction—
  - Human resources support.
  - Financial management.
  - Legal support.
  - Religious support.
  - Band support.
- Health Service Support Subfunction—
  - Organic and area medical support.
  - Hospitalization.
  - Treatment aspects of dental care.
  - Behavioral health and neuropsychiatric treatment.
  - Clinical laboratory services and treatment of chemical, biological, radiological, and nuclear patients.
  - Medical evacuation.
  - Medical logistics.

2-19. The sustainment brigade performs sustainment operations from the operational to tactical levels. Operational sustainment focuses on theater operations that involve force deployment/reception, movement distribution, sustainment, and reconstitution. The initial focus is on generating a force ready to conduct operations. Support begins during force generation but becomes the primary focus once operations begin. Key Army functions associated with operational level sustainment include the following:

- Coordinating supply of arms, munitions, and equipment.
- Synchronizing supply and distribution of fuel and water.
- Ensuring effective cross-leveling of supplies and efficient retrograde and redeployment of equipment, personnel, and supplies.
- Maintaining equipment and stocks that support the supply system.
- Coordinating support of forces, to include: personnel, human resources, supply, equipment, field services, health, religious support, financial management, and legal services.
- Managing materiel, controlling movement, and managing distribution.

- Providing lead service CUL to other services, multinational partners, and civilian agencies on order.
- Establishing, managing, and maintaining facilities, including storage areas and maintenance areas.
- Providing direct support field maintenance to units in its assigned AO.
- Planning, coordinating, managing, and supervising the positioning and security of sustainment activities.
  - Coordinate through CSB for contingency contracting.
  - Maintaining visibility of customer locations.
  - Maintaining information regarding support relationships.

2-20. The sustainment brigades are assigned multifunctional battalions and functional battalions and companies tailored and task organized to the specific mission. The sustainment brigade will normally have multiple CSSBs assigned to provide distribution and supplies to BCTs and supporting brigades operating within its assigned AO and other forces operating in or transiting its AO.

2-21. These supported brigades may be in one division or multiple divisions. The sustainment brigade (or logistics task force in a joint environment) establishes a base(s) within the AO to conduct operations. The MEB may be responsible for the terrain assignment and establishing secure movement corridors. The sustainment brigade base will be integrated into area terrain management and protection plans based on established C2 relationships and the physical space occupied.

2-22. Key elements of the Army support structure at the operational level include APS, dedicated transportation, general support supply, sustainment maintenance, and human resources elements. Many of the stocks to support the AO are stored by Army logistics units, allowing tactical-level logistics units to remain mobile. Support at the operational level includes CUL support to joint and multinational forces, as required. Many different sources contribute to these support functions, including contractors, DA and DOD civilians, US Army and joint services, and multinational military organizations, and host nation resources.

2-23. Sustainment at the tactical level encompasses those activities that maintain and supply forces. The two ways that sustainment brigades provide support for a deployed Army force at this level are:

- The organic support battalions and Forward Support Companies (FSCs) of the BCTs and other brigades.
- Replenishment furnished to EAB organizations on an area basis.

### **Replenishment Operations**

2-24. Replenishment operations (ROs) are preplanned operations that allow combat forces to replenish routinely. An RO is a deliberate, time sensitive operation to replace used stocks within a BCT or support brigade (see Figure 2-4). These operations which may be, but are not normally, augmented with assets from the sustainment brigade, are quick and in-stride with the supported commander's battle rhythm. The purpose of the RO is to replace stocks used by a brigade. It may be either deliberate or hasty if circumstances allow. Typical activities that take place during the RO include rearming, refueling, maintaining, medical support, and essential personnel replacement to meet immediate needs. The BSB conducts RO to its FSCs and the FSCs also conduct RO to the combat loads of individual Soldiers and weapons platforms. The BSB will need to coordinate the timing of the RO with the sustainment brigade to ensure that the delivery from the sustainment brigade supports both the required stockade levels and the timing of its RO.

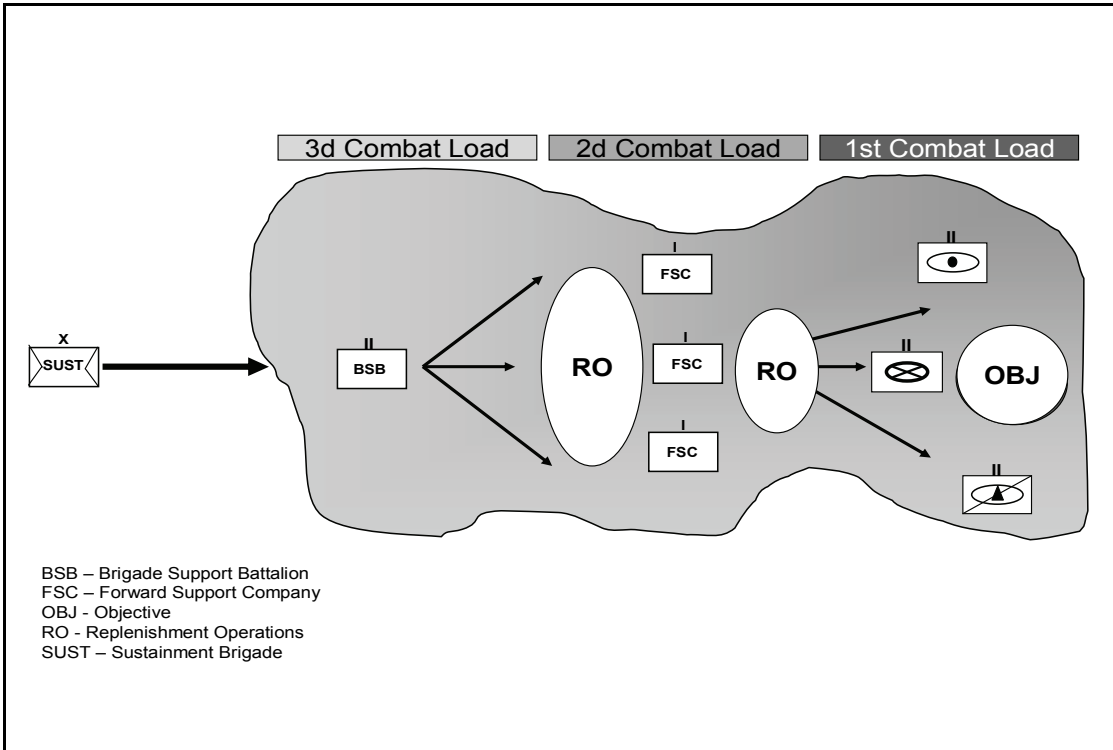
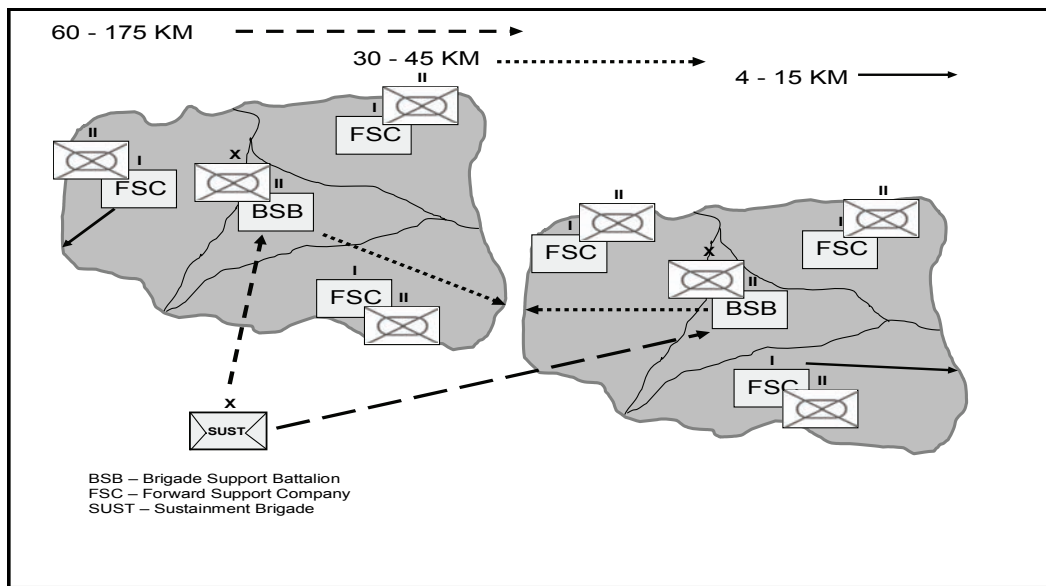

Figure 2-4. Replenishment Operations

**OPERATIONAL DISTANCES**

2-25. As a general guideline, in order to prevent overreach of units in tactical environments, the recommended distance between a Sustainment Brigade and the BSBs it supports should be from 60 to no more than 175 KM (see Figure 2-5). The 175 KM limit reflects one line haul trip a day (max 222 KM-20% = 177 KM), and is constrained by fuel consumption of the distribution platform(s). The lower distance of 60 KM reflects line haul in rough terrain (6 hr x 10 KM/hr). For both, the assumption is that the longest time a driver can continuously and safely drive in a shift is 6 hours (one way trip). There is also an assumption of two drivers per vehicle. Ideally, the BSBs should be from 30 KM to 45 KM from combat operations and the FSCs should be from 4 KM to 15 KM from combat.



**Figure 2-5. Operational Distances**

2-26. The following considerations should be used in determining operational distances:

- Sustainment Brigade's will locate near major transportation nodes (airfields, rail heads, inland, water ports).
- There are no CSCs inside a division's assigned area of operation.
- Line haul convoys will not normally be refueled by BSBs.
- Distances are constrained by the vehicle with the heaviest fuel consumption.
- Distribution platforms should return with a 20 percent capacity fuel safety margin.
- The longest time a driver can continuously and safely drive in a shift is 6 hours.
- Critical items are distributed via throughput (normally by air).
- Sustainment Brigade's schedule of line haul replenishments to BSBs.
- Poor roads reduce travel time by half from that of good roads.
- Night driving reduces travel time by half from day driving.

## ARMY UNIVERSAL TASK LIST (AUTL) TASKS

2-27. The AUTL contains guidance for developing the sustainment brigade mission essential task list (METL). The sustainment brigade develops its battle-focused METL as described in FM 7-0 based on guidance from the ASCC and TSC. Sustainment brigade METL developers consider those specific AUTL tasks that support the Army's lead service responsibilities (Chairman of the Joint Chiefs of Staff manual 3500.04C). These tasks are either stated or implied in the ASCC and GCC war plans.

2-28. The sustainment brigade performs AUTL tasks when the division is the ARFOR HQ supported by the sustainment brigade directly. Some tactical-level tasks covered in the Army Universal Task List (FM 7-15), may also apply because the sustainment brigade's subordinate units will perform operational to tactical-level support tasks and conduct convoys which are combat operations. The TSC commander approves the sustainment brigade METL.

## SECTION II – STAFF ROLES AND FUNCTIONS

2-29. The sustainment brigade comprises a brigade HQ (commander and staff) for controlling and assessing operations and a special troops battalion (STB) to provide support to personnel assigned to the sustainment brigade and the STB. All other mission capabilities are supplied by elements task organized to the sustainment brigade. The sustainment brigade is tailorable and can provide effective support for multiple brigade-sized organizations. The size and capabilities of the sustainment brigade are determined by METT-TC considerations.

2-30. The sustainment brigade HQ coordinates, synchronizes, monitors, and controls sustainment operations within its assigned AO, through subordinate tailored sustainment units. It can be augmented from the TSC to manage joint logistics operations and can provide CUL in support of joint forces. As mentioned before, the brigade may conduct a wide-range of operations, depending on its organization and mission requirements. It will typically establish a base within its AO to provide centralized control of operations. Decentralized execution of operations may be conducted within the base or at designated locations within its support area.

2-31. The sustainment brigade has the ability to deploy an Early Entry Element (EEE). The EEE provides the sustainment brigade commander the capability to forward deploy limited brigade capabilities. The EEE provides C2 of sustainment operations during initial operations and while establishing the theater base. Sustainment brigades tasked to conduct theater distribution or sustainment, use their EEEs to establish an initial C2 presence in a theater of operations and to provide for continuous C2 when the brigade incrementally repositions its forces in support of on-going or anticipated mission requirements. The EEE is formed from organic sustainment brigade and STB elements as directed by the commander. The EEE provides limited capabilities to C2 the sustainment brigade mission within the assigned AO prior to the full deployment of the brigade.

### THE COMMAND GROUP

2-32. The command group, depicted in Figure 2-6, consists of the brigade commander, the deputy commander, the coordinating staff officers (S-1, S-2, S-3, S-4, S-6, SPO), and certain special and personal staff officers (command sergeant major, staff judge advocate, surgeon, and chaplain). It provides C2 of assigned and attached units and directs sustainment brigade operations and integrates the functions of the coordinating staff. The following staff specific paragraphs discuss each staff element's responsibilities in broad terms.

2-33. The deputy commanding officer (DCO) is the commander's principal staff officer, directing and overseeing staff coordination and ensuring effective and prompt staff actions. The DCO also oversees coordinating and special staff officers. The commander normally delegates authority to the DCO for executive management of coordinating and special staff officers. The DCO also serves as EEE commander when tasked.

2-34. The commander, DCO, and the command sergeant major each have a Force XXI Battle Command, Brigade and Below (FBCB2) in order to support situational awareness of force locations.

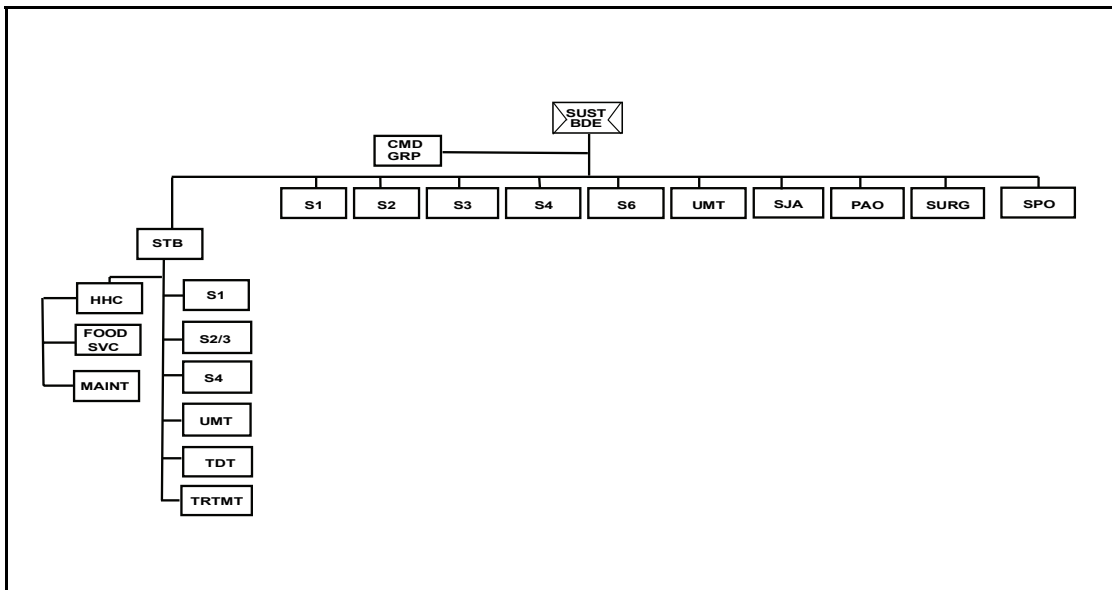

**Figure 2-6. Sustainment Brigade Staff Organization**

## THE COORDINATING STAFF

2-35. These staff sections perform common staff responsibilities that are briefly described below with more detail provided in FM 6-0. They develop internal sustainment brigade policies and plans in their respective technical areas and provide guidance, priorities, and allocations to subordinate commands. They also review the plans of counterpart staffs in subordinate units.

### S-1 SECTION

2-36. The S-1 section is principally responsible for the delivery of human resources (HR) support to all assigned and attached personnel in the Sustainment Brigade, to include subordinate organizations. HR support includes personnel readiness management, personnel accountability, strength reporting, R5 operations, casualty operations, essential personnel services, postal operations, morale, welfare, and recreation (MWR) operations, and HR planning and operations. Essential personnel services include military pay, awards and decorations, evaluations, ID documents, promotions, and personnel actions. The S-1 is directly linked with the Human Resources Command for strength management, replacement operations, personnel accounting, and strength reporting. The S-1 section receives technical guidance from the TSC or ESC G-1 and the HR Operations Cell. The S-1 provides technical guidance to all subordinate battalion S-1. Automation support is provided by FBCB2, Battle Command Sustainment Support System (BCS3), and when implemented, the Defense Integrated Military Human Resources System (DIMHRS). See FM 1-0 (Human Resources Support) and FMI 1-0.01 (S-1 Operations) for additional information.

### S-2 SECTION

2-37. The S-2 is the principal staff officer to the commander in matters concerning security and intelligence. Primary tasks include: intelligence readiness, the Commander's priority intelligence requirements, collection plan, indications and warnings, and MDMP. By using information systems and technology, the S2 identifies threat composition, strength, capabilities, and courses of action; conducts intelligence and logistics preparation of the battlefield; and provides terrain and weather analysis with an emphasis on lines of communication. The S2 also contributes to the All Source Analysis System (ASAS) and disseminate relevant intelligence from ASAS into current operations and future plans. The S2 prepares Annex B of the operations order; monitors the intelligence requirements to support current and future operations; monitors intelligence analysis of higher, lower, adjacent, and subordinate units; coordinates



with other intelligence agencies to effectively provide predictive and timely intelligence to support logistic missions. The S2 utilizes the most effective and secure means to track and disseminate threat information and provide intelligence products.

### **S-3 SECTION**

2-38. The S-3 is the principal staff officer for the commander in matters concerning operations, plans, protection, organization, and training. Primary tasks include training, operations, plans, force development, and modernization. Using Maneuver Control System (MCS), the S-3 performs the following:

- Prepares and issues warning and fragmentary orders (FRAGOs) to support the current operations.
- Monitors the operations of higher, lower, and adjacent units.
- Monitors operations.
- Coordinates with supported units to synchronize future operations and the transition from the current operation to a future operation without loss of momentum and unit integrity.
- Manages the terrain.
- Plans for, utilizes, and optimizes automation for mission planning, course of action development, rehearsals, operational planning, and after action reviews.

The S-3 uses Movement Tracking System (MTS) to track convoy operations.

### **S-4 SECTION**

2-39. The S-4 is the principal staff officer for the commander in matters concerning internal sustainment and readiness. Primary tasks include: sustainment operations and plans, supply, maintenance, transportation, and field services. The S-4 advises the commander and staff on all internal logistics issues; coordinates estimates, plans, annexes, and orders for internal sustainment operations; tracks the current operation, provides staff oversight of food service operations, property book operations, and maintenance operations for the sustainment brigade and its subordinates. The S-4 is normally tasked to oversee the deployment of the sustainment brigade and its subordinate units.

2-40. The property book office (PBO) supervises all input and output from the automated process supporting the property book system and Class VII. The office manages Class VII items stocked within the brigade itself. It coordinates supply transaction documents and verifies records and processes data for entry into the property book system. The PBO receives records and verifies data entered on supply transaction documents for supported units. It processes unit requests for issue and turn-in of organizational property using Property Book Unit Supply Enhanced (PBUSE). The teams process financial liability investigations of property loss, statements of charges, and other accountability documents.

### **S-6 SECTION**

2-41. The S-6 major tasks involve Network Operations (NETOPS) and information management. The S-6 provides technical staff supervision over signal support activities throughout the sustainment brigade. The S-6 provides technical supervision of all communications asset attachments, coordinates with the supporting signal unit to maintain access to higher echelons common user signal networks, develops and coordinates signal support plans, and ensures redundant signal means are available to maintain the network. More detailed information about the S-6 section's role and responsibilities can be found in Chapter 3.

## **SUPPORT OPERATIONS (SPO) SECTION**

2-42. The SPO is the principal staff officer for coordinating support for all units within the sustainment brigade's assigned AO. The SPO also provides technical supervision of all sustainment operations conducted by the sustainment brigade and is therefore the key interface between supported units and the TSC/ESC. The SPO provides planning, preparation, and C2 of the execution of all sustainment operations

in the sustainment brigade’s AO, to include theater opening, distribution, and sustainment operations. The SPO section provides centralized coordination of all actions supporting subordinate units and all non-brigade forward support units. The support operations staff is depicted in Figure 2-7. A brief description of each staff element follows.

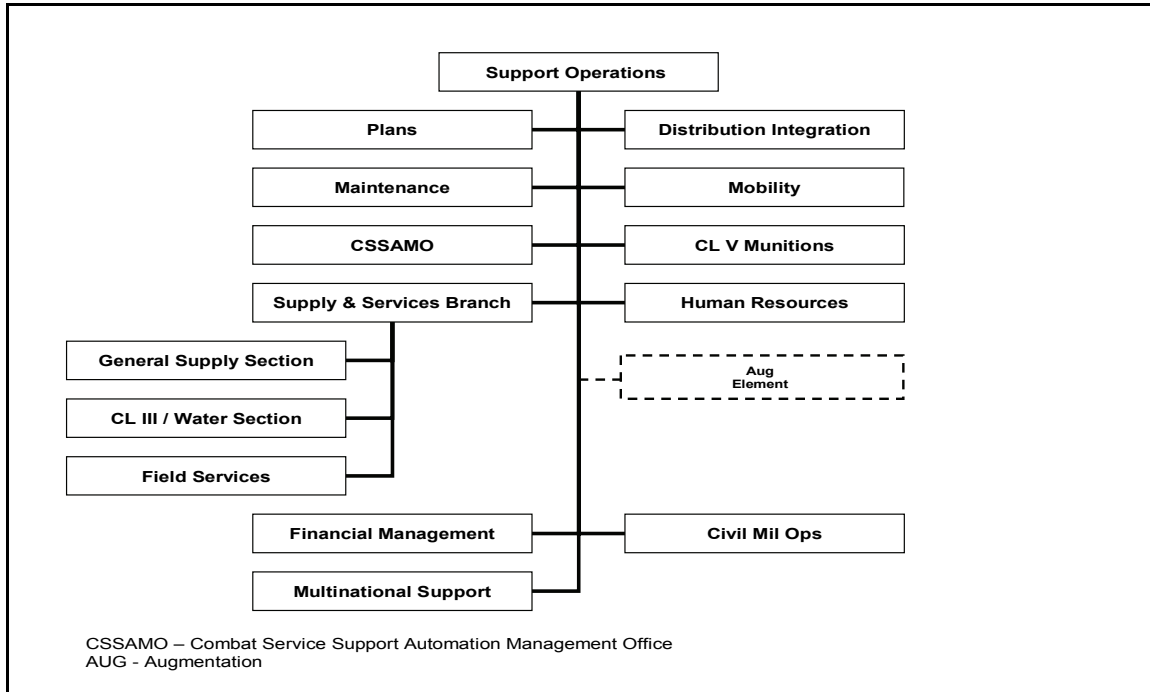

Figure 2-7. Sustainment Brigade SPO

**PLANS BRANCH**

2-43. The plans branch develops the concept of support and support plans for future operations in concert with the sustainment brigade S-3 and the G-3 of the supported units. This office also coordinates with the G-3 of supported units. The branch recommends/incorporates all technologies/automation, combat unit requirements, unit historical data, current/future replenishment posture, mobility data, and commander’s guidance into the development of the support plan. The branch in conjunction with the brigade S-3 develops the operations order and associated logistics annexes to all plans and orders using BCS3. It maintains the running estimate, and utilizes interoperable automation and communications to perform the daily management functions and fusion of all requirements for all elements within the SPO associated with tasking control for external support operations.

**DISTRIBUTION INTEGRATION BRANCH**

2-44. The Distribution Integration Branch coordinates and synchronizes the movement of all personnel, equipment, and supplies in the assigned area. It provides capacity visibility and ensures an uninterrupted flow of support. The focus of this branch is to plan and monitor the execution of distribution operations; to collect, collate, and analyze support information for the SPO, and to be the fusion center for brigade distribution-related information, using BCS3, Transportation Coordinator’s Automated Information for Movement System (TC AIMS), and MTS. It synchronizes operations within the distribution system to maximize throughput and follow-on sustainment and executes the priorities recommended by the Mobility Branch. It maintains automated transportation movement control, tracking and request system. In addition to accomplishing their specific commodity/management missions, all other branches will channel information to this branch to improve the total distribution system visibility and to allow for overall

coordination, prioritization, and decision-making by the SPO. It compiles the distribution plan from the input described above and publishes the distribution/push matrix for tasking of distribution assets. To do this job effectively, the Distribution Integration Branch relies on coordination and information exchange, in particular between the Supply, Human Resources, and the Mobility Branches. If requirements are beyond the capability/capacity of the sustainment brigade's subordinate units, then this branch notifies the TSC with the concurrence of the SPO and S-3.

### **MAINTENANCE BRANCH**

2-45. The maintenance branch manages maintenance for the supported units and provides staff oversight of subordinate unit readiness, using Standard Army Maintenance System – Enhanced (SAMS-E). This office plans and forecasts maintenance and related materiel requirements based on future operational plans and it coordinates the disposal of enemy equipment. It prepares all maintenance plans and annexes for support plans and orders and provides status reports. This office also is responsible for managing maintenance production for electronic systems for the brigade and for managing maintenance production for test, measurement, and diagnostic equipment for the brigade.

### **MOBILITY BRANCH**

2-46. The Mobility Branch collects, validates, and manages requirements for air and surface movements from supported units, determines the most appropriate mode for the requirements, and recommends priorities of movement for each separate mode. The requirements and recommendations are passed to the Distribution Integration Branch for action. The Mobility Branch provides staff oversight of all allocated transportation assets and coordinates directly with the MCT using MTS. The branch exercises staff oversight over transportation operations for the sustainment brigade. Mission planning for deployment, movement, sustainment, reconstitution, and redeployment is performed by the branch in conjunction with the distribution integration branch using TCAIMS. It provides movement management for personnel and materiel (except bulk POL by pipeline) in the assigned area. It provides guidance, advice, and staff oversight on the employment and capabilities of air, land, and water transportation for subordinate units, to include hub operations.

### **COMBAT SERVICE SUPPORT AUTOMATION MANAGEMENT OFFICE (CSSAMO)**

2-47. The CSSAMO installs and monitors the combat service support automated information system interface (CAISI) and Very Small Aperture Terminals (VSAT) network and satellite operations to provide assured, unclassified but sensitive, non-secured communications and provides user customer support in sustaining and operating the STAMIS used in the sustainment brigade and supported battalions (especially those functional battalions that do not have an organic CSSAMO); this includes all installation, testing, loading, and troubleshooting of STAMIS software, limited hardware, user owned communications devices, and monitoring user training programs and new equipment fielding. The CSSAMO also establishes the unclassified wireless network, domain-name service and monitors network traffic and protection status. It provides software maintenance support to organic sustainment brigade elements. The CSSAMO may also provide support to subordinate battalions, functional brigades, and other units in the supported AO, and might, if required, provide temporary support to BCT and support brigades as directed.

### **CLASS V MUNITIONS BRANCH**

2-48. The Class V Munitions Branch coordinates and supervises supply management of all ammunition operations for the AO using Standard Army Ammunition System - Materiel Management Center (SAAS-MMC). The branch maintains asset visibility of all munitions, maintains the munitions portion of the COP through TAV/ITV, and conducts munitions reach operations for supported units. The Class V branch will intensively monitor and manage critical munitions and Controlled Supply Rates established by the TSC.

## **SUPPLY AND SERVICES (S&S) BRANCH**

2-49. The S&S branch coordinates and supervises supply management for water, Class I, II, III, IV, VII, and IX supplies for the AO. This branch plans and determines the requirements and recommends priorities for the allocation and distribution control of supplies. It conducts automated requisition of commodities and makes recommendations on redistribution within the AO. It maintains visibility of on-hand and in-bound supply stockage using BCS3, recommends ASL mobility requirements, and develops basic load recommendations. This branch also provides advice on the receipt, storage, and distribution of supplies within its AO.

### **General Supply Section**

2-50. The general supply section controls and manages Class I, II, III (P), IV and IX supplies to the supported elements. It directs the receipt, storage, and distribution of Class I, II, III (P), IV and IX supplies within the AO. This section uses PBUSE and corps/theater automated data processing service center (CTASC) flyaway automation.

### **Class III-Water Section**

2-51. The Class III-water section controls and manages the bulk fuel and water supply to the supported elements. It directs the receipt, storage, inspection, testing, issue, distribution, and accountability of the bulk fuel and water stocks for the AO. There is no automation that supports water or Class III supply operations.

### **Field Services Section**

2-52. The field services section coordinates for field services for supported forces. Field services involve light textile repair, laundry, shower, mortuary affairs (MA), and aerial delivery support. During combat operations, military personnel provide most of the field service support in forward areas, with support from HNS and contractors.

## **HUMAN RESOURCES (HR) BRANCH**

2-53. The HR branch is responsible for planning, coordinating, integrating, and synchronizing the activities of subordinate units (HR companies, platoons, and teams) for the SPO in the sustainment brigade area of the theater of operations. This includes ensuring they are resourced, correctly positioned, and properly allocated to provide required postal, R5, and casualty support (see FM 1-0, Human Resources Support and FMI 1-0.02, Theater Level HR Support). Critical functions are:

- Serve as integrator between Human Resource Sustainment Center (HRSC), supported units (G-1/S-1) and HR Companies, Military Mail Terminal Team, and Theater R5 Gateway Team.
- Synchronize HR support for postal, casualty, and R5 operations with other sustainment elements and organizations.
- Plan, project, and recommend HR support requirements for current and future military operations. Includes assessing the current situation, forecasting HR requirements based on the progress of the operation, making execution and adjustment decisions, and directing actions to apply HR resources and support at decisive points and time.
- Provide technical guidance to supported units (G-1/S-1) and supporting HR organizations (HR Co, MMT, R5 Gateway). The HR branch receives technical guidance from the HR branch of the ESC SPO and the HRSC of the TSC.
- Deploy as part of the sustainment brigade or ESC early entry element to assist/ensure initial theater R5 Personnel Processing Center (PPC) and postal operations are established.
- Coordinate and provide technical training to supported and supporting units.

- Coordinate the execution of non-HR sustainment tasks (billeting, feeding, and transportation) with other sustainment elements.

### **FINANCIAL MANAGEMENT (FM) BRANCH**

2-54. The FM branch monitors and tracks FM operations throughout the sustainment brigade AO. It integrates all FM operations, assists in planning the employment of FM units, coordinates requirements, synchronizes the FM network, and manages the FM systems in coordination with the financial management center (FMC) and G-8. This includes ensuring FM companies and subordinate detachments are resourced, correctly positioned, and properly allocated to provide required financial management support (see FM 1-06, Financial Management). Critical functions are:

- Serves as integrator between the financial management center (FMC), supported units, ESC SPO, FM companies, and detachments.
- Synchronizes FM support with other sustainment elements and supported organizations for commercial vendor services, paying agent services, Soldier disbursing services, stored value card program, and other financial management services.
- Plans and recommends FM support requirements for current and future military operations, including assessing the current situation, and forecasting FM requirements, to include cash holding authority.
- Provides technical guidance to supported units and supporting FM organizations (FM company and detachments).
- Receives operational guidance from the FM branch of the ESC SPO and technical guidance from the FMC of the TSC.
- Deploys as part of the sustainment brigade or ESC early entry element to assist/ensure initial FM capabilities are established to support initial entry and set conditions for subsequent follow-on operations.
- Coordinates and provides technical training to supported and supporting units to include operational reviews of companies and detachments conducted by the internal control branch of the FMC.

### **CIVIL AFFAIRS SECTION**

2-55. The Civil Affairs Section is the principal advisor to the commander in matters regarding civil affairs. Primary tasks include: establish the civil-military operations center; evaluate civil considerations during mission analysis and prepare for transitioning the AO from military to civilian control. The civil affairs is also responsible for the following:

- Advising and counseling the commander and staff on CMO.
- Developing civil affairs annexes, plans, and guidance.
- Responding to DA, DOD, and NGO queries.
- Reviewing plans for civil affairs implications in stability and reconstruction operations.
- Coordinating with the SPO concerning civil affairs assets and operations in support of stability and reconstruction operations.
- Providing staff assistance to the SPO/contracting elements to locate, coordinate, and develop local sourcing for service and support.

### **MULTINATIONAL SUPPORT BRANCH**

2-56. The Multinational Support Branch manages requirements for multinational units supported by the sustainment brigade. It also provides the base to which liaison officers are assigned from multinational units which are either being supported by the brigade or which are not being supported but are conducting operations in conjunction with the brigade.

## SPECIAL AND PERSONAL STAFF

2-57. Special staff officers help the commander and other staff members perform their functional responsibilities. Special staff officers usually deal routinely with more than one coordinating staff officer. For example, the STB commander routinely deals with the brigade S-3, but coordinates with the S-1, S-2, SPO, S-4, and others.

2-58. Personal staff members work under the commander's immediate control. They also may serve as special staff officers when they coordinate with other staff members. When performing their duties as special staff officers, personal staff officers may work through the DCO and under a coordinating staff officer for coordination and control purposes.

## COMMAND SERGEANT MAJOR

2-59. The command sergeant major (CSM) is a member of the commander's personal staff by virtue of being the command's senior noncommissioned officer (NCO). The CSM is responsible for providing the commander with personal, professional, and technical advice on enlisted Soldier matters and the NCO corps. The CSM's duties and responsibilities vary according to the commander's specific desires or needs; however, general duties are:

- Provide advice and recommendations to the commander and staff in matters pertaining to enlisted personnel.
- Help formulate and supervise enforcement of established policies and standards concerning enlisted personnel performance, training, appearance, and conduct.
- Maintain communication with subordinate NCOs and other enlisted personnel through NCO channels.
- Monitor unit and enlisted personnel training and make corrections as necessary.
- Administer and monitor the unit NCO development program and sergeant's time training.
- Provide counsel and guidance to NCOs and other enlisted personnel.
- Administer and chair unit selection and Soldier boards for enlisted personnel.
- Receive and orient newly assigned enlisted personnel.
- Help inspect command activities and facilities.
- Monitor and recommend actions to enhance the morale and discipline of the command.
- Assist the STB commander to coordinate unit security operations.

## SURGEON

2-60. The sustainment brigade surgeon ensures that all AHS support functions are considered and included in operation plans and operation orders. The sustainment brigade surgeon is a full-time special staff officer answering directly to the sustainment brigade commander on matters that pertain to the health of the command. He/She coordinates for AHS support for both Health Service Support (HSS) and force health protection (FHP). The sustainment brigade command surgeon coordinates AHS support operation with both the division surgeon and the medical brigade (MEDBDE) commander and helps establish medical guidelines for the division and the sustainment brigade. The duties and responsibilities of the sustainment brigade surgeon include both HSS and FHP functions.

### Health Service Support

- 2-61. The sustainment brigade surgeon's duties and responsibilities for AHS may include—
- Advising the commander on the health of the sustainment brigade units.
  - Plans and coordinating for HSS for sustainment brigade units (including but not limited to, medical treatment, medical logistics, medical evacuation, hospitalization, dental support, preventive medicine [PVNTMED], behavioral health, and clinical medical laboratory support).

- Developing and coordinating the HSS portion of AHS operation plans to support the sustainment commander's decisions, planning guidance, and intent in support of full spectrum operations (see FM 4-02.12 and FM 8-55).
- Determining the medical workload requirements (patient estimates).
- Advises the sustainment brigade commander on policy regarding the eligibility of care for non-US military personnel.
- Maintaining situational understanding by coordinating for current HSS information with surgeons of the next higher, adjacent, and subordinate HQ.
- Recommending task organization of medical units/elements in support to sustainment brigade units to satisfy all HSS mission requirements.
- Recommending policies concerning medical support of stability operations (that include civil-military operations).
- Monitoring troop strength of medical personnel and their utilization.
- Coordinating and synchronizing health consultation services.
- Evaluating and interpreting medical statistical data.
- Monitoring medical logistics and blood management operations in the theater (see FM 4-02.1).
- Monitoring medical regulating and patient tracking operations for sustainment brigade personnel (see FM 4-02.2).
- Determining sustainment brigade training requirements for first aid and for maintaining wellness of the command.
- Ensuring field medical records are maintained on each Soldier assigned to the TSC at their primary care medical treatment facility per AR 40-66 and FM 4-02.4.
- Establishing, in coordination with the chain of command, and promulgating a plan to ensure individual informed consent is established before administering investigational new drugs as described in Executive Order 13139.
- Recommending disposition instructions for captured enemy medical supplies and equipment. (Refer to FM 4-02 for additional information on the Geneva Conventions.)
- Submitting to higher HQ those recommendations on medical problems/conditions that require research and development.
- Coordinates and synchronizes:
  - Health education and combat lifesaver training for the brigade.
  - Mass casualty plan developed by the S-3.
  - Medical care of enemy prisoners of war (EPW), detainees, and civilians within the brigade AO.
  - Treatment of sick, injured, or wounded Soldiers.
  - Medical evacuation, including use of both the Army's dedicated medical evacuation (MEDEVAC) platforms (air and ground).
  - Medical logistics including Class VIII resupply, blood management, and medical maintenance.
  - Health-related reports and battlefield statistics.
  - Collection and analyses of operational data for on-the-spot adjustments in the medical support structure and for use in post operations combat and materiel development studies.
  - Army Health System support for stability and civil support operations

## Force Health Protection

- 2-62. The sustainment brigade surgeon's duties and responsibilities for FHP may include—
- Identifying potential medical-related commander's critical information requirements (priority intelligence requirements and friendly force information requirements) as they pertain to the health threat; ensuring they are incorporated into the command's intelligence requirements.
  - Coordinating for veterinary support for food safety, animal care, and veterinary preventive medicine to include zoonotic diseases transmissible to man.
  - Planning for and implementing FHP operations to counter health threats (see FM 4-02.17). Force health protection operations may include:
    - Planning for and accomplishing redeployment and post deployment health assessments. Establishing and executing a medical surveillance program (refer to AR 40-5, AR 40-66, and FM 4-02.17 for an in-depth discussion).
    - Establishing and executing an occupational and environmental health surveillance program (see FM 3-100.4).
    - Recommending combat and operational stress control, behavioral health, and substance abuse control programs (see FM 4-02.51).
    - Ensuring the general threat, health threat, and medical intelligence considerations are integrated into AHS support operation plans and orders.
    - Advising commanders on FHP chemical, biological, radiological, and nuclear (CBRN) defensive actions, such as immunizations, use of chemoprophylaxis, pretreatments, and barrier creams.
    - Identifying health threats and medical-related commander's critical information requirements.
  - Maintaining situational understanding by coordinating for current FHP information with surgeon staffs of the next higher, adjacent, and subordinate HQs.
  - Coordinates and synchronizes:
    - Combat and operational stress control program with the division surgeon section (DSS) and supporting medical brigade.
    - Veterinary food inspection, military working dogs and other animal care, and veterinary preventive medicine activities of the command, as required.
    - Preventive medicine services to include identification of health threats.
    - Preventive dentistry support program for the prevention of cavities and gum disease.
    - Area medical laboratory support to include the identification of biological and chemical warfare agents, as required.

## BRIGADE SURGEON SECTION

2-63. The sustainment brigade surgeon section (BSS) assists the sustainment brigade surgeon with the above responsibilities. The BSS monitors and tracks operations with medical communications for Medical Communications for Combat Casualty Care (MC4) System and provides updated information to the surgeon and the SPO chief for building capabilities to meet the sustainment brigade's medical requirements identified by the surgeon. Other functions include:

- Planning for the AHS support for the sustainment brigade's units.
- Identifying and coordinating through the DSS and as authorized directly with medical brigade elements to support requirements of the sustainment brigade.
- Coordinating/managing medical evacuation and treatment capabilities.
- Coordinating/managing Class VIII resupply capabilities.
- Ensuring medical support is integrated and synchronized with the sustainment brigade's operational support plan.



The BSS consist of two cells (a plans and operations cell and a medical logistics (MEDLOG) and sustainment cell). Also, under the technical control of the surgeon is the medical treatment team and evacuation squad.

### **Medical Plans and Operations Cell**

2-64. The medical plans and operations cell is normally staffed with medical operations officers (Major, 04, AOC 70H00), an medical operations NCO (E-7, military occupational specialty 68W40). The primary function of this cell is medical planning to ensure that adequate AHS support is available and to provide, in a timely and efficient manner, for the sustainment brigade and its attached units. This cell coordinates with the DSS and, as authorized, with medical brigade for the placement and support requirements of medical units and elements located in the sustainment brigade AO. See FM 8-55 and FMI 4-02.21 for additional information on medical staff planning.

### **Medical Logistics and Sustainment Cell**

2-65. The medical logistics and sustainment cell is normally staffed with a MEDLOG officer (Major, 04, AOC 70K00). This cell receives daily updates on the status of Class VIII within the brigade and from attached medical units/elements. The MEDLOG and sustainment cell coordinate shortfalls in throughput distribution with the supporting MEDLOG company or supply support activity (SSA). This cell may update priorities with the supporting MEDLOG activity to correct deficiencies in the delivery system. The supporting MEDLOG company or SSA will forward information to the MEDLOG and sustainment cell on items filled and shipped and on those requisitions that were not filled. This cell provides daily updates to the sustainment brigade surgeon and SPO chief on the status of Class VIII in the brigade. See FM 4-02.1 for definitive information on MEDLOG operations.

## **STAFF JUDGE ADVOCATE**

2-66. The staff judge advocate (SJA) is a member of the commander's personal staff. The SJA section consists of a staff judge advocate, operational law attorney, and paralegal NCO. Battalion paralegals serve at either the unit level or are consolidated at the brigade level. The SJA communicates directly with the commander to provide legal advice for all matters affecting law of land warfare, morale, good order, and discipline of the command. For other than disciplinary matters, the SJA serves under the supervision of the chief of staff and provides legal services to the staff, and coordinates with other staff members to provide responsive legal services throughout the organization.

2-67. The SJA, as a field representative of the judge advocate general, provides technical supervision over all judge advocate general's corps personnel and legal services in the command. This includes the following:

- Planning legal support.
- Requesting resources.
- Conducting and evaluating training.
- Assigning and professionally developing judge advocate general's corps personnel assigned to the command.

The SJA may also use the legal technical channel to communicate with the judge advocate general and other supervisory judge advocates.

2-68. The SJA is responsible for all legal support and services required by the command. The SJA's duties include:

- Participating, along with the commander and staff, in mission planning and the military decision making process.
- Preparing legal estimates, drafting legal annexes, and reviewing operational plans and orders.
- Interpreting status of forces agreements.
- Developing, interpreting, and training rules of engagement and rules on the use of force.

- Advising on the application of the law of war (and other humanitarian law) to military operations, including the legal aspects of targeting.
- Coordinating determinations on the status and proper treatment of EPW, detainees, and civilian noncombatants.
- Ensuring the proper reporting and investigations of violations of the law of war.
- Advising on legal aspects of civil-military operations.
- Litigating courts-martial and administrative separation boards.
- Preparing Soldier disciplinary actions (courts-martial, non-judicial punishment, and other routine matters in administering military justice).
- Providing or coordinating a wide array of administrative and civil law services including (but not limited to) government ethics, labor and employment law, environmental law, health care law, and related litigation.
- Providing legal assistance services.
- Processing foreign claims arising in a field environment.
- Coordinating trial defense services with the TDT cell located in the sustainment brigade (the US Army Trial Judiciary provides trial judiciary services independently).
- Providing technical supervision of legal personnel in the command and its subordinate units.

## **PUBLIC AFFAIRS OFFICER**

2-69. The public affairs officer (PAO) is a personal staff officer who serves as the sustainment brigade's spokesperson. He/She responds to media queries in a timely manner and ensures that the media clearly understands and accurately states the command position. This section anticipates and responds to Soldiers' needs for military and domestic information. It provides media representatives with accreditation, meal, billet, transport, and escort support as authorized and appropriate. The following are some additional duties and responsibilities of the PAO:

- Plans and supervises the command public affairs program.
- Advises and informs the commander of the public affairs impact and implications of planned or implemented operations.
- Serves as the brigade's spokesperson for all communications with external media.
- Assesses the information requirements and expectations of the Army and the public, monitors the media and public opinion, and evaluates the effectiveness of public affairs plans and operations.
- Facilitates media efforts to cover operations by expediting the flow of complete, accurate, and timely information.
- Coordinates sustainment support of civilian journalists under administrative control of the command.
- Conducts liaison with media representatives to provide accreditation, food service, billets, transport, and escorts when authorized and appropriate.
- Develops, disseminates, educates, and trains the command on policies and procedures for protecting against the release of information detrimental to the mission, national security, and personal privacy.
- Informs Soldiers, family members, and DOD civilians of their rights under the Privacy Act, their responsibilities for operations security (OPSEC), and their roles as implied representatives of the command when interacting with news media.
- Coordinates with appropriate staffs to ensure that disseminated public information is consistent with their staff responsibilities.
- Assesses and recommends news, entertainment, and other information needs of Soldiers and home station audiences.

- Works closely with the CMO branch and other agencies to integrate strategy and unify efforts to communicate the Army's perspective and to support the mission's tactical and operational objectives.
- Advises (in coordination with the SJA) the commander and staff on Privacy and Freedom of Information Act matters.

### **UNIT MINISTRY TEAM (UMT)**

2-70. The sustainment brigade UMT consists of at least one chaplain and one chaplain assistant NCO. The mission of the brigade UMT is to perform or provide unit religious support to the command group and brigade staff and to exercise technical supervision over the provision of religious support by subordinate UMTs throughout the brigade's AO. It develops plans, policies, and programs for religious support. It coordinates and synchronizes area and denominational religious support coverage within the brigade. Chaplains personally deliver religious support. They have two roles: religious leader and staff officer. The chaplain as a religious leader executes the religious support mission to ensure the free exercise of religion for Soldiers and authorized personnel. As a personal staff officer, the chaplain serves as an advisor to the brigade commander on matters of religion, moral atmosphere, morale as affected by religion, and the impact of indigenous religions on operations. The chaplain assistant NCO serves as the section NCO In Charge and assists the chaplain in providing religious support. Under the direction of the chaplain, the chaplain assistant NCO coordinates and synchronizes all tactical, logistical, and administrative actions necessary to carry out religious support operations. The chaplain assistant NCO supervises, trains, and mentors subordinate UMT chaplain assistants in military occupational specialty specific tasks; participates in operational staff planning, tracking, and execution; and coordinates and manages protection for the sustainment brigade UMT.

## **SECTION III - THE SPECIAL TROOPS BATTALION (STB)**

2-71. The sustainment brigade's only organic subordinate unit is the STB. The STB provides C2 for assigned/attached personnel and units. The STB has a HQ company (HHC). It integrates the functions of the battalion S-1, S-2, S-3, S-4, and unit ministry team (UMT) staff sections and provides the company to which brigade and STB personnel are assigned. Figure 2-7 depicts a hypothetical STB.

### **STB HEADQUARTERS**

2-72. Consisting of a battalion commander, executive officer, command sergeant major, chaplain, and an S-1, S-2, S-3, and S-4 staff, the STB HQ provides C2 of assigned and attached personnel and units of the STB and directs support for the assigned units. The staff also provides information and advice to supported commanders. Organic to the STB are a HQ company, a food service section, a maintenance section, a trial defense team (TDT), a treatment section (medical), and a UMT. These elements are discussed in the following paragraphs. When augmenting the sustainment brigade, financial management and human resource elements may also be attached to the STB.

### **COMMANDER OF SPECIAL TROOPS BATTALION**

2-73. The commander of STB is responsible for Soldiers assigned to the sustainment brigade HQ that are not assigned or attached to subordinate commands. Besides common staff responsibilities, the STB commander is responsible for the following:

- Developing the sustainment brigade HQ occupation plan.
- Providing for protection of the headquarters and personnel transiting the base, which may include C2 of attached units designated to conduct base defense or other protection missions.
- Arranging for movement and moving the HQ.
- Providing training and morale activities for HQ personnel.

- Providing food service, quartering, medical support, field sanitation, and supply for HQ personnel.
- Receiving and accommodating visitors and augmentees.
- Providing motor transportation organic to or allocated for use by the HQ.
- Maintaining equipment organic to or allocated for use by the HQ.
- Serving as Brigade Headquarters Commandant.

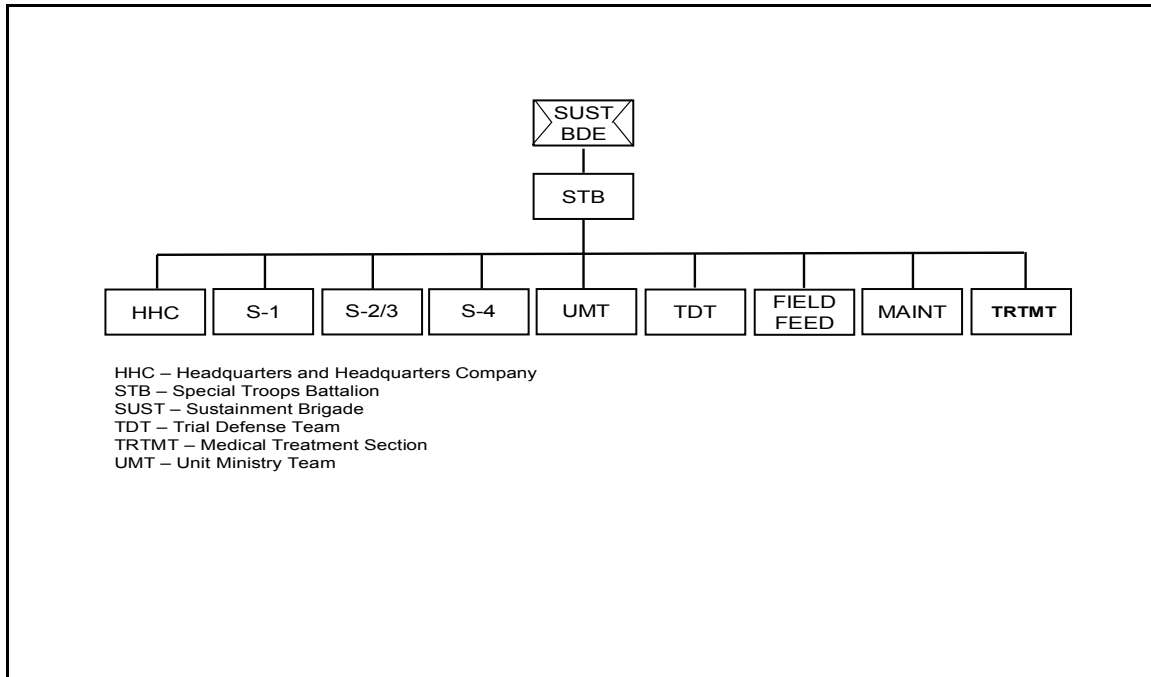

**Figure 2-8. Notional Special Troops Battalion**

### Headquarters and Headquarters Company (HHC)

2-74. The HHC provides C2 and oversight of all company level operations for the sustainment brigade HQ and STB. The HHC is responsible for the Soldiers assigned to the sustainment brigade and STB HQ. Besides common responsibilities, the commander is also responsible for the following:

- Commanding and controlling the company.
- Developing the HQ occupation plan.
- Ensuring local HQ security.
- Arranging for and moving the HQ, unit training, and MWR activities.
- Coordinating food service, billeting, field sanitation, supply, field maintenance for organic equipment and coordinating HSS and FHP.

The supply room utilizes PBUSE to manage STB supplies.

### Food Service Section

2-75. The food service section provides food service for personnel assigned/attached to the STB. See Chapter 4 for further information. The feeding standard is to provide Soldiers at all echelons three quality meals per day. The meals fed depend on the prevailing conditions. Disposing of garbage is important to avoid leaving signature trails and to maintain field sanitation standards.

### Maintenance Section

2-76. The maintenance section provides field maintenance for vehicles and equipment assigned to the STB. It is the primary field maintenance provider for the sustainment brigade HQ, the STB, all assigned/attached assets smaller than battalion-level and not assigned to a battalion. Units or elements of the support maintenance company (SMC) or an attached component repair company (CRC) support the maintenance section with sustainment level maintenance, when required. The maintenance section has a standard Army maintenance system (SAMS) which supports maintenance functions for the whole brigade and also readiness reporting for the brigade.

### Trial Defense Team (TDT)

2-77. The TDT is assigned to the HHC of the STB, but attached to the US Army Legal Services Agency for all purposes except administrative and logistics support (in accordance with Chapter 6, Army Regulation (AR) 27-10; and FM 27-100). The Commander, US Army Legal Services Agency exercises complete Uniform Code of Military Justice (UCMJ) and disciplinary authority over all TDT personnel. The Chief, US Army Trial Defense Service exercises independent supervision, control, and direction over all TDT personnel and their mission. The primary mission of the TDT is to provide trial defense support to Soldiers and other authorized recipients within the assigned AO. That entails two essential tasks:

- Organize, control, sustain, and assess defense services.
- Provide defense services.

2-78. Specifically, as regards providing defense services, it offers Priority I defense services, which include:

- Representing Soldiers at general and special courts-martial.
- Represent Soldiers at article 32 UCMJ proceedings.
- Represent Soldiers during investigations.
- Counsel pretrial detainees.

It also offers Priority II defense services, which are:

- Provide consultation for Soldiers facing formal article 15 UCMJ proceedings.
- Represent Soldiers at administrative elimination boards.
- Provide consultation for Soldiers suspected of criminal offenses.
- Represent Soldiers at lineups.
- Provide consultation for Soldiers facing summary courts-martial.
- Represent Soldiers at grade reduction boards.
- Represent recruiters facing misconduct allegations.
- Provide consultation for Soldiers facing administrative separation that are not entitled to a board.

The TDT also offers Priority III defense services, which include:

- Support legal assistance operations.
- Assist with other legal services.

### Unit Ministry Team (UMT)

2-79. The STB UMT consists of one chaplain and one chaplain assistant. The mission of the STB UMT is to provide and perform unit religious support to Soldiers, families, and authorized civilians as directed by the STB commander. The UMT provides area and denominational religious support in accordance with the brigade religious support plan under the technical supervision of the sustainment brigade chaplain. Chaplains personally deliver religious support. They have two roles: religious leader and staff officer. The chaplain as a religious leader executes the religious support mission, to ensure free exercise of religion for Soldiers and authorized personnel. The chaplain is a personal staff officer and serves as an advisor to the

STB commander on matters of religion, moral atmosphere, morale as affected by religion, and the impact of indigenous religions on operations. The chaplain assistant is a Soldier trained to assist the chaplain in providing religious support. Under the direction of the chaplain, the chaplain assistant coordinates and synchronizes all tactical, logistical, and administrative actions necessary to carry out religious support operations. The chaplain assistant coordinates and manages protection for the STB UMT.

### **MEDICAL PLATOON**

2-80. The medical platoon provides AHS support for HSS and FHP for the sustainment brigade HHC and operate under the supervision of the sustainment brigade surgeon. The medical platoon is organized with a HQ section, a treatment squad, and one ambulance squad. The medical platoon is primarily responsible for providing Role 1 medical care to the HHC and to other sustainment brigade subordinate units located in the HHC base cluster. This care includes emergency medical treatment advanced trauma management (ATM) and sick call services. The medical platoon uses the MC4 system to support the brigade.

#### **Medical Platoon Headquarters**

2-81. The medical platoon headquarters section provides command, control, communications, and resupply for the medical platoon. The platoon HQ consists of the medical platoon leader (the field surgeon also assigned as a member of a medical treatment team) and the platoon sergeant (E-6, health care sergeant) that also serves as a member of a treatment team. The medical platoon is dependent on the surgeon section for planning, coordination, and synchronization of HSS/FHP missions. The platoon uses Movement Tracking System (MTS) to track MTS-equipped ambulances. See FM 4-02.4 and FM 8-55 for additional information on planning, preparation, and execution of HSS activities.

#### **Treatment Squad**

2-82. The treatment squad consists of two treatment teams; Alpha and Bravo. These teams operate the Role 1 medical treatment facility (MTF) and provide medical care and treatment for the sustainment brigade.

#### **Ambulance Squad**

2-83. Medical platoon ambulances provide ground ambulance evacuation primarily within the sustainment brigade AO. Ambulance team personnel provide medical evacuation and en route care from a Soldier's point of injury or a casualty collection point to the sustainment brigade Role 1 MTF.

## **SECTION IV - FUNCTIONAL ORGANIZATIONS**

2-84. The FM and HR organizations covered in this section are not organic to the sustainment brigade. When they are attached to the sustainment brigade, they are usually further attached to the STB and might alternately be attached to a CSSB as mission dictates.

### **FINANCIAL MANAGEMENT COMPANY (FM CO)**

2-85. FM companies provide financial management support to BCTs and other units in the sustainment brigade AO. The FM CO exercises C2 over company headquarters section and three to seven FM detachments. The FM CO provides support on an area basis within an AO, to include support to joint and multinational commands, units, Soldiers, and authorized civilians and contractors. The theater FMC, FM SPO, and G-8 provide technical coordination to all FM COs within their AO. Their mission is to analyze the supported commander's tasks and priorities to identify the financial resource requirements that will enable mission accomplishment. The functions of planning and integrating financial management operations will be provided from the financial management branch within the sustainment brigade support operation section.

2-86. The FM company relies on the Financial Management Tactical Platform (FMTP) as an integrated system with multiple software capabilities. FM operations depend on electronic submission of finance documents through the FMTP to Defense Finance and Accounting Service for disbursing, vendor support, and travel and military pay.

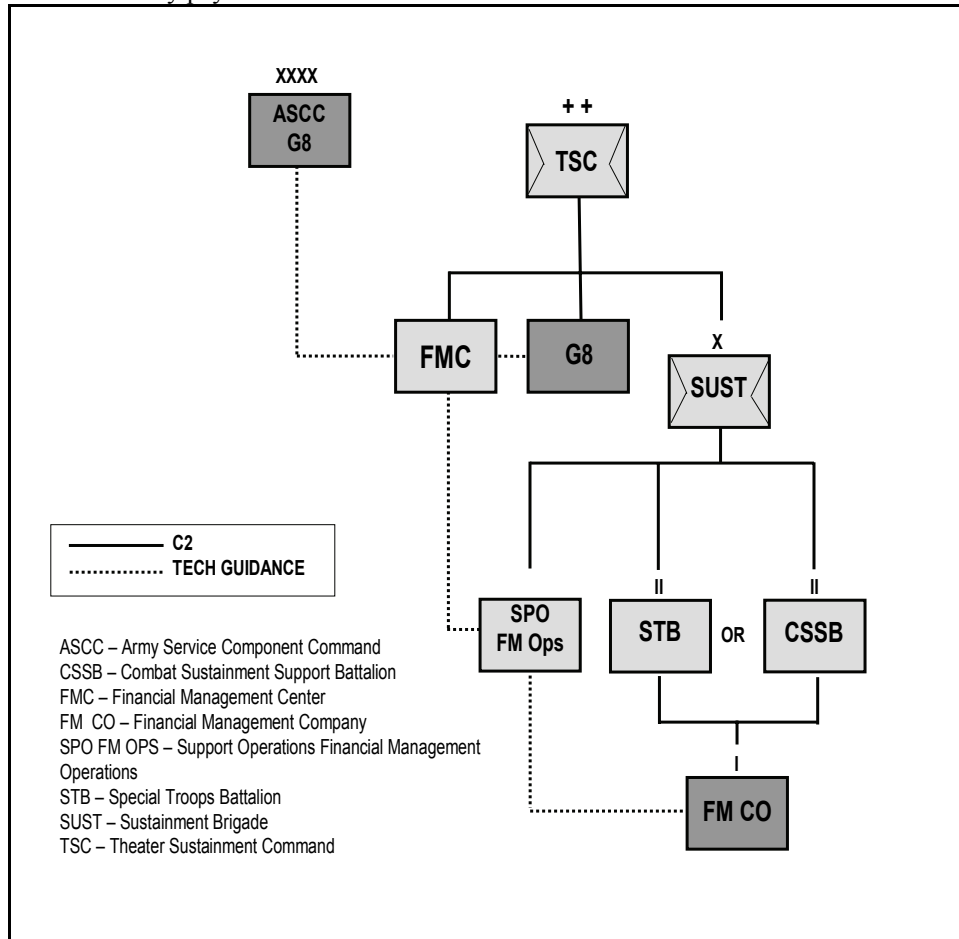

Figure 2-9. Placement of Financial Management Organizations

## HUMAN RESOURCES (HR) COMPANY, PLATOONS OR TEAMS

2-87. The HR company delivers HR area support for postal; reception, replacement, rest and recuperation, return to duty, and redeployment (R5) personnel accountability; and casualty operations in the deployed AOR. The HR company can be tailored for a postal, R5, or combined mission by task organizing the company headquarters with specialized postal teams or R5 plans and operations teams.

- An HR company (postal) consists of a company headquarters, a postal plans and operations team (with postal directory capability), and between two and six postal platoons. It either provides Defense Post Office area postal support or supports MMT operations.
- An HR company (R5) consists of the R5 plans and operations team (includes data integration capability), two to six R5 platoons, each of which has two or three R5 Personnel Accounting Teams to execute R5 personnel accountability operations at intra-theater APODs or supports the TG R5 center at the inter-theater APOD.
- Small AORs may receive postal and R5 support from the same HR company. HR companies are assigned to the Sustainment brigade STB or CSSB. They may also operate under the C2 of a TG R5 Task Force, if created by the Sustainment brigade commander.

- HR companies receive technical guidance from the HR operations cell in the Sustainment Brigade and ESC SPO and from the Human Resource Sustainment Center (HRSC) in the TSC. HR companies do not support essential personnel services, MWR, or personnel readiness management operations executed by S-1 and G-1 sections as defined by the Personnel Services Delivery Redesign (PSDR).

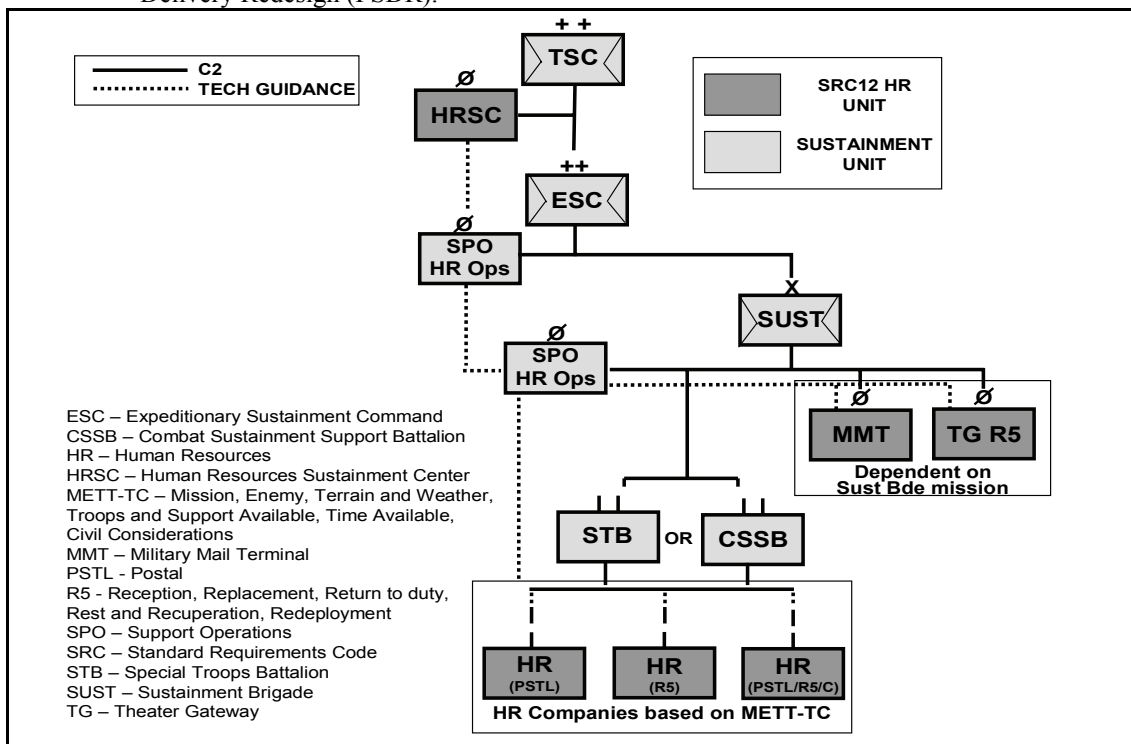

Figure 2-10. Placement of Human Resources Organizations

2-88. The MMT is a LTC-led team which provides specialized equipment and the expertise to establish the Army element of a joint MMT with the augmentation of a HR company (postal) in the port area which coordinates, receives, and processes incoming theater mail and dispatches retrograde mail to Continental United States (CONUS). The MMT team will deploy initially with the Sustainment brigade with the TO mission and will then transition to a theater distribution role. The MMT team can serve as the C2 element of a MMT task force if formed in conjunction with an HR company (postal) by the Sustainment brigade commander.

2-89. The TG R5 is a LTC-led team which forms the TG R5 center when augmented with an HR company (R5). It coordinates and executes R5 operations at the inter-theater APOD to gain and maintain personnel accountability of personnel entering, departing, or transiting the theater at the APOD. The team further coordinates the execution of required supporting transportation activities and life support operations for transient personnel into and out of the TG R5 center. The TG R5 team operates as an element of the Sustainment brigade with TO mission initially and subsequently transitions to a TD role. The TG R5 team can serve as the C2 element of a TG R5 task force if formed in conjunction with an HR company (R5) by the Sustainment brigade commander.

## SECTION V – DISTRIBUTION AND MATERIEL MANAGEMENT

2-90. Distribution management is the process of planning and synchronizing the time definite delivery of materiel, equipment, units, personnel, and services to, within, and from the AO. Distribution management involves the fusion of information derived from a number of processes: commander's oversight, Army Battle Command Systems, physical distribution, and materiel management. The premise of the distribution



operations in the current force is to reduce the time it takes the right supplies (both demand supported and bulk) to travel from the source of supply to the point of need. The transformed distribution management system will eliminate reliance on stockpiles and static inventories located forward at each echelon, which was a characteristic of the old Army of Excellence supply-based system. Distribution substitutes speed for mass, makes use of a COP providing situational understanding, and ensures efficiency of delivery systems, while ensuring visibility of assets in the pipeline. In essence, the distribution system becomes the “warehouse,” representing “inventory in motion” reducing both the organizational and materiel footprint within the AO. Logisticians control the destination, speed, and volume of the distribution system. The key elements of distribution management (C2, physical distribution, and materiel management) are further amplified below. The commander (in concert with guidance from superior HQ) provides the priorities and mission plan for units. The commander’s guidance, in conjunction with the readiness shortfalls for that unit, determines the priorities for materiel delivery and fulfillment. Included in physical distribution are not only the vehicles themselves, but also the management of movement, routing, ITV assets, facilities, and material handling equipment.

## COMMAND AND CONTROL OF DISTRIBUTION

2-91. The Army conducts distribution management at all levels from strategic to tactical. One of the key components of the modular force concept is to have centralized C2 of units at EAB. As such, the TSC is the central distribution manager for the theater of operations. The sustainment brigade is responsible for managing distribution within its assigned AO by balancing the existing capabilities of the distribution infrastructure with the day-to-day and projected operational requirements. The Sustainment brigade issues distribution directives to CSSBs, which in turn issues directives to transportation companies for execution. The Sustainment brigade and CSSBs command all sustainment forces inside their assigned areas. The BSB is not under the command of the TSC, or Sustainment brigade, but rather is their supported unit. The BSB SPO issues distribution directives to the Distribution Company to replenish the FSCs.

2-92. Effective distribution management applies the principles of managing distribution centrally, optimizing infrastructure, minimizing stockpiles, maximizing throughput, and maintaining a seamless pipeline. The TSC’s role in distribution management is in the development of the theater’s distribution. The TSC’s DMC coordinates and monitors the strategic distribution flow with USTRANSCOM. The DMC collects, analyzes, and monitors ITV distribution flow and executes changes in the distribution priorities established by ASCC G-4. The ESC performs the same function except it is confined to its theater of operation. It monitors and provides updates to the time definite delivery schedules and distribution priorities in accordance with ARFOR G-4 and TSC SPO guidance.

2-93. The sustainment brigade collects and analyzes ITV distribution information to monitor routes and locations of its convoys. This assists in movement control for convoy protection through a unit’s AO. The Sustainment brigade also uses the ITV to establish delivery schedules to its CSSBs in support of the TSC and/or its supported command’s priority of supply and effort. The BSB focuses on delivering timely, dependable, accurate, and consistent support to the BCT through the FSCs. It monitors and tracks any inbound Sustainment brigade convoys to synchronize protection issues. The SPO synchronizes and establishes delivery schedules to the FSCs through the BSB’s Distribution Company.

## PHYSICAL DISTRIBUTION

2-94. Physical distribution is defined as the facilities, installations, platforms, and packaging needed to physically store, maintain, move, and control the flow of military materiel, personnel, and equipment between the point of receipt into the military system and the point of issue to using activities and units; including retrograde activities. The Sustainment brigade manages distribution nodes in its assigned AO. The Sustainment brigade and CSSB track and maintain visibility of assets (ground and aerial platforms) that are available for distribution. The CSSB maintains visibility of its capacity to store commodities as another aspect of physical distribution. The level of physical distribution increases from the TSC to the BSB while the level of distribution management decreases. The TSC and ESC’s roles in physical distribution are minimal. However, visibility is still maintained over theater distribution assets within the

distribution network. The ESC maintains visibility of theater of operations distribution assets. The TSC and ESC can direct cross-leveling of distribution resources to meet tactical requirements to optimize the distribution flow.

## **MATERIEL MANAGEMENT**

2-95. Materiel management is the supervision and management of supplies and equipment throughout the strategic, operational, and tactical level areas of operation that includes cataloging, requirements determination, procurement, overhaul, and disposal of materiel. Materiel management is the monitoring and control of on-hand stocks, ensuring quality control, requirements determination, local purchase, retrograde, and distribution of materiel. It also provides visibility to the distribution management effort of assets in stationary stocks at all echelons. A portion of materiel management is maintenance management which provides oversight of parts requirements and also projections of parts availability (return of reparable, for instance).

### **MATERIEL MANAGEMENT TRANSITION FROM LEGACY FORCE TO MODULARITY**

2-96. The transition to a modular force has resulted in new organizations replacing the familiar structure of materiel management centers. While the changes are significant, all of the functions of materiel management will continue to be performed in better, more efficient ways. The major change under modular design is the elimination of the legacy materiel management centers (MMC) at the division and corps level. The functions of the Division Materiel Management Center (DMMC) and Corps Materiel Management Center (CMMC) have migrated to the Distribution Management Centers (DMC) located in the TSC primarily and within the ESC and the sustainment brigade SPO as delegated. The asset visibility sections from these centers have been moved to the division and corps G-4 shops to enable the G-4 to see the status of property within the division or corps and take what actions the division or corps commander may direct for the units assigned or attached to the division. Enablers coming on line will make materiel management easier and more logical. Some of these enablers are: PBUSE, the Single Army Logistics Enterprise, and Business Intelligence tools. Figure 2-11 illustrates the migration of some of the materiel management functions from AOE units to current units.

AOE	Category	Modular Force
<ul style="list-style-type: none"> <li>• <b>Property Book Management</b> <ul style="list-style-type: none"> <li>– Division: DMMC</li> <li>– Non-Division: Embedded PBO at Brigade</li> </ul> </li> <li>• <b>Asset Visibility: DMMC/CMMC/TMMC</b></li> </ul>	<p><b>Class VII Property Accountability Asset Visibility</b></p>	<ul style="list-style-type: none"> <li>• <b>Property Accountability: BDEs (BCTs and SPT BDEs) with embedded PBOs</b></li> <li>• <b>Asset Visibility: Division/Corps/Army Service Component Command (ASCC) G-4</b></li> </ul>
<ul style="list-style-type: none"> <li>• <b>DMMC, CMMC, TMMC</b> <ul style="list-style-type: none"> <li>– Overlapping redundancy</li> </ul> </li> </ul>	<p><b>General Supplies Class I, Water, Class IIIB</b></p>	<ul style="list-style-type: none"> <li>• <b>TSC, ESC (if utilized), SUST BDE DMC manages stocks</b></li> <li>• <b>BCT requirements sent to TSC/ESC DMC through supporting SUS BDE</b></li> </ul>
<ul style="list-style-type: none"> <li>• <b>DMMC (DAO): Coordinates and controls Class V use within the Division</b></li> <li>• <b>CMMC: Managed Corps CSAs/ASPs</b></li> <li>• <b>TMMC: Managed Theater TSA/ASPs</b></li> <li>• <b>TMMC ICW ASCC G-3: Establish CSRs</b></li> </ul>	<p><b>Class V</b></p>	<ul style="list-style-type: none"> <li>• <b>BSB BAO: Coord BCT requirements</b></li> <li>• <b>Div/Corps G-4: Planning and oversight</b></li> <li>• <b>TSC/ESC/SUST BDE: Manage stocks, issues MROs to CSSBs ASAs</b></li> <li>• <b>TSC ICW ASCC G-3: Establishes CSRs/Stockage Obj/NICP requisitions</b></li> </ul>
<ul style="list-style-type: none"> <li>• <b>DMMC/CMMC/TMMC with duplication at Division/Corps/Theater G-4</b></li> </ul>	<p><b>Maintenance/Readiness Management</b></p>	<ul style="list-style-type: none"> <li>• <b>BSB: maint mgmt/readiness for its BCT</b></li> <li>• <b>Division/Corps G-4: Monitors readiness information for CDR, establishes priorities, write plans/orders</b></li> </ul>
<ul style="list-style-type: none"> <li>• <b>Managed by hierarchal MMCs (DMMC, CMMC, TMMC)</b></li> <li>• <b>Each level conducted manager reviews with SARSS-2 boxes</b></li> <li>• <b>SARSS data communicated to hierarchal boxes (SARSS-1 to SARSS-2A/D to SARSS-2A/C)</b></li> </ul>	<p><b>Demand Supported Class II, IIIP, IV, IX</b></p>	<ul style="list-style-type: none"> <li>• <b>SUST BDE single face to the customer</b></li> <li>• <b>Overall centralized management at the TSC/ASC or ESC (if utilized)</b></li> <li>• <b>Time sensitive RIC GEO functions pushed to SUST BDEs as required</b></li> <li>• <b>SARSS-1 data communicated to CTASC directly</b></li> </ul>

Figure 2-11. Modularity Materiel Management Migration

## ORGANIZATIONAL ROLES IN MATERIEL MANAGEMENT

### Army Sustainment Command (ASC)

2-97. This is the single Army national materiel manager for units stationed in the CONUS. ASC is a subordinate unit of the Army Materiel Command. It provides continuous equipment and materiel readiness to CONUS forces through effective planning, resourcing, and materiel and distribution management in accordance with the Army Force Generation (ARFORGEN) process. It achieves this by synchronizing strategic with operational and tactical logistics and by integrating acquisition, logistics, and technology. It accomplishes this in order to quickly and efficiently generate and project combat power to support expeditionary operations. It is, for all practical intents and purposes, the “CONUS TSC” and performs the same materiel management functions for units in CONUS that a TSC would for deployed forces.

### Theater Sustainment Command (TSC)

2-98. The TSC manages materiel for all Army forces assigned or deployed within the assigned region and, as appropriate, for joint, multinational, and international forces. TSC managers are linked with the G-4s in their areas of operations for resource prioritization. The TSC also coordinates with the AMC Field Support Brigade Commander to support national-level system and materiel requirements.

### Expeditionary Sustainment Command (ESC)

2-99. The ESC synchronizes the AO distribution systems and provides distribution oversight. The ESC can assist in tracking where requests are in the supply system and coordinates distribution assets when appropriate to redirect essential items based on the priority of support and the division or corps commander’s priorities.

## Sustainment Brigades

2-100. Sustainment brigades execute the materiel management and distribution guidance from the TSC or ESC (from ASC for those sustainment brigades stationed in CONUS when not deployed). When the ESC is deployed, the command relationship with the ESC enables the TSC to issue directives to redistribute and surge logistics capabilities across the theater of operations to fulfill requirements as needed. The sustainment brigade SPO interfaces with the TSC or ESC (or ASC) materiel managers for asset management, visibility, and distribution to support the division or any other assigned customer units. When deployed, sustainment brigades provide physical distribution and distribution management of materiel to brigade combat teams and echelons-above-brigade units as part of a theater-wide distribution process and area support to units within an assigned AO, normally under the C2 the TSC or its ESC.

2-101. Sustainment brigades operate from operational to tactical levels. Within guidance provided by the TSC, they actively execute specific materiel management functions at these levels of operation. The Sustainment Brigades manage the execution of multifunctional and functional logistics. They provide support within the assigned AO with their internal stocks and support of other requirements above and beyond the BSB capabilities. They interface with the TSC materiel managers for asset management, visibility, and distribution to support customers. They execute the materiel management and distribution guidance from the TSC.

### *Materiel Management Functions and Responsibilities of the Sustainment Brigade Support Operations Office (SPO)*

2-102. The SPO is responsible to the sustainment brigade commander for a number of critical sustainment functions. The scope of materiel management decreases in theater of operations as the materiel flows from TSC to sustainment brigade, to BSB. The sustainment brigade SPO's focus is on limited materiel management functions that are critical to their subordinate units. The TSC may delegate additional materiel management functions forward to meet any time sensitive requirements.

2-103. The below listed functions include the primary materiel readiness and management roles of the SPO section:

- Assist the TSC/ESC materiel management Distribution Management Center (DMC) with problems in their MRF.
- Work with the TSC/ESC and Army Authorized Stockage List (ASL) team to implement ASL changes.
- Intensively manage and coordinate all aircraft on the ground and Aviation Intensive Management Item issues.
- Manage performance reports and perform monthly review and analysis.
- Monitor customer wait time and ASL fill rate.
- Manage the retrograde program of The Standard Army Retail Supply System (SARSS-1) sites in their area of responsibility to ensure equipment gets properly processed, tagged, and sent to the proper locations.
- Manage the Depot-Level Repairable top 30 report.
- Reconcile the Over-age Recoverable Items Listing with subordinate units.
- Provide supply discrepancy reports as necessary and local purchase management.

2-104. The following are some enablers of materiel management at the sustainment brigade:

- SARSS-1.
- CTASC (fly-away system).
- Logistics Information Warehouse.

### *Combat Sustainment Support Battalions (CSSBs) and Brigade Support Battalions (BSBs)*

2-105. Both of these units perform materiel management, within their capabilities, for supported units. Both the CSSB and the BSB are enabled with visibility through STAMIS such as PBUSE, SARSS-1,

SAAS–MOD and SAMS, the Unit Level Logistics System-Aviation Enhanced (ULLS–AE), and the MTS. All are enabled to perform logistics C2 through BCS3.

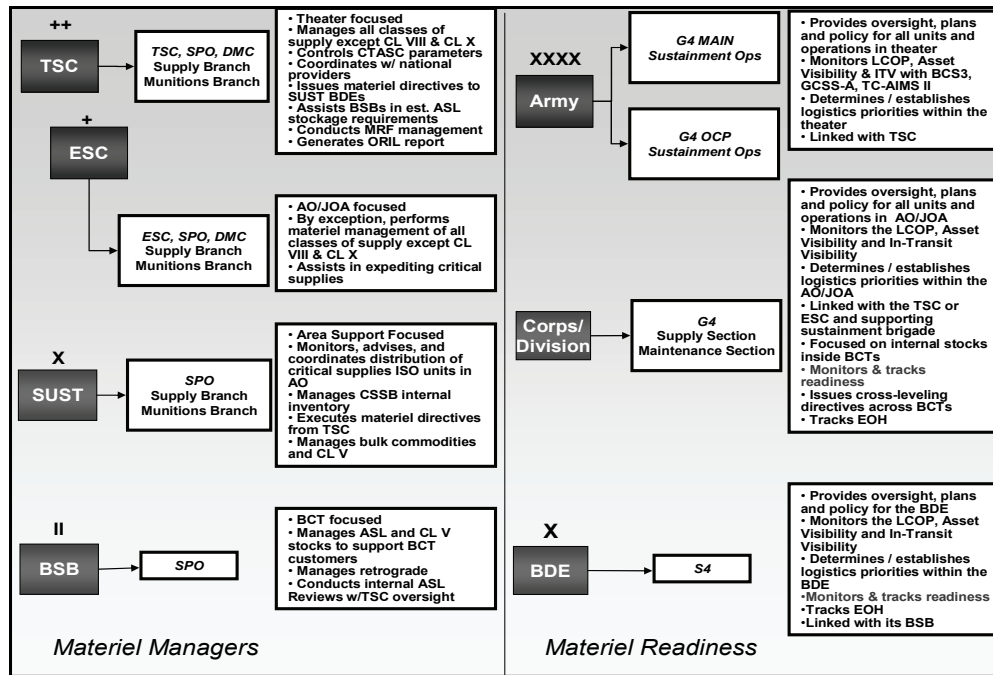

Figure 2-12. Materiel Management Agencies and Functions Throughout the Theater of Operations

## REPORTING AND RELATIONSHIPS

2-106. Material management reports need to flow in two channels. Reporting will flow through command channels to keep the higher maneuver HQ apprised of the strength and capabilities of subordinate units. Therefore BSBs will report to their BCT HQ S-4, which will report to division and corps HQ G-4, and so on. However, since BCTs, divisions, and corps are not sources of sustainment, the BSB's and aviation support battalions should submit their requirements and forecasts to their supporting sustainment brigade in order to get required support. When reporting electronically, all involved echelons in the sustainment chain that have an interest should be copied on the report; especially the ESC and TSC HQ. Of course, when all parties are using BCS3, reports are not necessary since relevant information is populated in BCS3. Everyone on the network can see and utilize the reported information. One of the fundamental principles of the modular force logistics concept is "centralized EAB logistics C2," which will enable the most efficient and effective end-to-end distribution process. It is essential that EAB logistics planners be synchronized with corps, division, and brigade logistics planners so that a maximum amount of collaborative planning can occur routinely from day to day. Figure 2-13 below demonstrates this reporting concept.

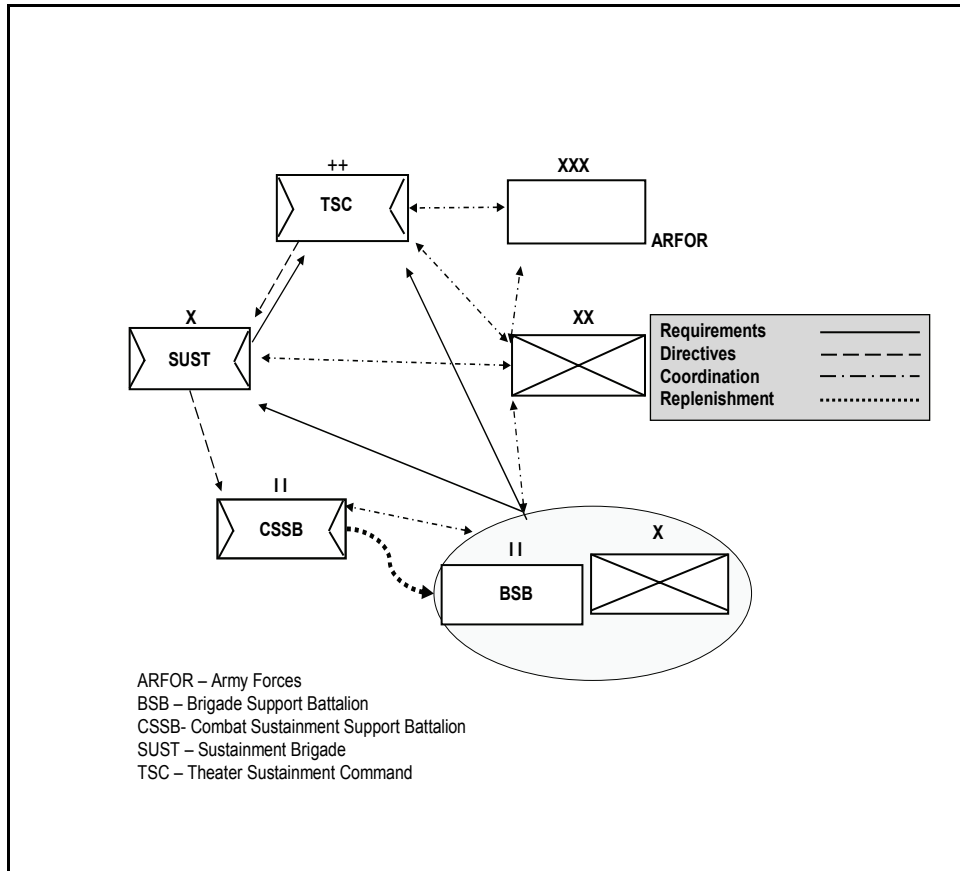

Figure 2-13. Requirements Flow

## Chapter 3

# COMMAND, CONTROL, AUTOMATION, AND COMMUNICATION

As an integral component of the joint and Army battlefield communications network, the sustainment brigades employ satellite and network-based communications that enable C2, visibility of the distribution system, and identification of support requirements. The COP is a joint requirement to provide visibility of data and decision-support tools needed to manage a joint distribution system. This chapter also describes the command relationships that support the C2 responsibilities of the sustainment.

### SECTION I – COMMAND AND CONTROL

#### ROLE OF THE COMMANDER

3-1. The commander's role is to establish a command climate for the command, prepare it for operations, direct it during operations, and continually assess subordinates. Commanders visualize the nature and design of operations through estimates and input from subordinates. They describe support operations in terms of time, space, resources, purpose, and action; employing intent, commander's critical information requirements, and mission orders to direct planning, preparation, and mission execution.

3-2. Commanders direct with mission orders. Mission orders enable subordinate commanders to understand the situation, their commander's mission and intent, and their own mission. The commander's intent and concept of operations set guidelines that provide unity of effort while allowing subordinate commanders to exercise initiative in planning, preparing, and executing their operations. Mission orders stress not only the tasks required of subordinates but also understanding their context and purpose.

#### SUBORDINATE UNITS AND ACTIVITIES

3-3. The sustainment brigade provides C2 for all organic and attached elements. These include the STB and any assigned or attached CSSBs, functional battalions, and any DA personnel and/or contractors.

#### LIAISON REQUIREMENTS

3-4. The sustainment brigade may find requirements for liaisons to provide improved communications with higher and/or supported units. This situation is most likely to be found when the sustainment brigade is in support of joint or multinational forces. Language, customs, and cultures can become issues even in joint operations. These issues may be more pronounced when support is provided to a multinational force, potentially increasing the liaison requirement.

#### STAFF FUNCTIONS

3-5. Staffs provide commanders with relevant information in usable forms that help commanders achieve accurate situational understanding. Situational understanding enables commanders to make timely decisions and allows staffs to rapidly synchronize, integrate, and fuse actions in accordance with the commander's intent. For detailed information on the organization and functions of the sustainment brigade staff, see Chapter 2.

## COMMAND AND CONTROL (C2) SYSTEM

3-6. Commanders employ a C2 system – a combination of people, organizations, technological means and resources, and procedures – to allocate resources and direct the execution of support operations. The commander's C2 system manages information to produce and disseminate a common operational picture (COP) to the commander, staff, and subordinate units. The goal is to provide knowledge based on relevant information to which they can apply judgment to reach situational understanding and discern operational advantages. An effective C2 system allows the commander to:

- Operate freely throughout the AO and exercise C2 from anywhere in the operational area.
- Delegate authority to subordinate commanders and staff to allow decentralized execution of operations.
- Synchronize actions throughout the AO.
- Focus on critical actions instead of details.

### SECTION II - AUTOMATION

3-7. Automation systems give leaders the ability to penetrate some of the fog of war by providing near real time situational awareness. Automated data feeds for both logistics and C2 information enable the commander to read the situation and anticipate requirements.

3-8. The Army has fielded a number of systems that give commanders a more timely and accurate view of the situation in order to better support the tactical operation. These systems generally fall into two categories: C2 automation systems and business process systems. This section provides an introduction and a brief description of these systems which include C2 systems, Army Battle Command System (ABCS), LandWarNet, and STAMIS, such as SARSS, SAMS-E, and PBUSE.

## C2 AUTOMATION SYSTEMS

3-9. C2 automation systems provide commanders with data integrated from a variety of sources to include other information systems and STAMIS. This accumulated data enhance the commander's situational awareness and help to increase situation understanding. While not a replacement for the Military Decision Making Process, C2 automation systems provide tools to aid commanders and their staffs in the decision making process.

## ARMY BATTLE COMMAND SYSTEM (ABCS)

3-10. ABCS is the integration of fielded, developmental, future battlefield automated systems, and communications employed in training and tactical environments, in developed and undeveloped theaters, and in fixed installations and mobile facilities. ABCS allows for a System of Systems concept. Ultimately, the System of Systems will essentially provide the Soldier with the same type of service that the Internet provides to its customers today. In the commercial environment, customers can access the Internet from separate computers without even knowing the location of the network they are attached to. In the future, the Soldier will have a similar capability when using the ABCS, allowing a commander to see multiple systems on one screen and seamlessly pass data from one program to the next. See Figure 3-1 for a pictorial of ABCS. ABCS in use are:

- Global Command and Control System-Army (GCCS-A).
- Maneuver Control System (MCS).
- All Source Analysis System (ASAS).
- Battle Command Sustainment Support System (BCS3).
- Air and Missile Defense Planning and Control System.
- Force XXI Battle Command, Brigade and Below (FBCB2).
- Tactical Airspace Integration System (TAIS).
- Digital Topographic Support System (DTSS).



- Integrated Meteorological System (IMETS).
- Integrated Systems Control (ISYSCON)

### **GLOBAL COMMAND AND CONTROL SYSTEM – ARMY (GCCS-A)**

3-11. GCCS-A is the Army link for ABCS to the Global Command and Control System (GCCS). GCCS-A will provide a suite of modular applications and information and decision support to Army strategic and operational theater-level planning for theater operations and sustainment. GCCS-A supports the apportionment, allocation, logistics support, and deployment of Army forces to the combatant commands. Functionality includes: force tracking, host nation and CMO support, theater air defense, targeting, psychological operations, C2, logistics, medical, provost marshal, counter-drug, and personnel status. GCCS-A will be primarily deployed from corps to division.

### **MANEUVER CONTROL SYSTEM (MCS)**

3-12. MCS is the primary battle command information source, providing the common operational picture, decision aids, and overlay capabilities to support the tactical commander and the staff. This is done via interface with the force level information database populated from the other Battlefield Automated System. MCS will satisfy information requirements for a specific operation, track resources, display situational awareness, effect timely control of current combat operations, and effectively develop and distribute plans, orders, and estimates in support of future operations. It will also support the military decision making process.

### **FORCE XXI BATTLE COMMAND, BRIGADE AND BELOW (FBCB2)**

3-13. FBCB2 is a suite of digitally interoperable applications and platform hardware. The suite is designed to provide on-the-move, real-time, and near-real-time situational awareness as well as C2 information to sustainment leaders from brigade to the platform and Soldier level. FBCB2 is a mission essential sub-element and a key component of ABCS. FBCB2 will feed the ABCS common database with automated positional friendly information and current tactical battlefield geometry for friendly and known/suspected enemy forces. Common hardware and software design will facilitate training and standard operating procedures.

### **BATTLE COMMAND SUSTAINMENT SUPPORT SYSTEM (BCS3)**

3-14. BCS3 is the Army's logistics C2 automation system. It aligns sustainment, in-transit, and force data to aid commanders in making critical decisions. This system capability provides operators the complete operational picture in the form of total asset visibility to quickly and efficiently see the status of selected critical items. BCS3 provides a visual of the operational area through a map centric display. The system's software is capable of running on classified or unclassified networks. It provides the ability to plan, rehearse, train, and execute on the same system. The system provides sustainment and movement information for command decisions by displaying current status and the tools to determine future projections of fuel, ammunition, critical weapons systems, and personnel. It integrates actionable data from numerous available ABCS and STAMIS to support battle command. BCS3 is fielded at every echelon from theater through the brigade and will support predictive sustainment based on the impact of dues-in and the status of combat essential items such as fuel, ammunition, weapons systems, and personnel. BCS3 has four main functional features which, together with medical and movement information, encompass the overall logistics common operational picture (COP):

- **Deployment/Redeployment/RSO Tracking:** BCS3 enables better tracking of unit assets through the deployment and RSO processes by leveraging radio frequency (RF)-in-transit visibility (ITV) technology and manifest information from systems such as the Global Air Transportation Execution System (GATES) and the Worldwide Port System (WPS).
- **Logistics Reporting:** BCS3 provides a method of reporting that is based on Excel spreadsheets at the unit source data level, and can be easily input into the first BCS3 database in the

organization architecture. Once the data is consolidated and updated, reports can be tailored to the individual using unit's desires (see Appendix C).

- Convoy Tracking:** Through the employment of MTS and other satellite based tracking systems, BCS3 facilitates convoy planning and execution management. Above all, BCS3 provides a near real-time picture of convoy movement and provides commanders with the capability to communicate directly with vehicles equipped with different satellite based tracking devices. The map-centric display can be tailored to meet the needs of the user and can be as focused or expanded as the mission dictates. Proximity alerts can also be established to warn of convoy or individual vehicle deviation from prescribed route or plan.

Note: proximity alerts are not restricted to convoy management; a proximity alert is an event based tool that can be set up to inform the user when a specified event occurs.

- Commodity Management:** This tool provides the commander with enhanced distribution management, to include ITV and location of stocks and storage on the ground. The system provides a map-centric view from joint and strategic system, facilitating efficient planning and execution for units, their task organization, supply point locations, and tracking of inbound supplies and spares. The system provides the ability to portray supply points and SSA on-hand assets. BCS3 also generates reports by Class of Supply or commodity.

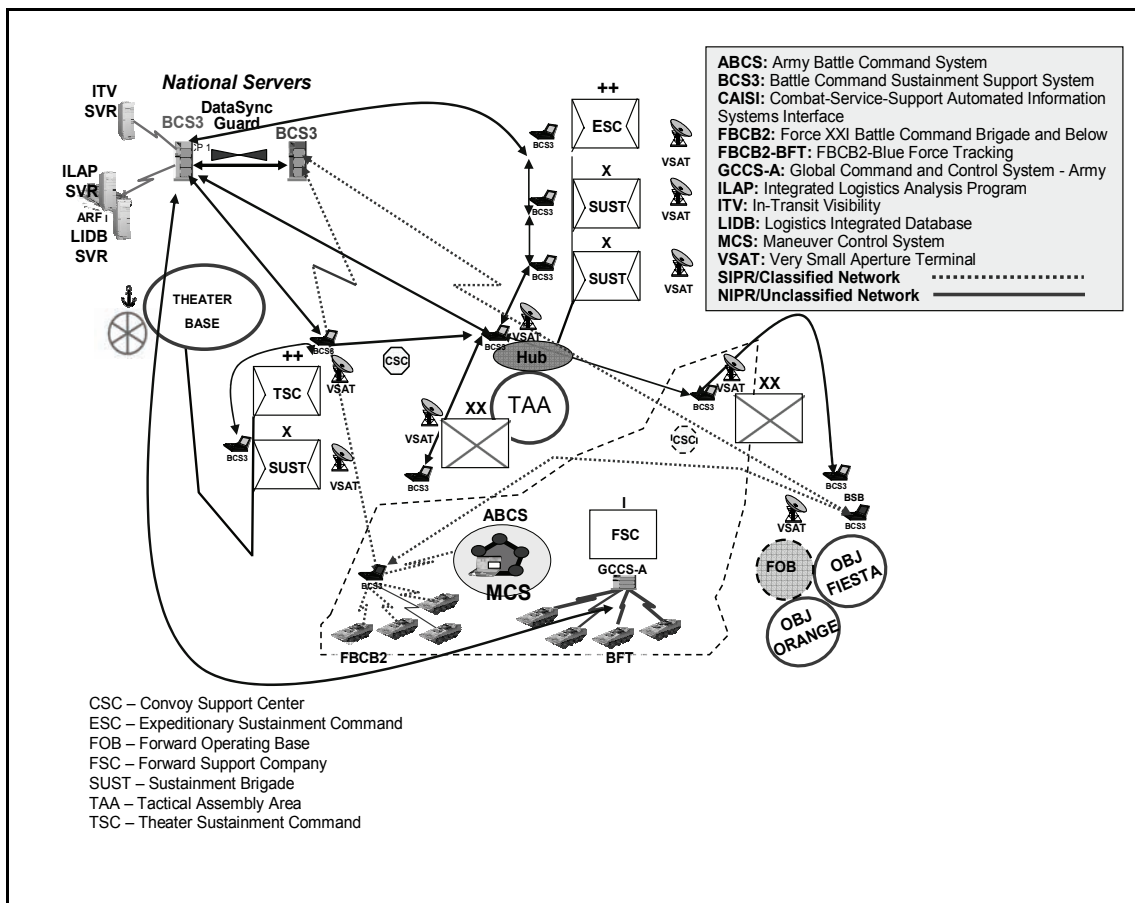

Figure 3-1. C2 Automation Systems and BCS3

3-15. BCS3 also provides the following capabilities:

- **Visibility of Current and Future Combat Power:** BCS3 provides the maneuver commander the capability to assess current combat power. This staff running estimate provides the status of fuel (Class III [B]), ammunition, weapons platforms/equipment, and personnel. BCS3 also provides the maneuver commander the capability to predict future combat power displayed in 24-hour increments (up to 96 hours) for the current task organization.
- **Commander's Critical Information Requirements (CCIR) Tracking with Alerts:** BCS3 enables commanders to track resources and establish automated CCIR alerts when critical resources require tracking or are below required levels. Critical supply indicators can be pre-set to automatically alert commanders when they fall below prescribed levels. The user can also set up an exception report so BCS3 depicts the mission capable status of weapons platforms, personnel, and equipment. The CCIR alert is a visual and/or audio cue that prompts the user that the parameter has been exceeded.

## STANDARD ARMY MANAGEMENT INFORMATION SYSTEMS

3-16. STAMIS provide detailed, day-to-day processing of management information and are the key source of data for the C2 systems. This section discusses current STAMIS critical to sustainment brigade operations.

### THE STANDARD ARMY RETAIL SUPPLY SYSTEM (SARSS)

3-17. SARSS consists of two interrelated subsystems: SARSS-1 and SARSS-2AC/B. SARSS-1 is the automated system that operates at all SSA to receive, store, and issue supplies directly to the user. SARSS-1 also maintains the accountable records. SARSS-1 has interfaces to receive and process requests for issue from the Unit Level Logistics System (ULLS), PBUSE, and the SAMS. SARSS-2AC (or commonly referred to as the CTASC) is the automated supply management system used by managers at the TSC. It provides the tools for managers to manage stockage levels and support relationships (for example, what units are supported by what SSA for a particular Class of Supply), and establishes operating parameters. CTASC also maintains a custodial availability balance file that provides visibility of SARSS-1 assets to control the lateral issue process of assets between SSAs. It also performs non-time sensitive supply management functions for document history, catalog update, demand analysis, and provides a financial systems interface. The ESC and sustainment brigades have limited CTASC access via secure net terminal on the desktop or laptop personal computer, that enable managers to query into the CTASC. All SARSS-1 boxes communicate directly to the CTASC, not the "fly-away" boxes.

### PROPERTY BOOK UNIT SUPPLY ENHANCED (PBUSE)

3-18. PBUSE is an automated property accountability system that provides online management information and automated reporting procedures for the PBO. It is designed to assist commanders at all echelons in identifying, acquiring, accounting, controlling, storing, and properly disposing of materiel authorized to conduct the unit mission. PBUSE integrates and replaces the functionality of the legacy Standard Property Book System—Redesigned and the Unit Level Logistics System—S4 (ULLS-S4). PBUSE provides users the ability to process transactions for materiel supply classes I, II, limited III (P), IV, VII, and limited IX. It also allows units to perform all the unit property management functions provided for all prescribed organizational and installation assets. It interfaces with SARSS at the forward distribution points to requisition property book and other accountable items required by units. It generates applicable hand receipts/sub-hand receipts and component listings. PBUSE performs automated reporting of assets to support Army TAV.

## STANDARD ARMY MAINTENANCE SYSTEM (SAMS)

3-19. There are three versions of SAMS: SAMS-1, SAMS-2, and SAMS-E which will eventually replace SAMS-1, SAMS-2, and ULLS-G. SAMS-1 is an automated maintenance management system used at the support maintenance company and component repair company found in the sustainment brigades and in the BSB's field maintenance company and FSC. The system automates work order registration and document registers, inventory control and reorder of shop and bench stock, as well as automating work order parts and requisitioning. It produces pre-formatted and ad hoc reports and allows extensive online inquiry.

3-20. SAMS provides the capability for automated processing of field and sustainment maintenance shop production functions, maintenance control work orders, and key supply functions. Requisitions are prepared automatically and an automatic status is received from SARSS-1. It also provides completed work order data to the logistics support activity (LOGSA) for equipment performance and other analyses.

3-21. SAMS-1 automates maintenance documentation and information gathering and transmittal. It also provides the following:

- Management of work orders and work order tasks.
- Allows transfer of repair parts and/or due-ins between work orders and shop stock.
- Accounts for direct, indirect, and nonproductive man-hours.
- Simplifies and standardizes collecting and using maintenance data.

SAMS-1 improves readiness management and visibility by providing equipment status and asset data; raises the quality and accuracy of performance, and lowers cost and backlog through improved maintenance management. SAMS-1 uses commercial off the shelf (COTS) hardware.

3-22. The SAMS-2 is an automated maintenance management system used at the SPO section of the sustainment brigade, CSSBs, and BSB. Field commanders use SAMS-2 to collect and store equipment performance and maintenance operations data. They use this data to determine operator and maintenance guidance to give to their subordinate maintenance units. SAMS-2 also provides the capability of monitoring equipment non-mission capable status and controlling/coordinating maintenance actions and repair parts utilization to maximize equipment availability. SAMS-2 receives and processes maintenance data to meet information requirements of the manager and to fulfill reporting requirements to customers, higher maintenance and readiness managers, and the wholesale maintenance level. Management can access data instantly to control, coordinate, report, analyze, and review maintenance operations. SAMS-2 also:

- Maintains equipment status by line number and unit within the command.
- Maintains a record of critical repair parts and maintenance problem areas.
- Provides visibility of backlog and planned repair requirements.
- Provides maintenance performance and cost evaluation tools.

SAMS-2 provides maintenance and management information to each level of command from the user to the DA level. SAMS-2 collects, stores, and retrieves maintenance information from SAMS-1 sites and allows managers to coordinate maintenance workloads. SAMS-2 passes key maintenance and supply information to higher commands for maintenance engineering and readiness reporting requirements. SAMS-2 operates on COTS hardware.

3-23. SAMS-Enhanced is the replacement system that combines the functionality of SAMS-1, SAMS-2, and ULLS-G. This gives the FSCs, SPOs, and TSC one common operating system that simplifies automation repair and management.

## **TRANSPORTATION COORDINATOR'S AUTOMATED INFORMATION FOR MOVEMENT SYSTEM II (TC-AIMS II)**

3-24. TC-AIMS II is being developed as the Army unit move deployment system. It will replace the legacy system, Transportation Coordinator Automated Command and Control Information System (TC-ACCIS) and provide enhanced functionality. TC-AIMS II, in conjunction with joint force requirements generator II, allows Army units to receive and source time-phased force deployment data received from Joint Operation Planning and Execution System (JOPES). Units will use TC-AIMS II to create and maintain operational equipment lists and unit deployment lists. This information along with the movement information sourced in TC-AIMS II is used to update JOPES through either the computerized movement planning and status system or joint force requirements generator II. The information is also sent to other interface partners such as integrated booking system, WPS, and GATES to allow for the booking and tracking of transportation assets used for deployment. TC-AIMS II also allows units and installations to create military shipping labels (MSL) and radio frequency identification (RFID) tags to allow for ITV of their equipment. It also allows installation transportation offices to create the documentation for unit moves, such as commercial bills of lading and HAZMAT documentation.

## **THE STANDARD ARMY AMMUNITION SYSTEM-MODERNIZED (SAAS-MOD)**

3-25. SAAS-MOD automates retail ammunition management functions in the TSC DMC and sustainment brigade SPO. The system provides ITV and automates receiving, storing, and issuing operations at Army operated TOE/TDA ASAs. SAAS-MOD is a multi-command STAMIS that integrates all retail munitions supply functions and processes. It does this using automated identification technology (AIT) such as RF tags and on desktop type computers in a windows environment. It provides ITV and stock record accounting at the retail level. There are four suites of SAAS-MOD: SAAS-ASP, SAAS-MMC, SAAS-DAO, and SAAS-ATHP. Functions include management of basic load, war reserve, and operational stocks. SAAS-MOD can, either directly or indirectly, provide information to, or receive information from, the following systems:

- SAAS to SAAS.
- LOGSA.
- Worldwide Ammunition Reporting System – New Technology (WARS-NT).
- Property Book Unit Supply Enhanced (PBUSE).
- Army Electronic Product Support (AEPS).
- Transportation Information Systems – Theater Operations (TIS-TO).
- Unit Level Logistics System, Level 4 (ULLS S-4) (until replaced by PBUSE).
- Total Ammunition Management and Information System (TAMIS).
- BCS3.

## **THEATER ARMY MEDICAL MANAGEMENT INFORMATION SYSTEM (TAMMIS)**

3-26. Of the original six subsystems in TAMMIS, an Army legacy medical system, the only module still in use is Medical Supply (MEDSUP). TAMMIS-MEDSUP continues to be the primary Army legacy system for Class VIII inventory management. It provides intermediate-level supply management capabilities for operation of Class VIII SSAs and internal supply operations for hospitals. Intermediate-level supply capabilities include the ability to process orders from external retail-level customers and to manage the materiel release process and facilitate shipping operations to reach distant customers using military or commercial transportation networks. It requires the ability to print DOD standard shipping documents, aggregate materiel shipments by customer, and pass data to external DOD systems for movement planning and ITV. At the retail level, TAMMIS-MEDSUP receives Class VIII requisitions from the TAMMIS customer assistance module (TCAM) on the MC4 hardware platform. The TAMMIS application, as a legacy system, is not a part of the joint Theater Medical Information Program (TMIP-J) family of systems and is only intended as an interim solution until it can be replaced. The proposed replacement for

TAMMIS-MEDSUP is Theater Enterprise-Wide Logistics System (TEWLS) which will ultimately be integrated into DMLSS.

### FINANCIAL MANAGEMENT TACTICAL PLATFORM (FMTP)

3-27. FMTP is a deployable, modular local area network–configured hardware platform that supports finance and resource management operations and functions across the entire spectrum of conflict. System functionality includes vendor services, military pay, disbursing, accounting, travel, and resource management

3-28. The FMTP is designed to use the CAISI for its communications. It also has the ability to function with tactical systems like the signal company’s JNN found within a sustainment brigade or supported BCT. It integrates essential Defense Finance and Accounting System software into a user-friendly package. The system operates on non-developmental item hardware at all levels of the deployed environment, wherever finance units can be found. FMTP is fielded in two configurations: basic and expanded. The basic configuration has six notebook computers, two portable printers, one file server, and one laser printer. The expanded configuration employs 19 notebook computers and two laser printers.

3-29. Systems operating on FMTP include:

- **Deployable Disbursing System (DDS).** DDS is a single disbursing system that supports disbursing operations deployed in tactical environment. DTS provided automated accounting and disbursing documentation to mobile and remote military operations within contingency locations requiring foreign currency operations.
- **Defense Joint Military Pay System (DJMS).** DJMS is the Joint system for pay and entitlements for the Active and Reserve Components.
- **Integrated Automated Travel System (IATS).** IATS is seamless, paperless temporary duty travel system interfacing with accounting, reservation, disbursing, banking, and archiving systems.
- **Commercial Accounts Payable System (CAPS).** CAPS is used to automate manual functions in the accounts payable offices such as:
  - Automatically suspense commercial payments and follow-up letters.
  - Provide payment computations.
  - Produce vouchers and management reports.
  - Compute the payment due date, interest penalties, and determine lost discounts.
  - Allow for entry and processing of purchase rates.
  - Purchase orders/contracts.
  - Determine foreign currency rates.
  - Maintain the Electronic fund transfer information for vendors whose contracts specify this type of payment.
- **The Database Commitment Accounting System (dbCAS).** dbCAS is a commitment ledger system that runs on a stand-alone computer. This system records and manages committed funds and funding data and passes obligations to STANFINS. The dbCAS ledger/user will send commitment data to Split to be forwarded to STANFINS for obligation. The records are obligated, sent back to Split, and returned to the user for updating of commitment/obligation records and status of funds.
- **Paper Check Conversion Over the Counter (PCC OTC).** PCC-OTC converts personal and business checks into electronic funds transfers.
- **Stored Value Card (SVC).** The SVC, also know as the Eagle Cash Card, is a credit card-sized plastic card with an embedded integrated circuit. Typically SVC cards have no value until they are activated and have funds placed on them electronically. Value can be added to cards in a number of ways, including payroll or other financial file transfer, from a credit or debit card, or from cash or checks.

### **DEPLOYED THEATER ACCOUNTABILITY SOFTWARE**

3-30. The Deployed Theater Accountability Software (DTAS) is the cornerstone of accurate accountability of the deployed force. DTAS is a user friendly application that is the sole personnel accountability tool for a deployed unit. This software is designed to report to theater level the personnel accountability information for deployed units. The DTAS System operates on a secure network (for example, secure internet protocol router network [SIPRNET]), but is capable of operating disconnected from the network. There are three distinct levels of DTAS.

### **TACTICAL PERSONNEL SYSTEM**

3-31. The Tactical Personnel System (TPS) is an automated tactical strength management system. It provides the field with an application that can serve as a deployment-manifesting platform for all military personnel, civilians (DOD Federal, non-DOD Federal, Contractors), and Foreign Nationals.

### **DEFENSE CASUALTY INFORMATION PROCESSING SYSTEM-FORWARD**

3-32. Defense Casualty Information Processing System-Forward is an automated system used to record and report casualty data. The system is employed by HR units, typically Casualty Liaison Teams, BDE/BCT S-1 sections, and G-1s performing casualty reporting missions, and is capable of producing automated casualty reports. Defense Casualty Information Processing System-Forward can operate in both the non-secure internet protocol router network (NIPRNET) and SIPRNET modes. Classified casualty reports sent to the theater Casualty Assistance Center may require reentry into an unclassified system prior to forwarding to the Casualty and Mortuary Affairs Operations Center (CMAOC) at Human Resources Command.

### **UNIT LEVEL LOGISTICS SYSTEM – AVIATION (ENHANCED) (ULLS[E])**

3-33. This system provides the capability to automate logistics in all aviation units. It performs the unit level maintenance, Class IX supply, aircraft historical records and readiness reporting functions found in The Army Maintenance Management System-Aviation (TAMMS-A), plus it has been re-designed to take advantage of numerous technological advances in aviation maintenance. ULLS-A(E) leverages new technology featuring: automated aircraft logbook, automated aircraft maintenance, supply chain management, aviator records management, decision support, and ad hoc query and reporting.

### **TRANSPORTATION INFORMATION MANAGEMENT SYSTEM – THEATER OPERATIONS (TIS-TO)**

3-34. TIS-TO (replacement of the Department of the Army Movement Management System) provides an automated information processing capability for planning, programming, coordinating, and controlling movements and transportation resources in a theater of operations. System functions will support multiple sustainment missions in garrison and tactical environments with capabilities to facilitate rapid transition from peacetime to wartime operations. Transportation planners, movement managers, mode operators, trans-shippers, traffic controllers, and unit movement personnel use TIS-TO in an effort to provide a continuous automated flow of accurate and concise transportation information throughout the theater of operations.

3-35. TIS-TO is critical to successfully accomplishing the planning, coordinating, and controlling of movements and transportation resources in a theater of operations. Transportation managers rely on TIS-TO to provide timely and accurate information for import and intra-theater cargo, which can be used to better manage available fleet assets. The system uses a Department of Defense Activity Address Code database that provides up-to-date customer addresses and point of contact information used by movements control organizations as well as military mode operators to aid with timely pick-up and delivery of personnel and materiel in the deployment and distribution system. By taking advantage of Citrix technology, transportation managers in other regions of the theater of operations are able to receive near real time information for movements coming into or leaving their AOs.

3-36. TIS-TO is composed of the following three modules and one interface providing the prime functionality used to manage military movements in a theater of operations:

- **Theater Address System (TAS)** – TAS provides a central repository of addressing and related information on shippers, receivers, and carriers. Because of this, it is normally contained at the highest level of transportation command or agency within the theater of operations. New and revised address information that is received from other TIS-TO sites is validated, processed, and automatically redistributed. This module is also used to maintain and distribute theater-unique code tables.
- **Shipment Management Module (SMM)** – SMM provides both shipment visibility and controlled movements capabilities. Within shipment visibility, is the capability to receive and process import ocean cargo data, forecast shipment delivery, and maintain voyage information. The controlled move capability enables the user to process trace, hold, divert, expedite, and re-consign requests and responses. The controlled move capability can also record specified cargo movement events, record and report controlled move transactions, and process query requests and responses. It provides the automated capability to forecast the arrival of inter-theater cargo and containerized shipments. This module also maintains visibility of inter-theater command-interest cargo as well as import cargo arriving and departing from water ports of debarkation to the customer. SMM also produces management reports that can be transmitted to transportation controllers throughout the theater of operations.
- **Movement Control Team (MCT)** – MCT provides automated capability to coordinate transportation services for shippers, carriers, and receiving activities. The functionality includes the capability to record and task movement requirements, monitor, and control container movements, monitors inter-modal asset flow, and process shipment trace, hold, divert, expedite, and re-consign requests. The module is used to create a movement release based on requirements. Transaction files are automatically created for the responsible military mode operators and the destination MCTs. Other functionality includes the capability to receive and process container forecasts, report container status, and capture movement-related costs. Movement status is provided to the SMM module, which can be furnished to external movement C2 systems contributing to ITV.
- **Worldwide Port System (WPS) Interface** - TIS-TO receives advanced ocean cargo manifest data from WPS at the port of embarkation (POE) by means of File Transfer Protocol (FTP) prior to a vessel's arrival at a water port of debarkation (WPOD). Arriving cargo information is then formatted into a report, sorted by consignee and forecasted to the appropriate supply or materiel management center. Once cargo arrives at a WPOD, TIS-TO is notified again that the vessel has been discharged or if the port needs mode assets to move the cargo to the consignee. The movement record is updated one final time when the cargo departs the port and is delivered to the consignee.

## JOINT SYSTEMS

3-37. Joint automation systems provide technological interoperability across the Services. Systems like TC-AIMS II, and MC4 (the Army component of the joint system) provide the military integrated data management and mutual functionalities for common services like transportation and healthcare.

### MEDICAL COMMUNICATIONS FOR COMBAT CASUALTY CARE (MC4) SYSTEM

3-38. MC4 is the Army's medical information system. As the Army component of the Joint Theater Medical Information Program (TMIP), MC4 will provide the hardware infrastructure for the TMIP medical functionality software, as well as software required to ensure MC4/TMIP interoperability with Army C2 and sustainment systems and provide reach to the sustaining base. The MC4/TMIP systems will rely on Army communications systems for transmission of health care information.



3-39. The TMIP software will enable the following medical functionalities:

- Electronic medical record.
- Medical surveillance.
- Patient tracking.
- Blood management.
- Medical logistics support.
- Medical reporting.

3-40. The primary TMIP software application to document health care information is Armed Forces Health Longitudinal Technology Application Theater (AHLTA-T). Armed Forces Health Longitudinal Technology Application-Mobile (AHLTA-M) will be used by combat medics and certain health care providers at health care Role 3 to initiate documentation of health care information. Health care information documented will be contained in the electronic medical record for each Soldier. The Joint Medical Work Station (JMeWS) will provide C2 and health surveillance information and will be the source of various medical reports. Using spiral development, the TMIP acquisition strategy includes incremental releases that will improve upon existing systems or add new capabilities. The Class VIII inventory management system is presented in a previous paragraph in this document.

3-41. The direct users of the MC4/TMIP systems will be all tactical Army medical personnel who support the following Force Health Protection functional areas:

- Medical C2.
- Forward casualty resuscitation and treatment.
- Hospitalization.
- Medical logistics and blood management.
- Preventive medicine.
- Veterinary and food inspection.
- Laboratory support.
- Dental health.
- Medical evacuation.
- Combat and operational stress control support.

3-42. The MC4 system must be interoperable with Army Battle Command Systems, such as GCCS-A and BCS3, in order to provide critical medical information for warfighting situational awareness and assist in planning and decision making. The MC4/TMIP systems will also be interoperable with sustaining base knowledge center systems, such as Center for Disease Control and Prevention and the Center for Health Protection and Preventive Medicine.

## **TECHNOLOGIES**

3-43. Advances in science and technology provide logisticians with capabilities that enhance or complement existing automation systems. The following paragraphs describe some of tools that help sustainment brigade planners and executors better perform their wartime functions by expanding or strengthening the capabilities of C2 automation systems or STAMIS.

### **RADIO FREQUENCY IDENTIFICATION (RFID)**

3-44. RFID when linked to a network of interrogators provide logisticians a means to remotely identify, categorize, and locate materiel in the distribution system. Remote interrogators electronically read the tags and send location/status data to an ITV server.

3-45. RFID is a generic name given to devices used to provide timely and accurate information on the location, movement, status, and identity of units, personnel, equipment, and supplies to users via radio frequency technology.

- It encompasses a range of wireless devices that send, receive, and store data.
- The technology employs electronic readers known as "interrogators" that send or receive radio wave signals to/from compact storage modules called "RF tags."
- Interrogators may be either fixed or handheld.
- Docking stations, handheld devices, or interrogators may be used to write data to tags.

3-46. A wide range of tags are available for mounting on products and assets. The type and design of RFID tags are selected according to customer requirements. The right selection of RFID tags enables high speed automatic scanning of products and assets equipped with an RFID tag. Among the tag types available are active tags, semi-active, and passive.

3-47. The data placed on the RFID tag is written from automated information systems such as Transportation Coordinator's-Automated Information for Movements System Version II (TC-AIMS II), TC-ACCIS, SARSS, Standard Army Ammunition System-Modernization (SAAS-MOD) which are normally loaded on the same computer as the tag writing software.

### **AUTOMATIC IDENTIFICATION TECHNOLOGY (AIT)**

3-48. AIT is not a system or a single product, but a family of commercial technologies that provides a spectrum of enabling capabilities into DOD information systems. It includes, but is not limited to, bar coding, RFID, integrated circuit cards or "smart cards," memory buttons, magnetic stripe, and optical memory cards. AIT introduces information system efficiencies using enabling technology and standards, providing interoperability not only across DOD, but also with our Coalition and commercial business partners, ensuring a seamless flow of data pertaining to goods in the supply chain.

### **IN-TRANSIT VISIBILITY (ITV)**

3-49. ITV provides real-time data to collaboratively plan and prioritize logistics operations, the capability to track and redirect your unit's equipment and supplies that are en route, and "inside-the-box" visibility of shipments.

3-50. RF tags supply the en route reporting that is required to have ITV, but there are other AIT devices that are also important in gathering the data required to provide ITV.

- Bar Codes: The linear bar code provides item identification and document control information for individual items and shipments by document number.
- 2-D Bar Codes and Military Shipping Labels (MSLs): 2D bar codes and MSLs are used when the individual items or the items that make up the document number are consolidated into a larger container (for example, a tri-wall box). They identify the contents of the box or another type of container where individual items are consolidated.

### **EMERGING SYSTEMS**

3-51. The Army is working on a number of systems and methods to support force projection operations in the near-term and beyond. Commanders and logistics' managers at various levels of the Army need access to these systems and their products in order to effectively manage distribution and the movement and sustainment of the force.

### **GLOBAL COMBAT SUPPORT SYSTEM-ARMY (GCSS-ARMY)**

3-52. Global Combat Support System-Army (Field/Tactical) (GCSS-Army (F/T)) is the replacement for several of the Army's current STAMIS. It will operate in conjunction with other key systems (such as BCS3). It provides support personnel detailed information about support required by the warfighter and the current availability of needed materiel, to include items in the distribution system. GCSS-Army F/T will

address the Army's current automation dilemma of having stove-piped systems, that is, systems that do not share information horizontally among different functional areas. It will employ state-of-the-art technology to include client-server technology designed to take full advantage of modern communications protocols and procedures. It will be designed with the maximum amount of communications capability and flexibility so that it can take advantage of any available communication systems to include commercial or military, terrestrial or space-based. GCSS-Army F/T will comply with the defense information infrastructure (DII)/common operating environment technical and data element standards. Compliance with these DOD-level standards is a critical step toward achieving the required joint interoperability to support the DOD GCSS.

### **DEFENSE INTEGRATED MILITARY HUMAN RESOURCES SYSTEM (DIMHRS)**

3-53. DIMHRS is an internet based single, integrated military personnel and pay management system for all DOD military Services and components during peace and wartime, including mobilization and demobilization. DIMHRS will provide the following functions:

- Common DOD data definitions, business rules, and functionality in most instances including Service-unique and component-unique features where necessary at both the HQ and field levels.
- A record for each individual that contains personnel and pay data and includes historical records of service in all components (true integration of AC/RC).
- A single entry of data with specified standards for timeliness, accuracy, security, and interoperability.
- Accountability of all personnel assets. This includes capturing and maintaining accurate and timely personnel data in theaters of operation and at home bases.
- Empower human resource managers through automated workflow processes for personnel and pay with policies embedded in automated business rules.
- Provide Soldiers with convenience and improved customer service throughout their career life cycle.

## **SECTION III - COMMUNICATIONS**

3-54. The sustainment brigade passes information quickly and accurately to the TSC/ASCC, subordinates organizations, and units located in or passing through its support areas. The following paragraphs discuss the functions of the S-6 staff section and C2 planning, as well as the use of subscriber devices, radio nets, and contingency satellite communications in the sustainment brigade.

### **S-6 STAFF SECTION**

3-55. The sustainment brigade S-6 is the principal staff officer for all matters concerning communications operations. The S-6 section is organized to support the commanders' intent. The S-6 and staff plan the communications and information systems support for the brigade, brigade command posts, and assigned subordinate units.

3-56. The S-6 section personnel are located within the brigade command posts to support the commander's communications requirements across the AO. The S-6 works closely with the Brigade Signal Company/Network Support Detachment (Brigade Signal Company/NSD) commanders. The brigade S-6 exercises technical oversight of all signal elements.

## **BRIGADE S-6 STAFF RESPONSIBILITIES**

3-57. The brigade S-6 staff responsibilities include:

- Prepare, maintain, and update command, control, communications, and computer operations, operations estimates, plans, and orders. Orders will often cause configuration management changes across multiple battalions.
- Monitors and makes recommendations on all technical communications operations.
- Advises the commander, staff, and subordinate commanders on communications operations and network priorities.
- Develop, produce, change/update, and distribute signal operating instructions.
- Prepare/publish communications operations SOPs for command posts.
- Coordinate, plan, and manage electro-magnetic spectrum within its AOR.
- Plan and coordinate with higher and lower HQ regarding information systems upgrade, replacement, elimination, and integration.
- In coordination with the S-2 and S-3, coordinates, plans, and directs all information architecture activities and communications operations vulnerability and risk assessments.
- In coordination with the staff, actively coordinates with a variety of external agencies to develop the information and communications plans, manage the information network, obtain required services, and support mission requirements.
- Confirms and validates user information requirements in direct response to the mission.
- Establishes communications policies and procedures for the use and management of information tools and resources.

## **BRIGADE SIGNAL COMPANY**

3-58. The Brigade Signal Company may be assigned or attached to the sustainment brigade STB. The Brigade Signal Company has a HQ and range extension platoon. When assigned to the STB, the Brigade Signal Company provides line of sight (LOS) and beyond-line-of-sight (BLOS) connectivity. It is capable of direct standardized tactical entry point interface when required. The net support platoon provides wireless network extension for the single channel ground and airborne radio system (SINCGARS) and enhanced position location and reporting system (EPLRS). There is an embedded communications and electronics maintenance section that accepts turn-ins and provides replacement of components.

### **HEADQUARTERS AND RANGE EXTENSION PLATOON**

3-59. The Brigade Signal Company headquarters and range extension platoon within the sustainment brigade consist of the company headquarters, signal maintenance team, NETOPS team, small command post (CP) support team(s), and retransmission team(s). The range extension platoon has additional range extension assets to support the large operating area of the sustainment brigades.

### **COMPANY HEADQUARTERS**

3-60. The company headquarters within the Brigade Signal Company provides C2, logistics, and administrative support for the company/detachment.

### **Signal Maintenance Team**

3-61. The signal maintenance section the Brigade Signal Company performs field level maintenance on special organic network equipment, such as the joint network node (JNN) suite of equipment. This section also facilitates troubleshooting of all other communication-electronic (C-E) equipment in the company and manages the company's communications-electronics Combat spares. The C-E maintenance team evacuates equipment that cannot be repaired at the unit level to the brigade's sustainment battalion contact team. If

further maintenance is needed, the equipment will either be supported by contract maintenance, COTS replacements, or depot level rebuild.

### **NETOPS Team**

3-62. The NETOPS teams within the Brigade Signal Company provide company level specific NETOPS support. The team works closely with the NETOPS personnel within the brigade S-6 section.

### **Small CP Team(s)**

3-63. The small CP support team of the Brigade Signal Company provides BLOS connectivity and tactical Local Area Network (LAN) support to the brigade CP and other C2 nodes.

### **Network Extension Platoon**

3-64. The network extension platoon consists of the JNN and extension sections and is designed to support a major C2 node. The Brigade Signal Company network extension platoon support requires one network extension platoon. The Brigade Signal Company assigned/attached to the sustainment brigade has additional range extension assets to support the large operating area of the sustainment brigade.

- The JNN section provides voice, video, and data services. It provides habitual BLOS and LOS support. The JNN has the ability to terminate circuits, provide data and battlefield video-teleconferencing center connectivity to host equipment, and interface special circuits; such as DSN, NATO circuits, and commercial gateways.
- The extension section provides frequency modulation retransmission, EPLRS network management, and an EPLRS gateway team for the assigned CP.

## **COMMUNICATIONS SUPPORT PLAN**

3-65. When preparing for projected operations, the S-6 prepares or revises existing communications estimates. During the preparation of the communications annex to the TSC operation plan/operation order (OPLAN/OPORD), the S-6:

- Analyzes the communications requirements of the HQ and units for projected operations.
- Determines the extent of communications support required.
- Recommends to the S-3 locations for command posts based on the information environment.
- In conjunction with the S-2 and S-3, plans office performs communications systems vulnerability and risk management.
- Determines the sources and availability of communications assets.
- Coordinates with the TSC G-6 on the availability of HN commercial information systems and services for military use.
- Develops plans to provide the HQ with continuous communications from the time of alert through establishing operations in the AO.
- Recommends essential elements of friendly information for communications.
- Supports CSSAMO with sustainment of non-secure communications operations such as STAMIS and related systems.
- Ensures that redundant communications means are planned and available to pass time-sensitive critical information.
- Coordinates, plans, and directs all information architecture activities conducted within the command.
- Requests and receives, as necessary, assistance from the TSC.

## HOST NATION INTERFACE

3-66. HN commercial telephone service can supplement tactical communications systems. To reduce the burden on tactical communications systems, sustainment brigade units use the commercial phone system when it is feasible to do so without compromising operations.

3-67. Where HN support agreements exist, the sustainment brigade command net and DMC net may interface with supporting HN organizations. Communications between the HN and the sustainment brigade occur via fixed and field-type communications links. To ensure interoperability with HN supporting units, the sustainment brigade needs communications and automation equipment that allows them to interface with the communications network of supporting HN organizations. Using existing HN telephone lines enable communications with US liaison teams.

3-68. Standardization agreement (STANAG) 4214 covers digital interoperability with North Atlantic Treaty Organization (NATO) units. STANAG 5000 covers facsimile AN/UXC-10 interoperability capabilities.

## RADIO NETS

3-69. S-6 section personnel analyze the types of radio net requirements discussed below and arrange for installation as required by operations. As with wire communications, radio nets support both the internal and external operations of the brigade.

### HIGH FREQUENCY (HF) NET

3-70. Support operations section personnel may use the HF radio command operations net to coordinate supportability issues with TSC HQ and subordinate commands. The HF command net enables the brigade staff to discuss critical support issues with the TSC control centers. The HF command net enables brigade staff to obtain real-time information and to maintain communications when relocating the CP.

3-71. The brigade HF command net enables the command section staff and support operations staff officers to disseminate mission tasking and transmit critical requirements data with the TSC, subordinate units, and control centers.

### FREQUENCY MODULATION (FM) NET

3-72. The FM net enables sustainment brigade HQ and subordinate functional centers and commands to react quickly to changes in OPLANs and support requirements and to direct/redirect subordinate units. It provides a means to transmit daily support data and it supports inter-staff coordination. The FM net allows support operations staff officers to confer with staff counterparts in subordinate organizations.

3-73. The brigade support operations staff officers use the FM net to direct support efforts of subordinate organizations and coordinate efforts with other sustainment commands and units. The FM command net also allows support operations staff to transmit critical or time-sensitive information on the status of units and supportability of specific operations.

### SECURITY OPERATIONS NET

3-74. Organic short-range FM radios are also authorized to facilitate transmitting operational data. They allow the brigade HQ to coordinate with the TSC, response forces, and other units in the brigade's AO.

3-75. The STB commander and HQ company commander use their FM radios for base security and to communicate with other base elements. This net allows base and base cluster elements to report incidents and request support.

## **MOVEMENT TRACKING SYSTEM (MTS)**

3-76. MTS provides commanders and their vehicle operators the capability to track vehicles and communicate while on and off the road nearly anywhere. There are two main components to the system: a mobile unit mounted on a unit's vehicles and a control station, which monitors a vehicle's location. Both components use the same basic communications software and hardware, although the control station uses a computer with a larger display and faster processor. Communications between the two is provided by a commercial satellite vendor that allows units to send and receive traffic over the horizon, anytime, anywhere.

3-77. MTS incorporates digital maps in the vehicles and allows two-way satellite text messaging thereby allowing the transportation coordinator the ability to 'talk' to the driver of any truck, regardless of location, without having to put up antennas or involve more Soldiers. The MTS is adaptable to future incorporation of radio frequency technology, automatic reporting of vehicle diagnostics, and other features that support in transit visibility.

## **CONTINGENCY SATELLITE COMMUNICATIONS**

3-78. Satellite-based communications systems integral to the sustainment brigade's mission. They must be configured with single-entry data points that handle multiple users and purposes. They cannot be limited by geography or distance. The signal command supporting the theater provides tactical satellite (TACSAT) support to the sustainment brigade during contingency operations missions. TACSAT provides the brigade with standard secure voice or data and analog or digital capability that is compatible with other operational level HQ in the AO. A contingency package from the Expeditionary Signal Battalion (ESB) may be in the form of a CPN, JNN, or SSS terminal depending on the communications support required.

3-79. Though TACSAT provides the communication link, planners consider the following:

- The limited availability of TACSAT terminals.
- Possible long lead-time for satellite access requests (SAR). If the HQ moves, early completion of the SAR improves the chances of getting the request approved and back in a timely manner.
- Preemption by higher priority users. In rare instances, users with higher priority cause the antenna used by the TACSAT terminal to switch to another user. While these instances are rare, they do happen and system administrators give users plenty of warning to seek other means of communications.
- Data rate constraints for satellite communications. Not all TACSAT terminals can provide the higher data required by the subscribers. Planners should take care to place the most critical circuits on the TACSAT and use other means for less important communications.
- The effect of weather on satellite communications.
- Limited electronic warfare survivability.
- Possible gaps in service when acquiring connections to satellites.

## **COMBAT SERVICE SUPPORT AUTOMATED INFORMATION SYSTEMS INTERFACE (CAISI)**

3-80. CAISI will accept information from automation devices interfacing over military communication networks (for example, CSS satellite communications, MC4, Defense Data Network, Defense Switching Network, VSAT, US public switched networks, and commercial communications systems of nations with which the US has defense agreements). It provides connectivity for network capable STAMIS through a 12 port 10Base2 multi-port wireless device module. Each port can support up to 24 users. However, the low density of network capable systems should permit each STAMIS to be assigned to a separate port. This lets a user connect or disconnect from CAISI without causing disruptions to other users. CAISI connects to an Inline Encryption Device and communicates over the CSS satellite communications to route traffic to distant CAISIs and hosts. The three CAISI components are: Bridge module (CBM), Client module (CCM), and a System Support Representative (SSR). It is a high data rate, sensitive but unclassified wireless LAN.

3-81. Features: Client module: connect up to 7 computers to wan; CBM: connect up to 14 computers to wide area network (WAN); radio relay; display switch locator routing backup; connect to Army common

user/commercial communications; system support laptop with component configuration software router with NAT and Dynamic Host Configuration Protocol (DHCP) capability; the SSR provides: laptop with component configuration software router with national DHCP protocol for automating the configuration of computers that use traffic control post/IP capability; a CAISI fielding may currently include a maximum of 7 computer users per CCM, 14 per CBM, and as many as 8 CCMs to CBM bridge connections without degrading RF at the central root node; 1 CBM is designated at each unit as the central/root node; this node controls the LAN parameters and traffic for that service area; the root node can link a CAISI LAN to a neighboring CBM to expand the network; any CBM may link to a VSAT, MSE, JNN, or brigade Subscriber Node in order to access TPN and other wider reaching protocols such as the NIPRNET and limited voice over internet protocol (VOIP) communications; the CCM may also be and is more commonly connected directly to a CSS VSAT.

### **VSAT (VERY SMALL APERTURE TERMINALS)**

3-82. VSAT provides forward deployed sustainment units a communication capability for logistics systems or STAMIS that is substantially the same as in the garrison environment. VSAT connects sustainment elements across the globe. VSAT are small, software-driven earth stations used for the reliable transmission of data or voice via satellite. It requires no staff or additional technology to operate it. It simply plugs into existing terminal equipment. VSAT satellite communications provide virtually error-free digital data communications and better than 99.9 percent network reliability. VSAT services are delivered through the use of KU-Band geostationary satellites. VSAT uses a star network with the use of satellite earth stations that rely on a large central hub. They can be configured in both one-way (receive only) and two-way (interactive) VSAT terminals.



## Chapter 4

# SUPPORT TO THE OPERATING FORCES

In full spectrum operations, every unit—regardless of type—either generates or maintains combat power. Generating and maintaining combat power throughout an operation is essential to success. Commanders must have a thorough understanding of the sustainment warfighting function and the sustainment assets available in order to properly stage those assets in a way that preserves momentum. This chapter discusses the sustainment warfighting function and subfunctions and describes the elements within the sustainment brigade that perform the functions. The intent is to provide an understanding of what must be done and what assets are available to provide support to the operating forces. See FM 3-0 for more information on warfighting functions.

### SECTION I – OVERVIEW

#### SUSTAINMENT WARFIGHTING FUNCTION

4-1. The Sustainment warfighting function is comprised of the related tasks and systems that provide support and services to ensure freedom of action, extend operational reach, and prolong endurance. The endurance of Army forces is primarily a function of their sustainment. Sustainment determines the depth to which Army forces can conduct operations. It is essential to retaining and exploiting the initiative. Sustainment is the provision of the logistics, personnel services, and health service support necessary to maintain operations until mission accomplishment. Health services support and force health protection are both mission areas of the Army Health System. While health services support is a subfunction of the sustainment warfighting function, force health protection is a subfunction of the protection warfighting function.

#### LOGISTICS SUB-FUNCTION

4-2. Logistics is the science of planning, preparing, executing, and assessing the movement and maintenance of forces. In its broadest sense, logistics includes the design, development, acquisition, fielding, and maintenance of equipment and systems. Logistics integrates strategic, operational, and tactical support of deployed forces while scheduling the mobilization and deployment of additional forces and materiel. Logistics includes—

- Maintenance.
- Supply.
- Field services.
- Transportation.
- General engineering support.

### **PERSONNEL SERVICES SUB-FUNCTION**

4-3. Personnel services are those sustainment functions related to Soldiers' welfare, readiness, and quality of life. Personnel services complement logistics by planning for and coordinating efforts that provide and sustain personnel. Personnel services include—

- Human resources support.
- Financial management.
- Legal support.
- Religious support.
- Band support.

### **HEALTH SERVICE SUPPORT SUB-FUNCTION**

4-4. Health service support consists of all support and services performed, provided, and arranged by the Army Medical Department. It promotes, improves, conserves, or restores the mental and physical well being of Soldiers and, as directed, other personnel. This includes casualty care, which involves all Army Medical Department functions, including—

- Organic and area medical support.
- Hospitalization.
- Dental care.
- Behavioral health and neuropsychiatric treatment.
- Clinical laboratory services and treatment of chemical, biological, radiological, and nuclear patients.
- Medical evacuation.
- Medical logistics.

### **SUPPORT OPERATIONS UNDER CENTRALIZED LOG C2**

4-5. The design of the Theater Sustainment Command reduces command layers once present in the AOE logistics organizational hierarchy and integrates the other major subfunctions of the Sustainment Warfighting Function -- Personnel Services and Health Service Support. The realignment of support functions enables centralized control and decentralized execution of sustainment operations in accordance with the commander's priorities and intent. The TSC is the proponent for theater distribution and is responsible for theater RSO, movement, sustainment, and redeployment functions in support of Army forces (all of which include the subfunctions of sustainment). It is also responsible for establishing and synchronizing the intra-theater segment of the distribution system with the strategic-to-theater segment of the global distribution network.

4-6. The TSC, ESC, and sustainment brigade SPO translates the commander's operational priorities into priorities of support. The SPO prepares concept of support annexes to the OPLAN/OPORD and balances capabilities with requirements. The SPO coordinates, develops, and monitors the preparation and execution of plans, policies, procedures, and programs for external and area support. The TSC SPO monitors theater stocks, personnel, financial management, and the integration of aviation asset requirements into the overall support plan. The SPO is also responsible for coordinating movements and throughput of personnel, supplies, and equipment.

4-7. The sustainment brigade SPO's materiel management effort is focused on the management of its supply support activities (SSA) in accordance with TSC plans, programs, policies, and directives. The sustainment brigade SPO coordinates and controls supply functions to meet the operational requirements of its supported units in accordance with TSC guidelines; employing near real-time situational awareness of stock records and asset visibility to provide responsive and agile support. Analysis of stock status and mission requirements enables the sustainment brigade SPO section to effectively manage its work load and control potential backlogs or bottlenecks generated by competing requirements and/or priorities. The

sustainment brigade SPO, when directed by the TSC, can manage the manager review file (MRF) and perform Routing Identifier Code-Geographic (RIC-GEO) management for units in its AO.

**ORGANIZATIONAL OPTIONS**

4-8. The sustainment brigade is designed to be a flexible organization that is task organized to meet mission requirements. The sustainment brigade has a command and staff structure capable of providing the full range of sustainment to the operational or the tactical level. It does not have the organic capacity to execute its assigned mission without the assignment of subordinate support units. The sustainment brigade is augmented by a number of different types of tailored organizations. The types and numbers of these organizations depend on the mission and the number, size, and type of organizations the sustainment brigade must support. Figure 4-1 shows the organization of a notional sustainment brigade task organized for support operations.

4-9. The rest of this chapter covers some of the considerations and options for task organizing the sustainment brigade’s CSSBs and subordinate units in an AO. It also provides an overview of some of the units that might be found in attached CSSBs.

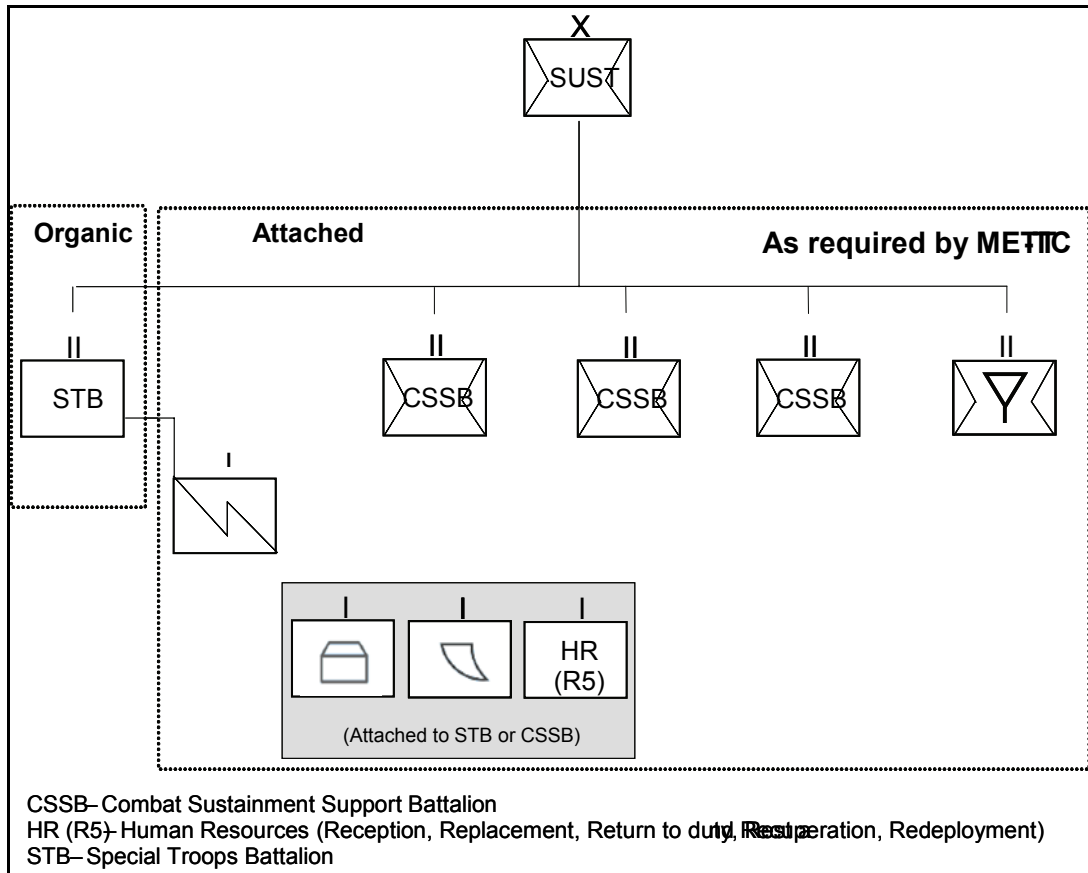

**Figure 4-1. Notional Sustainment Brigade**

**SECTION II – COMBAT SUSTAINMENT SUPPORT BATTALION (CSSB)**

4-10. CSSB is a tailored, multifunctional logistics organization. It is a flexible and responsive team that executes logistics throughout the depth of their assigned AO. The CSSB subordinate elements may consist of functional companies providing supplies, ammunition, fuel, water, transportation, cargo transfer, MA, maintenance, field services, and HR management. This framework enables the employment of a tailored

logistics unit capable of adapting quickly to changing tactical conditions. The CSSB works through the sustainment brigade in concert with the TSC for logistics operations to effectively support the maneuver commander.

4-11. Three to seven total subordinate battalions may be attached to a single sustainment brigade depending on the brigade’s mission. The CSSB is under the C2 of the sustainment brigade commander. It is the base organization from which force packages are tailored for each operation. Through task organization, the CSSB is capable of providing support during all phases of operations. The CSSB is structured to optimize the use of resources through situational understanding and common operational picture (COP). The mission of the CSSB is to C2 organic and attached units; provide training and readiness oversight; and provide technical advice, equipment recovery, and mobilization assistance to supported units. The headquarters detachment provides unit administration and sustainment support to the battalion staff sections. Figure 4-2 shows an organizational chart for the CSSB.

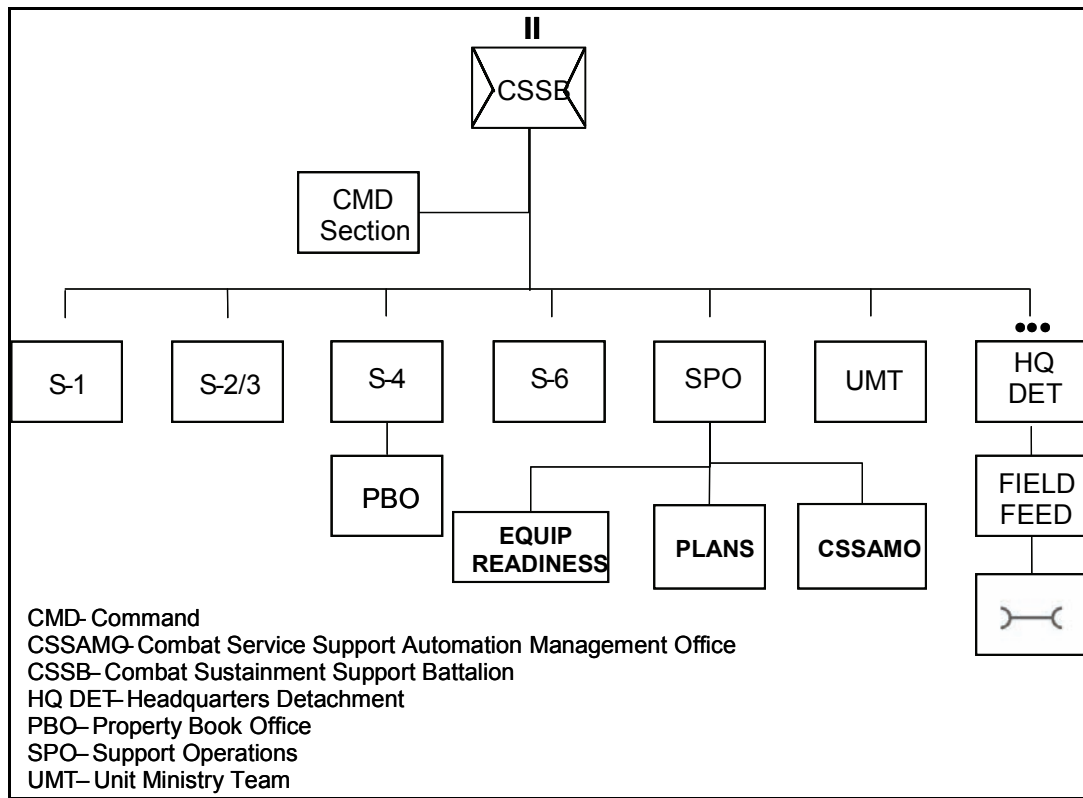

Figure 4-2. The CSSB Headquarters

### CSSB Subordinate Organization Functions

4-12. Supported units are reliant upon CSSBs to meet replenishment requirements beyond their internal capabilities. The CSSB is the entity of the sustainment brigade that provides the distribution link between theater base, APOD(s), SPODs, and the supported units. The structure includes cargo transfer and movement control assets, fused with supply functions. The CSSB also performs the function of transporting commodities to and from the BSB of the maneuver BCT and to and from theater repair or storage facilities. Its function is to maintain the flow of replenishment; to retrograde unserviceable components, end items, and supplies; to monitor the distribution of replenishment that is throughput directly from the theater base by assets of the sustainment brigade tasked with providing theater distribution; and to assist with coordination and delivery if necessary. The CSSB augments/supplements supported units during the normal replenishment cycle, delivering supplies that are not being throughput

directly to units. A brief discussion of some of the CSSBs functions follows. More in-depth information on the subordinate units that provide these functions can be found later in this chapter.

### ***Ammunition***

4-13. Ammunition elements assigned to the CSSB provide for the receipt, storage, issue, and reconfiguration of ammunition items. These elements provide flexibility and can be tailored in order to support the full spectrum of operations. Ammunition platoons can be attached as needed to meet surge requirements. Bulk Class V is received at the SPOD where ammunition elements of the TSC configure unit loads of Class V within its ASA. The ammunition is then throughput directly to using units, to CRSPs, or to the ASA, and ammunition transfer and holding points (ATHP) for distribution to supported units as required.

### ***Transportation***

4-14. Transportation assets of the CSSB provide mobility of personnel and all classes of supplies. When the CSSB is assigned to a sustainment brigade tasked to provide theater distribution, it will be heavily weighted with transportation assets. At the operational level, the CSSBs transportation assets will normally operate between the operational and the tactical levels. However, loads can be throughput from the strategic level direct to the tactical level (for example, BSB) based on METT-TC. At the tactical level, the CSSBs transportation assets will provide mobility from the CSSB base to the BSB and the FSCs within the BCT area.

### ***Maintenance***

4-15. Maintenance assets of the CSSB provide maintenance based on the two-level (field and sustainment) maintenance characteristics. The CSSB normally provides field maintenance support to the task force. Field maintenance is provided on an area basis. CSSB maintenance elements are designed with the capability to send slice elements forward to support a maintenance surge or to help clear maintenance backlogs at the BSBs and FSCs. Deployed CRCs and field repair activities remain under the C2 of the AFSB, but may collocate with a CSSB to provide sustainment maintenance support. Medical equipment maintenance, calibrations, and verification/certification in the sustainment brigade will be provided by medical equipment repairers from the supporting Medical Logistics Company (MLC).

### ***Supply and Services***

4-16. Supply and Services (S&S) assets of the CSSB provide all classes of supplies (less Class VIII) and quality of life operations for personnel operating in or transiting the AO. Supply involves acquiring, managing, receiving, storing, and issuing all classes of supply (less Class VIII). The CSSB provides field services such as laundry, shower, light textile repair, MA, and aerial delivery support. The CSSB may also provide billeting, food services, and sanitation when conducting base camp operations.

### ***Human Resources and Financial Management***

4-17. An organizational option is to attach the HR and FM companies as depicted in Chapter 2 to the CSSB instead of the STB of the sustainment brigade as discussed in Chapter 2.

## **COMMAND GROUP**

4-18. The CSSB has a command group and staff that is the same as any other battalion and performs the same functions as in the sustainment discussed in Chapter 2.

## **SECTION III – LOGISTICS SUBFUNCTION**

4-19. The purpose of this section is to describe how key logistics functions will be performed by the sustainment brigade. In addition to providing descriptions of the logistics functions performed by the sustainment brigade, this section will identify many of the units that execute these functions. Logistics

reporting (formerly called LOGSTAT) supports all the other functions within this chapter and is critical for C2 and situational awareness of unit status for both combat HQ and also supporting units. It is critical to the timeliness and accuracy of replenishment of all classes of supply. Logistics reporting is discussed further discussed in Appendix C, including a proposed standard report.

## MAINTENANCE

4-20. The overarching principle of replace forward/fix rear remains unchanged. Tailorable organizations execute the two-level maintenance system, composed of field maintenance and sustainment maintenance. Field maintenance involves platform tasks normally done by assets internal to the owning organization that return systems to a mission capable status. At field maintenance level, all functions are focused on replacing damaged components and returning the repaired item to the user. The desired end state is to reduce repair cycle times by providing capabilities as far forward as possible, maximizing reliance on parts distribution, stock visibility, and component replacement. Sustainment maintenance involves platform tasks that are done primarily in support of the supply system (repair and return to supply), and will not normally be performed inside the brigade/BCT AO. There are no fixed repair time guidelines for performing field or sustainment repair. In the current Army, maintenance procedures and doctrinal methods are changed to gain greater effectiveness and efficiencies.

4-21. The Army maintenance system employs tailorable field level maintenance units called support maintenance companies (SMCs). Sustainment level maintenance units called component repair companies (CRCs) are sent forward in the CSSB of the sustainment brigade. Each type of maintenance organization is built from a company HQ that can accept platoon and team level elements. These organizations are also capable of having 10 percent of their structure composed of contractors or DA/DOD civilians.

### SUPPORT MAINTENANCE COMPANY (SMC)

4-22. The SMC (see Figure 4-3) provides area support to units in the sustainment brigade AO.

- Provides support field maintenance.
- Supports theater opening packages (Army pre-positioned stocks).
- The SMC is capable of accepting modules ( platoons/sections/teams) from CRCs and C&Cs.

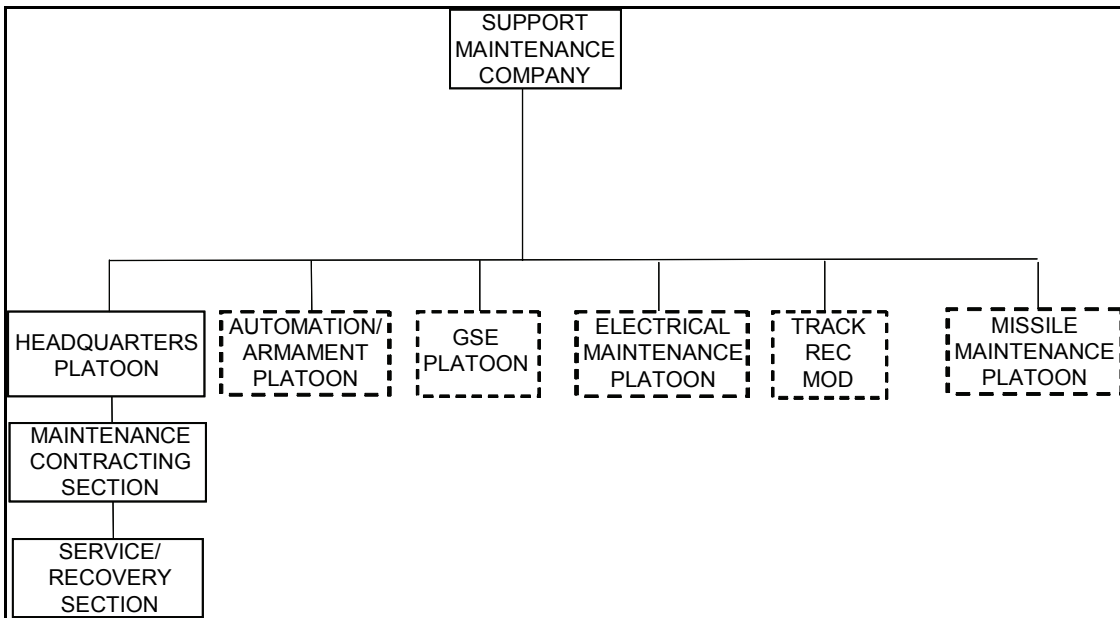

Figure 4-3. Support Maintenance Company

## COMPONENT REPAIR COMPANY (CRC)

4-23. The CRC (see Figure 4-4) provides repair and return to the theater supply system. CRCs are employed in the distribution system beginning at the national source of repair. These units can be pushed forward at the direction of the AFSB into the AO only as needed and will be workloaded by the AFSB. These units:

- Provide repair and return to the supply system.
- Operate in conjunction with a supply support activity (SSA).
- Can attach platoons/sections/teams to SMC or other sustainment units.
- Integrated maintenance repair activities with AFSB.

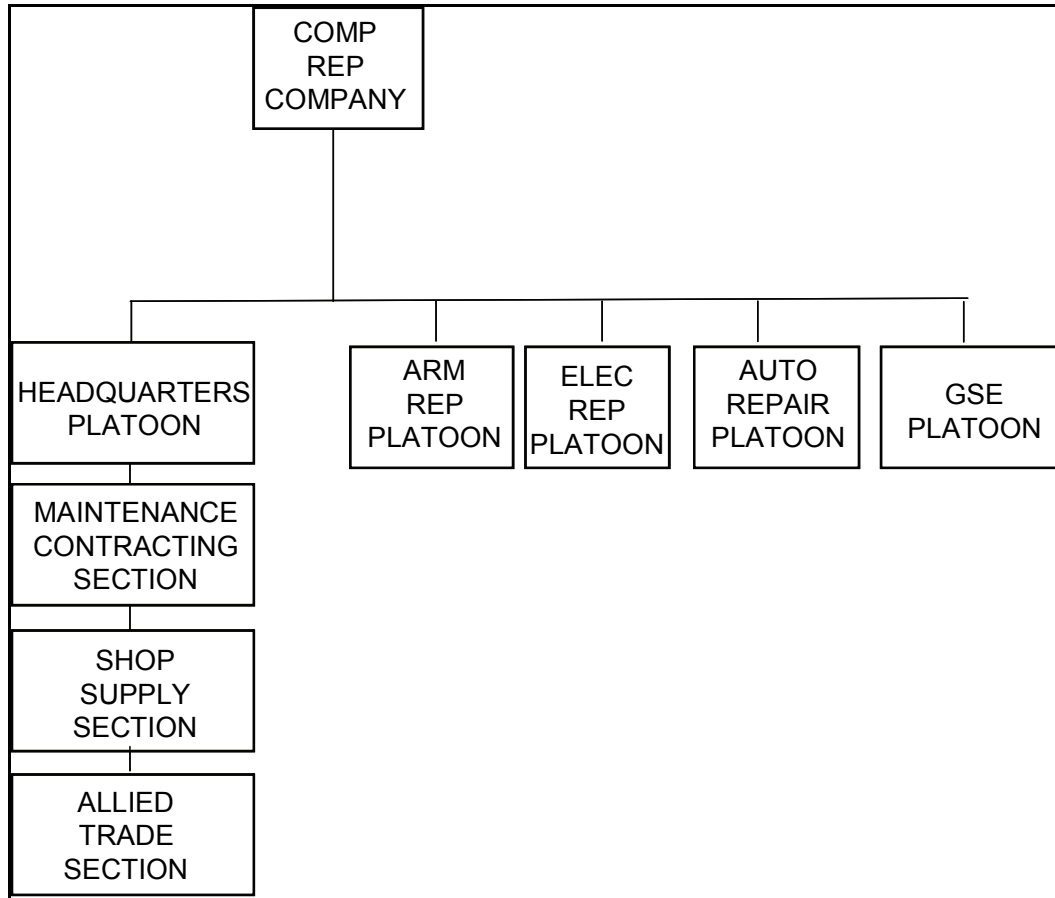

Figure 4-4. Component Repair Company

## SUPPLY

4-24. Providing the force with general supplies is the mission of the attached/assigned quartermaster elements of the CSSB and functional battalions. Supply operations must effectively support a brigade-based force. To accomplish this, Quartermaster units, tailored together with other sustainment units to form multi-functional CSSBs within Sustainment Brigades, provide logistics support at the operational level. The current force maneuver and support brigades have organic support capabilities that provide operational endurance. Command and control and management of supply operations begin at the TSC and its supporting multi-functional Sustainment Brigades, and is executed by CSSBs. Supply elements generally provide subsistence, general supplies, bulk fuel, heavy materiel, repair parts, and water. Personal demand items (Class VI) and medical supplies (Class VIII) are not typically provided by units under the C2 of the sustainment brigade, but must be considered during the planning process.

**CLASS I, FOOD AND FIELD FEEDING**

4-25. The current field feeding standard is expected to remain in effect. This feeding standard dictates that a ration is three quality meals each day, with the capability to distribute, prepare, and serve at least one Unitized Group Ration–A (UGR-A) or UGR-Heat & Serve (UGR-H&S) meal per day (METT-TC dependent). The family of operational rations used to support this standard consists of individual meals (Meal-Ready-to-Eat; Meal, Religious, Kosher/Halal; Meal, Cold Weather/Food packet, Long Range Patrol; along with the emerging First Strike Ration and Compressed Meal) and unitized group meals (UGR-A and UGR-H&S, along with the emerging Unitized Group Ration–Express (UGR-E)), plus enhancements such as bread, cereal, fruit, and salad and the mandatory supplement of milk to ensure the nutritional adequacy of the group rations. The inclusion of a cook-prepared hot meal in the standard of three quality meals per day is based on units having the required personnel and equipment necessary for implementation. During extended deployments of 90 days and beyond, the feeding standard is expanded to include the UGR-A Short Order Supplemental Menus. This option provides easy to prepare breakfast and lunch/dinner short order menus and affords choices in menu selection for Soldiers. The feeding standard applied when troops are deployed beyond 180 days includes the incorporation of the DA 21-Day menu that can be prepared using organic field kitchens or contractor logistics support. See FM 10-1, Quartermaster Principles, for more details.

**Class I Distribution**

4-26. Class I items are pushed from the strategic level (vendors and/or depots) to the operational area based on supported unit strength reports. When logistic personnel, rations, transportation, and equipment are in place, a “Pull” or “Request” system will be implemented as UGR-H&S and UGR-A are introduced. The mix of perishable and semi-perishable rations depends on the Operational Commander’s Feeding Policy and the availability of refrigerated storage and Subsistence Platoons. Class I stocks brought into the theater of operations will be moved to the Subsistence Platoon residing within Quartermaster Support Companies (QSC). The Commander’s Stockage Policy will determine the number of days of Class I supplies to be maintained at various levels/locations. As an example, stockage levels set at 10 days of supply (DOS) at theater level are reduced to 3 to 5 DOS in the Subsistence Platoon of the sustainment brigade.

4-27. Class I bulk will be transported from the strategic level to the operational level in 20- or 40-foot refrigerated and non-refrigerated containers. The TSC will maintain the predominance of theater Class I stockage, which will be maintained by the Subsistence Platoon(s) of the QSC located in the operational level Sustainment Brigade or an equivalent civilian organization. At this location, the QSC’s Subsistence Platoon(s) will also provide Class I area support to units located in the numbered Army level area. Rations are distributed in bulk from the operational level via internal single temperature refrigerated containers or leased refrigerated containers on semi-trailers, and via leased 20- or 40-foot ISO containers on semi-trailers for semi-perishable assets, to the Subsistence Platoon of the Sustainment Brigade CSSB supporting the higher tactical. The Class I distribution flow is depicted in Figure 4-5. It is envisioned that bulk Class I will be transported from the sustainment base to the Subsistence Platoon of the Sustainment Brigade CSSB Quartermaster Support Company, which will build support packages for the maneuver brigades. The rationale for the Subsistence Platoon shipping in bulk is: it more efficiently uses the limited transportation assets available; it most effectively supports large base-camp operations (as seen in Iraq); and it allows the QSC Subsistence Platoon to respond within the required 72 hour turnaround from the order placement to the order delivery for its customers. A 72 hour turnaround is required to respond to changes in operational pace and still support the Army’s field feeding policy to provide the Soldiers with at least one hot meal a day, METT-TC.



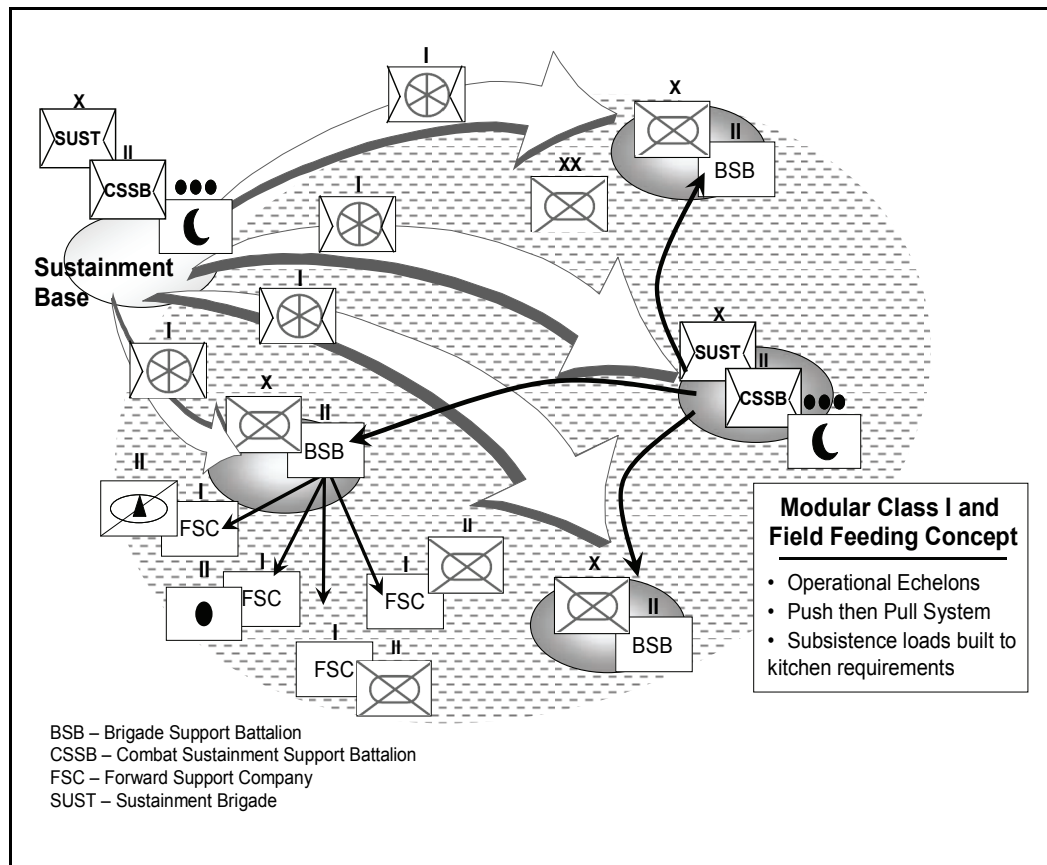

**Figure 4-5. Class I and Field Feeding Operations**

## WATER PRODUCTION AND DISTRIBUTION

4-28. Water production and distribution operations in the current force can be characterized by a greater degree of self-reliance by maneuver units. This is due to a mobile storage capability, organic water purification, and improved distribution system within the brigade. This added water generation capability, along with the reduction in echelons and mobility improvements, will enhance the integration of sustainment into the operational battle rhythm. Modular Quartermaster Water Purification and Distribution Companies provide tailored water production package capabilities, storage, and bulk area distribution at the operational and tactical levels. Arrival of water units into the theater of operations is synchronized in such a way that the Water Distribution System will expand from commercial packaged water distribution early on, to water production and distribution as the theater of operations matures. Water distribution and the dispersion of the Water Purification and Distribution Companies to support current forces are shown in Figure 4-6.

### Water Purification

4-29. Quartermaster Water Purification and Distribution Companies and Augmentation Water Support Companies are assigned to CSSBs in Sustainment Brigades. The Water Purification and Distribution Company can provide up to 360,000 gallons of potable water per day from a fresh water source at up to eight water points. When using a salt water or brackish water source, production equals 240,000 gallons. This company can store 160,000 gallons; 80,000 per platoon. The Augmentation Water Support Company for arid environments can purify up to 720,000 gallons from a fresh water source or 480,000 from a brackish water source, and store 1.9 million gallons.

### Water Support within Brigades

4-30. In temperate climates, water purification, packaging, storage, and distribution will take place in the BSB and JSOTF. The BSB has distribution assets to deliver limited package and bulk water forward to FSCs during replenishment operations. FSCs within BCTs do not have water support capability. Water will be issued using supply point distribution from the FSCs. Bulk water purification is able to be conducted forward of the BSB through the employment of high mobility multipurpose wheeled vehicle (HMMWV)-mounted light water purification systems. Water purification within the JSOTF may take place forward of the BSB.

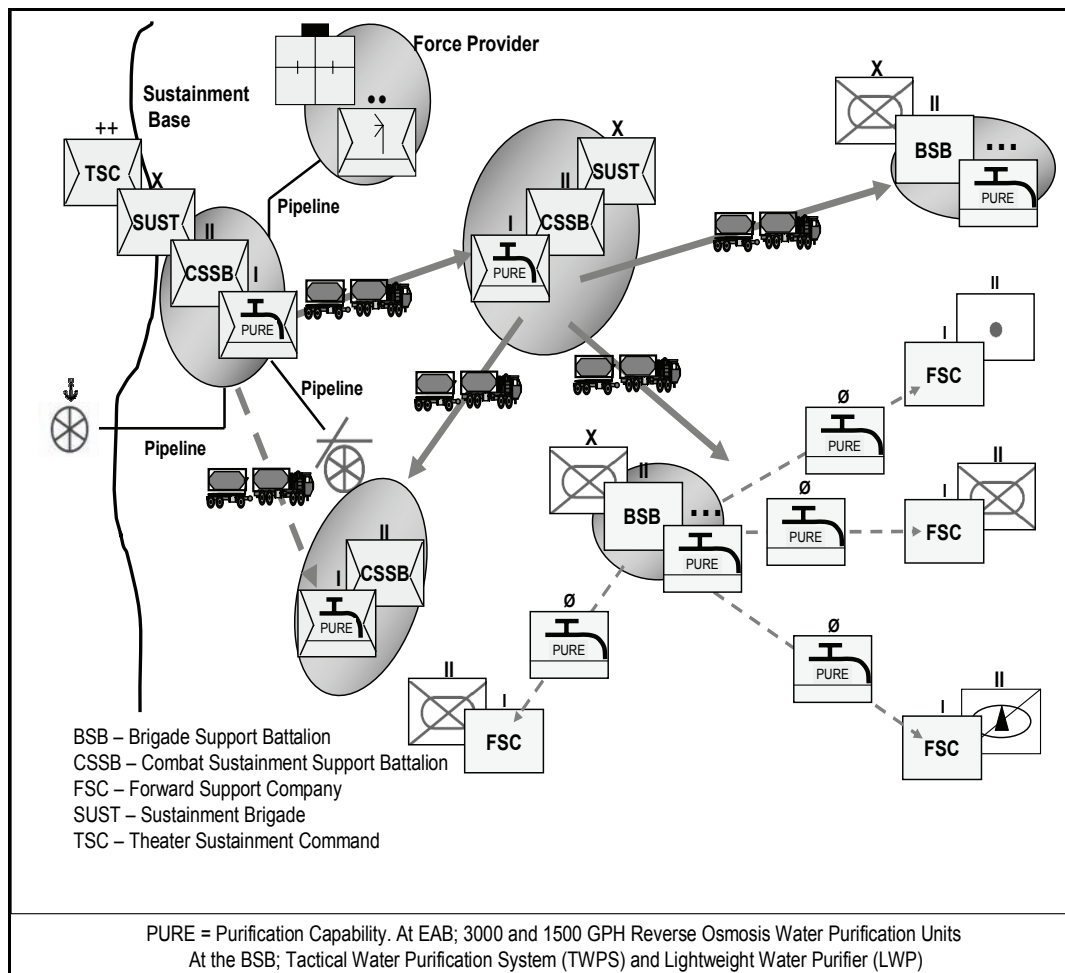

**Figure 4-6. Example of Water Distribution in a Mature Theater of Operations**

### Operations in Arid Environments

4-31. In an arid environment water sources are limited and widely dispersed, while requirements for potable water are increased. Therefore, operations in arid or other-than-temperate environments, place greater demand on purification, storage, and distribution capabilities than in other climatic conditions. A greater commitment of water assets at the operational level may be required due to limited raw water sources available and mobility requirements at tactical levels. Augmentation Water Support Companies may be employed to provide the additional capability required to meet the increased demand for water purification and storage. Line haul distribution will be accomplished using semi-trailer mounted fabric tanks transported by Transportation Medium Truck Companies.

## GENERAL SUPPLIES (CLASS II, III (P), IV)

4-32. Figure 4-7 shows the flow of general supplies from the sustainment base forward to the BCTs. This process is described in detail below. Supply distribution for general classes of supply is characterized by throughput of loads as far forward as the BSB and JSOTF (40-foot containers will not go forward of the sustainment brigade). Supply distribution is conducted by the QSC, assigned to the Sustainment Brigade CSSBs at the operational and higher tactical levels.

4-33. The QSC, as the Consolidated Supply Support Activity (CSSA), provides for the receipt, storage, and issue of 207.8 ST of Classes II, III (P), IV, VII, and IX (less aviation, missile repair parts, and communications security equipment) stocks per day. It packages/repackages supplies as required, to include retrograde and redistribution. The QSC is the center-post of the Distribution Hub at the sustainment base level, receiving all stocks as they enter the theater of operations that cannot be readily throughput to a unit destination. The QSC Area Support Platoons at the operational level configure pure pallet packages to satisfy unit requests or assemble support packages to re-supply the QSC at higher tactical levels.

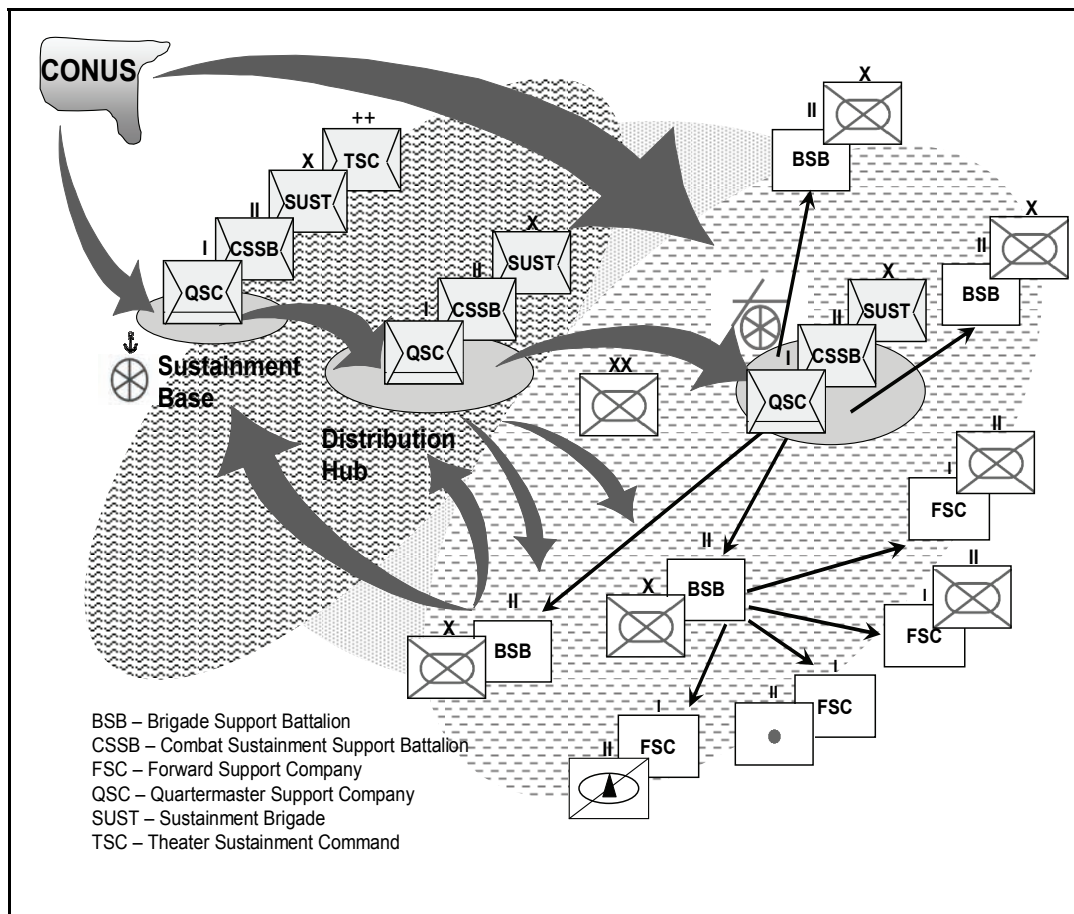

**Figure 4-7. Supply Distribution for General Supplies**

4-34. The QSC Area Support Platoons will build customized loads, combining pre-packaged loads received from designated distributors. These loads will be further combined with any required bulk supplies. Combined packages received from the strategic level will also be packaged for issue and forward movement to meet unit requests. These loads can be throughput as far forward as feasible.

4-35. Once supplies have been identified and configured for forward movement to the customer, the QSC will coordinate through its CSSB SPO for the most expeditious mode of transport. The TSC Support

Operations/Distribution Management Center will establish the priority of effort for and coordination of the supply flow, maintenance and component repair activities, transportation, and distribution assets.

**Quartermaster Support Company (QSC)**

4-36. The QSC (see Figure 4-8) provides C2 for two to four subsistence or area support platoons. It provides C2, food service, and supervision and common tools for unit level maintenance. The QSC is attached to a CSSB. When task organized with one subsistence platoon and three area support platoons, the unit can:

- Receive, store, and issue a cumulative of approximately 93.6 short tons (STONs) of Class I per day.
- Provide refrigeration for perishable rations and augment subsistence personnel for Class I issue points.
- Deliver perishable subsistence to Class I supply points.
- Receipt, store, issue, and account for 207.8 STONs of Class II, III(P), IV, and IX supplies, as follows:
  - Class II            40.41 STON
  - Class IV            119.04 STON
  - Class III (P)      6.12 STON
  - Class VII          30.36 STON
  - Class IX            11.88 STON
- Can operate up to six different locations.
- Provide limited configured loads.

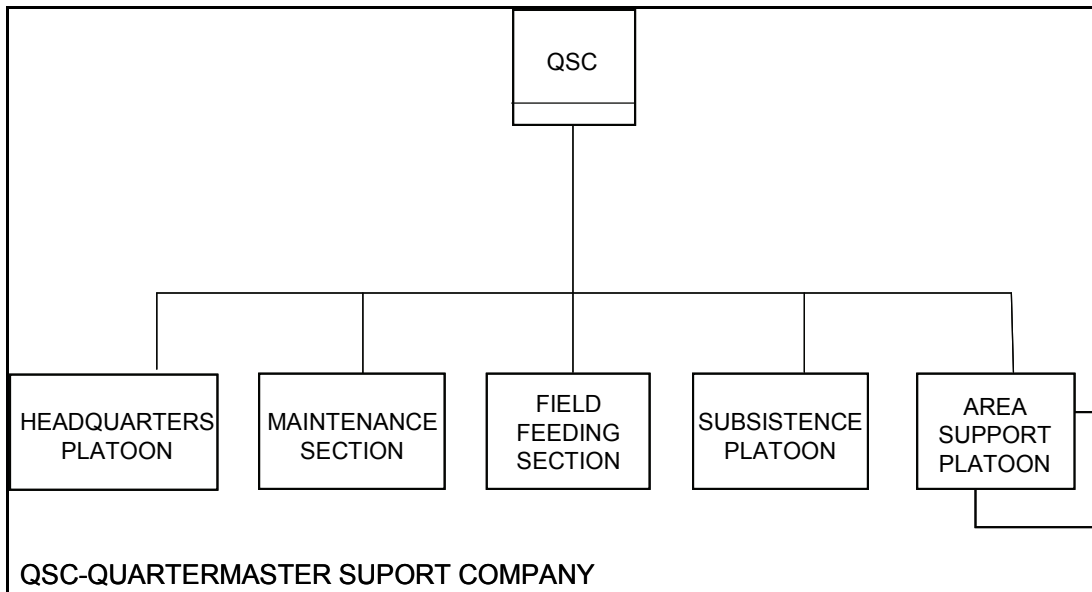

**Figure 4-8. Quartermaster Support Company**

**CLASS III (B)**

4-37. Quartermaster petroleum units will provide fuel support for all US (and potentially coalition) land-based forces. Sustainment brigades, specifically Quartermaster petroleum units and POL truck companies, will be involved in the reception and storage of POL from the refinery or terminal and the delivery to the BSBs distribution company (see Figure 4-9). At theater level, POL Support Companies will be assigned to a POL Supply Battalion in a POL Group. At division/corps level, POL Support Companies will be assigned to a CSSB in a Sustainment Brigade. Theater opening or theater distribution sustainment brigades

may be task organized with a Quartermaster pipeline and terminal operating company. Bulk petroleum will be distributed to the operational level for forward distribution to supported units. Figure 4-11 depicts the distribution of fuel from the operational to tactical level. Current force fuel operations are more tailorable and capable. Fuel is throughput directly to Division locations and fuel support assets have been added to the maneuver BCTs and Support Brigades. Operational level fuel distribution operations use pipeline/hose line and large capacity long haul POL transportation. By moving POL capability to the Sustainment Brigades in the Corps/Division area, they can be more responsive to the BCT off-cycle demands and surge requirements. The TSC, sustainment brigades, and divisions can all maintain visibility of bulk fuel quantities on hand in the units and at the supply points via BCS3.

### **Theater Level Petroleum Operations**

4-38. In a developed theater of operations, the Fuel Distribution System includes: the Off-shore Petroleum Discharge System, inland tank farms Tactical Petroleum Terminals (TPTs), and pipeline systems. With a theater structure in place, Operational Petroleum Pipeline and Terminal Operating (PPTO) Companies in a TSC POL Group establish the theater petroleum support base for products received from ocean tankers at marine petroleum terminals. The petroleum support base serves as a hub for receiving, temporarily storing, and moving fuels to Petroleum Support Companies (PSC) at the operational and higher tactical levels. Petroleum Supply Battalions at the operational level provide theater stocks and deliver fuel to the Sustainment Brigade PSCs at the higher tactical level. PSCs support the area distribution mission and POL truck companies deliver fuel to the BSBs in the BCTs.

4-39. Pipelines/hose lines (the most efficient mode) will be used to deliver fuel products as much as possible during initial operations (usually to the Sustainment Brigade supporting the division). Large-scale combat operations may justify the construction of coupled pipelines/hose lines using the Inland Petroleum Distribution System or a future more rapidly emplaced pipeline system to move bulk petroleum from theater storage locations forward. Air bases and tactical airfields are serviced by pipeline when feasible. When available, pipeline distribution is supplemented by tank type vehicles, railcars, and barges.

### **POL SUPPLY BATTALION**

4-40. The POL supply battalion's mission is to provide C2, administrative, technical, and operational supervision over assigned or attached petroleum supply companies and petroleum truck companies. Its capabilities include C2 of two to five petroleum supply and truck companies; planning for the storage, distribution, and quality surveillance of bulk petroleum products; maintenance of theater petroleum reserves; and operation of a mobile petroleum products laboratory. POL supply battalions are typically assigned to either the TSC or to a petroleum group. However, these battalions may be attached to the sustainment brigade performing the theater opening mission.

4-41. POL supply battalions at the operational level provide theater stocks and deliver fuel forward to the petroleum support companies (PSC) attached to sustainment brigades at the higher tactical level. PSCs in turn support the area distribution mission, while POL truck companies deliver fuel to the BSBs in the BCTs. The POL supply battalion headquarters is depicted in Figure 4-10.

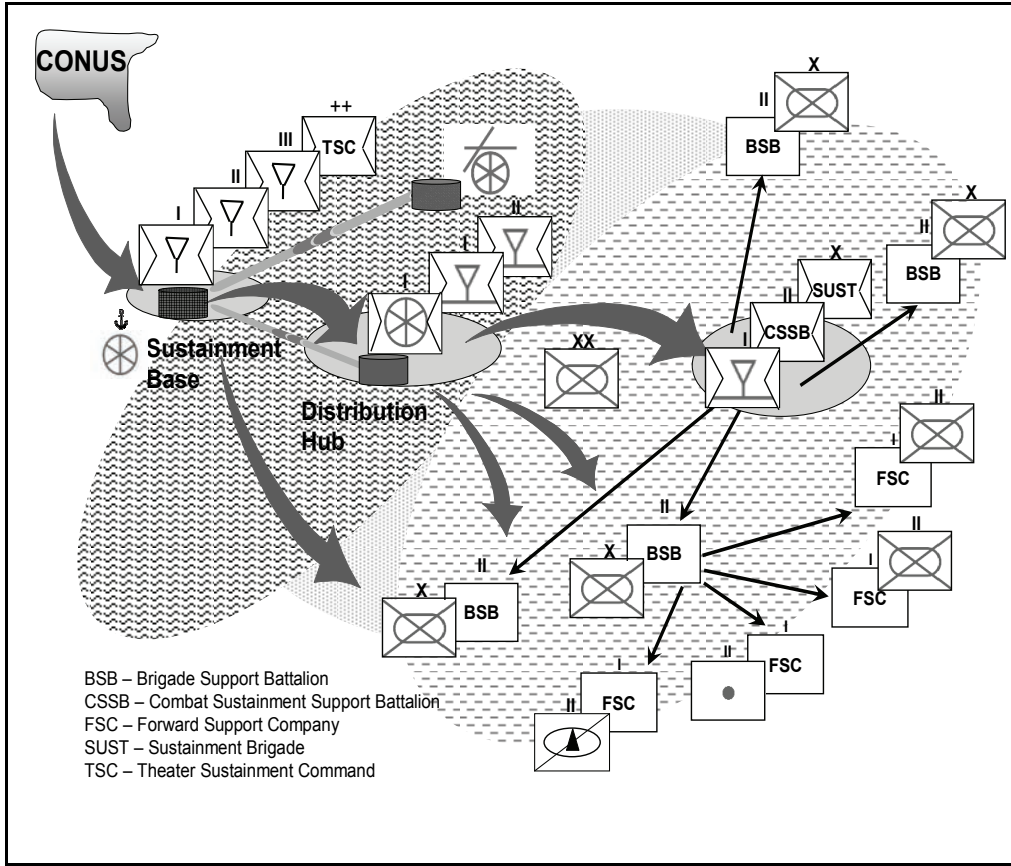

Figure 4-9. Fuel Operations

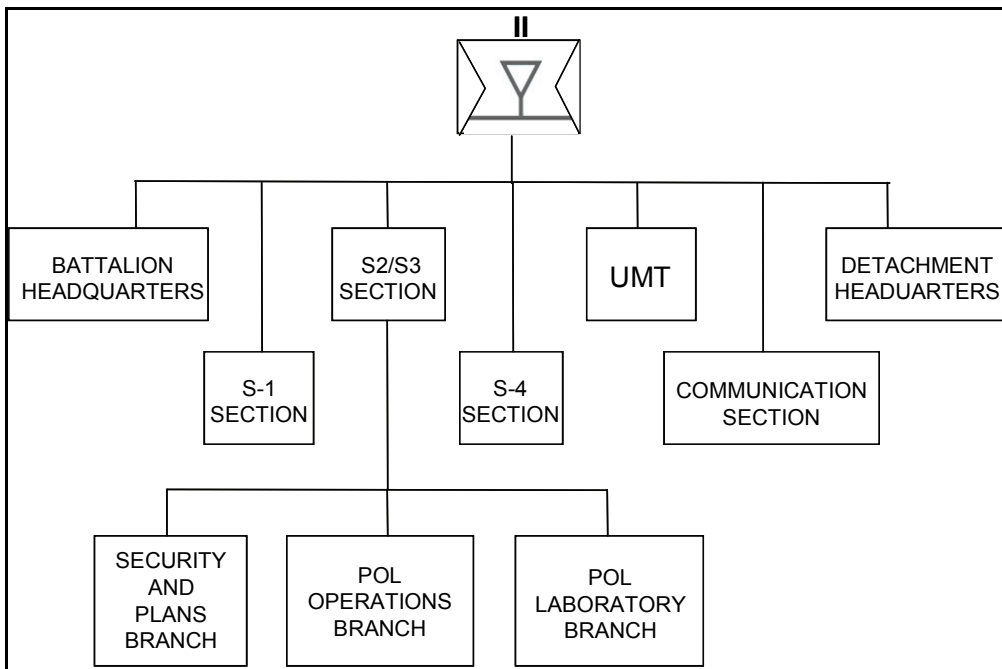
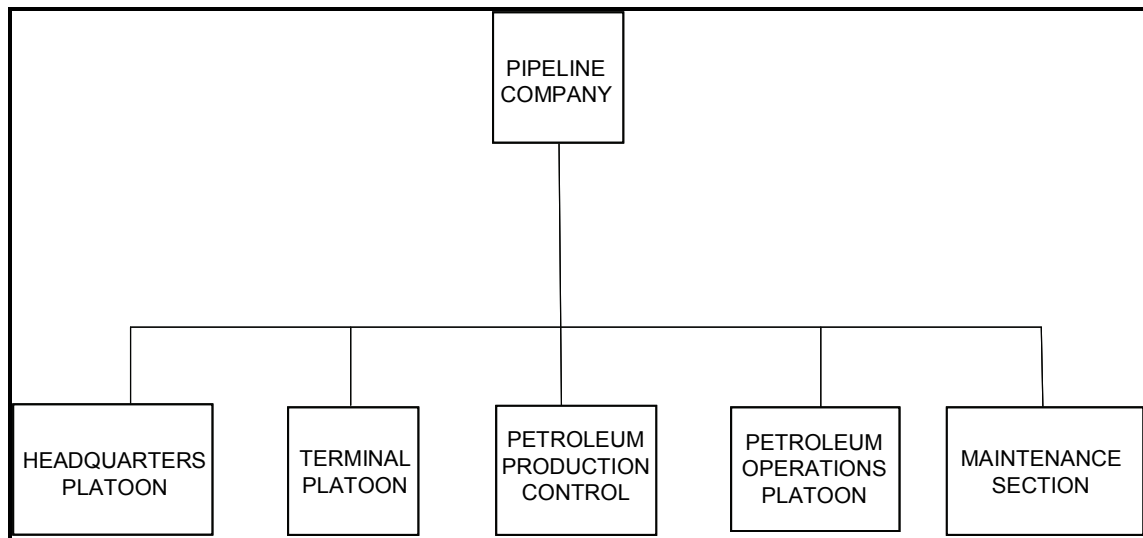

Figure 4-10. POL Supply Battalion Headquarters

### Quartermaster Petroleum and Terminal Operations Company

4-42. The Quartermaster petroleum and terminal operations company (PPTO) (see Figure 4-11) has as its mission to operate petroleum pipeline and terminal facilities for receipt, storage, issue, and distribution of bulk petroleum products. It is normally assigned to a petroleum pipeline and terminal operating battalion or a petroleum group. Its capabilities are to:

- Operate fixed terminal facilities for storage of up to 2,100,000 gallons of bulk petroleum. This normally consists of two tank farms, each with a capacity of up to 250,000 barrels or a tactical petroleum terminal (TPT) with a storage capability or up to 90,000 barrels.
- Operate up to 90 miles of pipeline for distribution of approximately 720,000 gallons per day.
- Operate six pump stations, 24 hours per day, to deliver bulk product through 6- or 8-inch multi-product coupled pipeline.
- Operate facilities for shipment of bulk product by coastal tanker, barge, rail, and tank trucks.
- Maintain a prescribed reserve of bulk product for the theater of operations.
- Operate a fuel system supply point for bulk issue operations.



**Figure 4-11. Quartermaster Petroleum and Terminal Operations Company**

### Quartermaster POL Support Company

4-43. There are two types of POL Support Companies: the POL Support Company (50K) and the POL Support Company (210K). The POL Support Companies (see Figure 4-12) receive, store, issue, and provide limited distribution of bulk petroleum products in support of division/corps or theater operations. Line haul distribution of bulk POL is performed by POL truck companies. The POL Support Company (210K) is normally located in the theater area and assigned to a POL supply battalion. The POL Support Company (50K) is normally located in the division area and assigned to a CSSB within a sustainment brigade. When task organized with three POL Support Platoons they have the following capabilities:

- Store up to 1,800,000 gallons when organized with three POL Support Platoons or 5,040,000 when organized with three POL Support Platoons (210K).
- Receive and issue up to 1,200,000 gallons per day when organized with three POL Support Platoons (50K) or 1,935,000 gallons per day when organized with three POL Support Platoons (210K).
- Establish and operate two hot refueling points using two Forward Area Refueling Equipment systems for transitory aircraft operating in their area.

4-44. The area support section of each POL platoon can store up to 120,000 gallons of bulk petroleum at one location and 60,000 gallons at each of two locations. The distribution section of each POL platoon can distribute 48,750 gallons of fuel daily based on 75 percent availability of fuel dispensing vehicles at two trips per day.

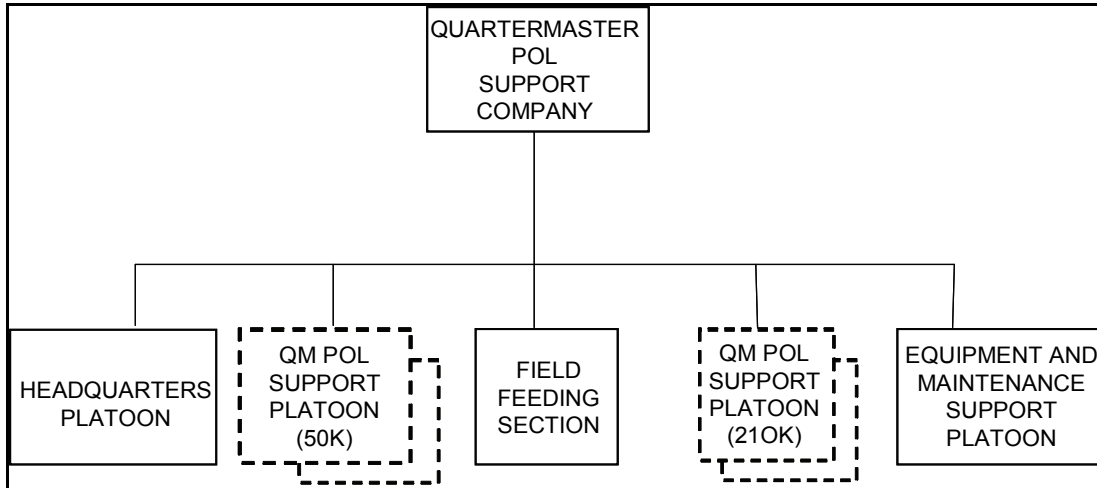

Figure 4-12. Quartermaster POL Support Company

### CLASS V, AMMUNITION SUPPORT

4-45. The sustainment brigade provides ammunition support (see Figure 4-13) with various organizations and from various locations based upon the maturity of the theater of operations and the mission of the supported units. Sustainment brigades operate Theater Storage Areas (TSA) at sustainment bases and ammunition storage points (ASP) at the distribution hub and other forward locations. Sustainment brigades operate Ammunition Support Activities (ASA) that provide the capability to receive, store, and issue Class V. Ammunition elements receive, store, and issue ammunition items.

4-46. The ammunition logistics system provides to the force the right type and quantity of ammunition in any contingency. The challenge is to move required amounts of ammunition into a theater of operations from CONUS and other prepositioned sources in a timely manner to support an operation. The system must be flexible enough to meet changing ammunition requirements in simultaneous operations around the world. The objective of the system is to provide configured Class V support forward to the force as economically and responsively as possible with minimized handling or reconfiguring and quickly adapt to changes in user requirements. The unique characteristics of ammunition complicate the system. These factors include its size, weight, and hazardous nature. It requires special shipping and handling, storage, accountability, surveillance, and security. Munitions are managed using different methods depending on the level of command.



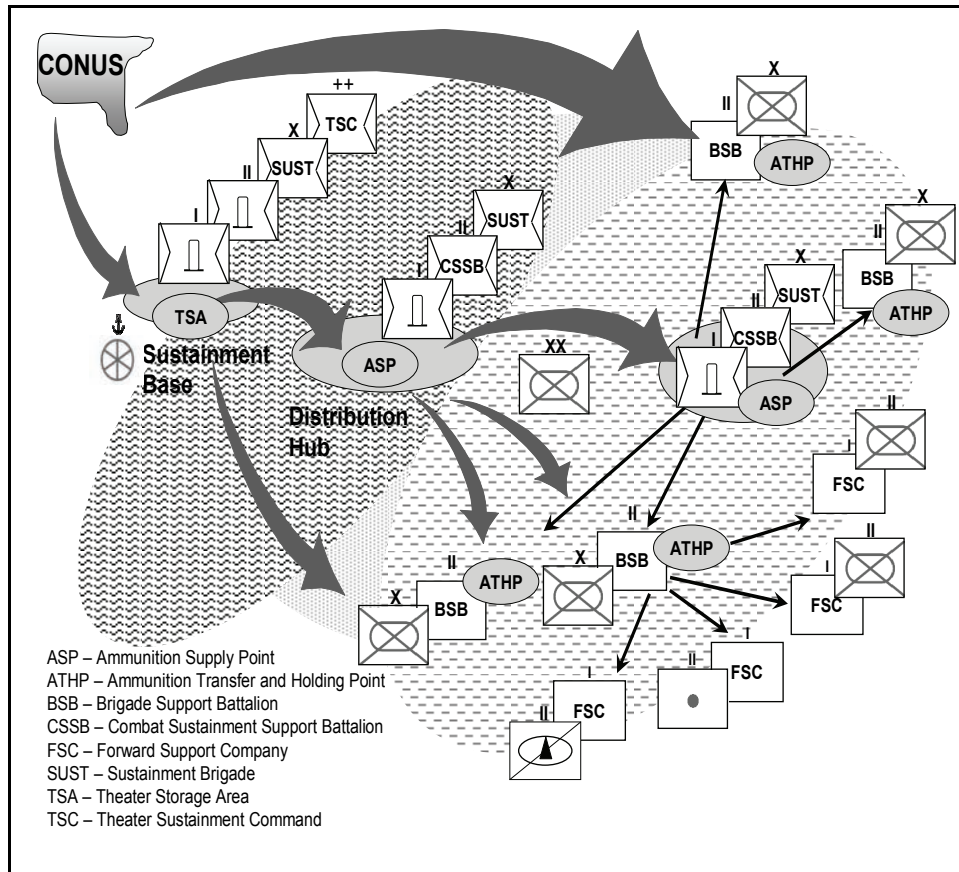

Figure 4-13. Ammunition Support

### Theater Storage Area (TSA)

4-47. The TSA encompasses the storage facilities located at the operational level. This is where the bulk of the theater reserve ammunition stocks are located. Ammunition companies, with a mixture of heavy- and medium-lift platoons, operate and maintain TSAs. The primary mission of the TSA is to receive munitions from the national level, conduct the bulk of operational level reconfiguration, and distribute munitions to forward ASA locations and BCT ATHPs. The TSA will build those configured loads that cannot be shipped into a theater of operations due to explosive compatibility conflicts for international shipment. Ammunition will be managed by either an ammunition battalion or CSSB based upon METT-TC

4-48. The sustainment brigade must keep the TSC DMC informed of storage or handling limitations or shortages in each TSA. When mission analysis indicates more than one TSA or port facility is required, the GCC should plan for early deployment of an ordnance ammunition battalion to provide mission C2 of munitions distribution at the TSC level.

### Ammunition Supply Points (ASP)

4-49. Ammunition supply points (ASPs) provide the capability to receive, store, issue, and perform limited inspections and field level munitions maintenance support. The sustainment brigade gains such capability when it is assigned one or more ammunition ordnance platoons. The CSSBs attached to the sustainment brigade will contain ammunition ordnance companies and ASP. The number of companies and ASPs varies based upon the role of the sustainment brigade to which they are attached and the size and mission of the supported organizations.

4-50. ASPs receive, store, issue, and maintain ammunition based on the capabilities of assigned ammunition platoons. ASP stockage levels are based on tactical plans, availability of ammunition, and the

threat to the resupply operation. Additionally ASPs are the primary source of resupply of ATHP located in BCTs.

**Ammunition Flow**

4-51. Ammunition issued to users is replaced by ammunition moved up from theater storage areas. In turn, ammunition stockage levels at the theater storage areas are maintained by shipments from CONUS or out of other theater locations. The quantity of ammunition shipped forward is determined by the amount on hand, current and projected expenditures, and the controlled supply rate (CSR).

4-52. Each battalion S-4 transmits a request for resupply of ammunition for units through the brigade S-4 to the BAO. The BAO coordinates and controls the use of Class V supplies for the brigade, consolidates the brigade requests, and submits them to the sustainment brigade, ESC/TSC. The TSC, in coordination with the numbered Army G-4, reviews all requests and balances them against the CSR issued by the theater storage activity. The numbered Army issues the CSR to support the units. Some ammunition requirements are prioritized due to scarcity and some may not be issued due to unavailability. The BAO through TSC coordinate for the shipment of ammunition to the ATHP.

4-53. Captured enemy ammunition (CEA) must be kept separate from US munitions; however, it must be accounted for, stored, and guarded using the same criteria that applies to US munitions. When an enemy ammunition cache is found or captured, the commander must assess the combat situation. He/She must decide whether to destroy the CEA because of the situation or to secure it and request explosive ordnance disposal support. During retrograde operations, leaders must ensure safety policies and procedures are carefully observed as these operations can be particularly hazardous and serious injury has occurred in the handling of CEA. Close control of CEA is required. Positively identified and serviceable CEA may be compatible for use in US or allied forces weapon systems. These munitions can potentially ease the burden on the ammunition supply system. CEA can also be used as a substitute for bulk explosives during demolition operations. See FM 4-30.1 and FM 4-30.13 for more information.

**Ammunition Battalion**

4-54. The ammunition battalion’s mission is to C2 ammunition companies and other attached units. It also provides supervision of ammunition support operations. The ammunition battalion is usually assigned to an operational-level sustainment brigade. For further information see FM 4-30.1. Its core capabilities are:

- C2 and staff planning for two to five subordinate units (see Figure 4-14 for Ammunition Battalion HQs organizational structure).
- Technical direction over ammunition support missions of subordinate units, except inventory management functions for which the TSC distribution management center (DMC) is responsible.
- Maintaining a consolidated property book for assigned units.

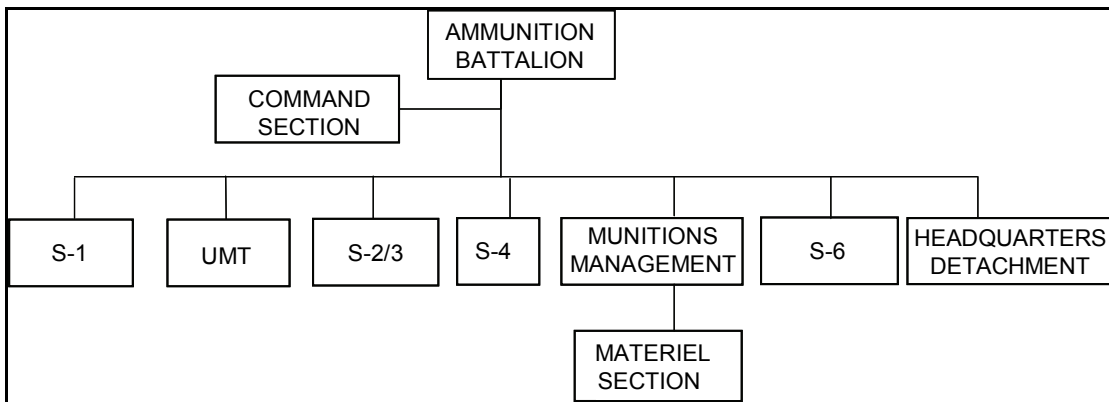

**Figure 4-14. Ammunition Battalion Headquarters**

### Ammunition Ordnance Company

4-55. The mission of the ammunition ordnance company (see Figure 4-15) is to provide command, control, and administrative, planning, and logistical support for ammunition platoons. It is normally assigned to an ammunition battalion or a CSSB.

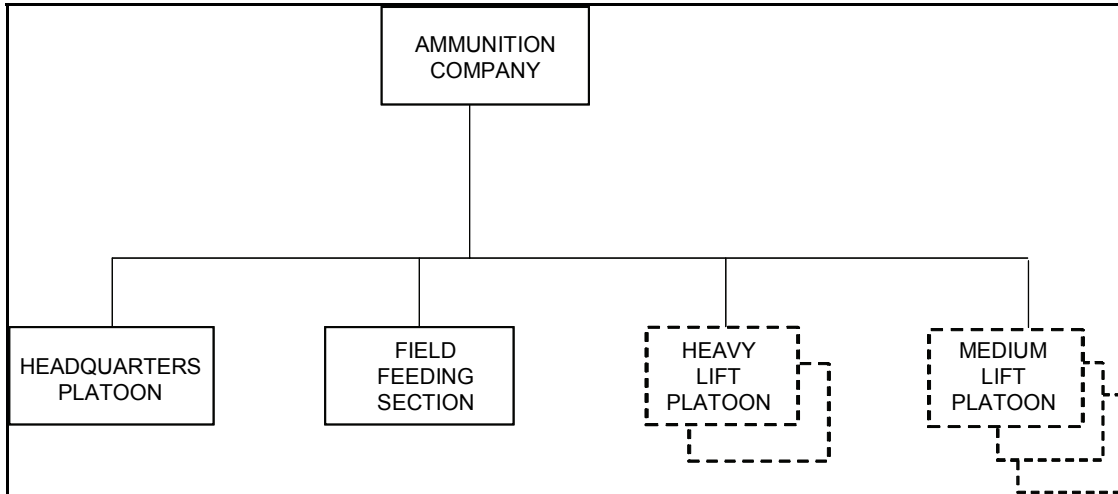

**Figure 4-15. Ammunition Ordnance Company**

### CLASS VI

4-56. Soldiers usually deploy with a 60-day supply of health and comfort items. Health and comfort packs (Class VI) can be supplied through supply channels. Tactical field exchanges provide Class VI supply support beyond the health and comfort packs. Class VI support can be limited to basic health and hygiene needs or expanded to include food, beverages, and other items based upon the requirements outlined by the theater commander. The availability of health and comfort packs and Class VI items can greatly enhance morale.

### CLASS VII (MAJOR END ITEMS)

4-57. Due to their cost and critical importance to combat readiness, major end items (Class VII), are intensely managed and controlled through command channels. They will be distributed to the brigade support battalion (BSB) distribution company from the quartermaster support company (QSC) in the sustainment brigade or from the strategic level as depicted in Figure 4-16.

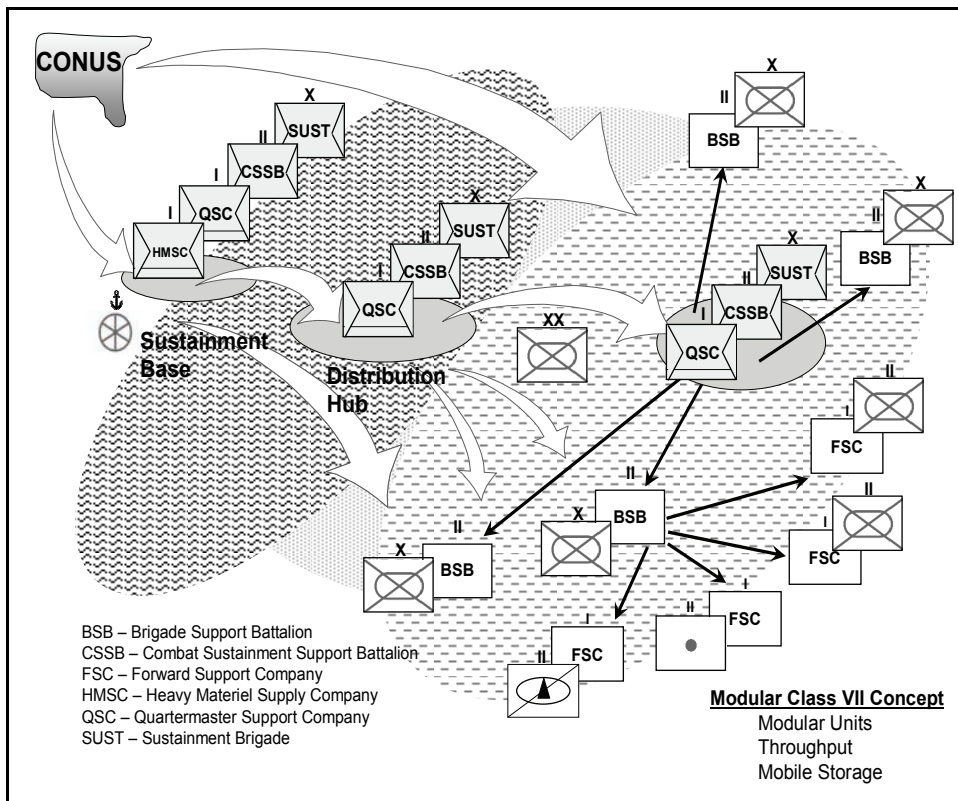

**Figure 4-16. Class VII Operations**

**CLASS VIII**

4-58. Theater-level inventory management of Class VIII (see Figure 4-17) will be accomplished by a team from the medical logistics management center (MLMC). The medical community performs all supply functions for Class VIII, but relies on the sustainment brigade and subordinates to transport the supplies unless they are transported by ambulance. The MLMC support team collocates with the DMC of the TSC/ESC providing the medical command with visibility and control of all Class VIII inventory. When an ESC is deployed, an element from the MLMC will also collocate in their DMC. The medical logistics company (MLC) in the MMB will serve as the consolidated forward distribution point for Class VIII.

4-59. Once supplies are identified and configured for forward movement to the customer, the MLC will submit transportation movement requests to the sustainment brigade and the MCB for appropriate transportation assets for forward movement. See FM 4-02.1 for definitive information on the medical logistics system.

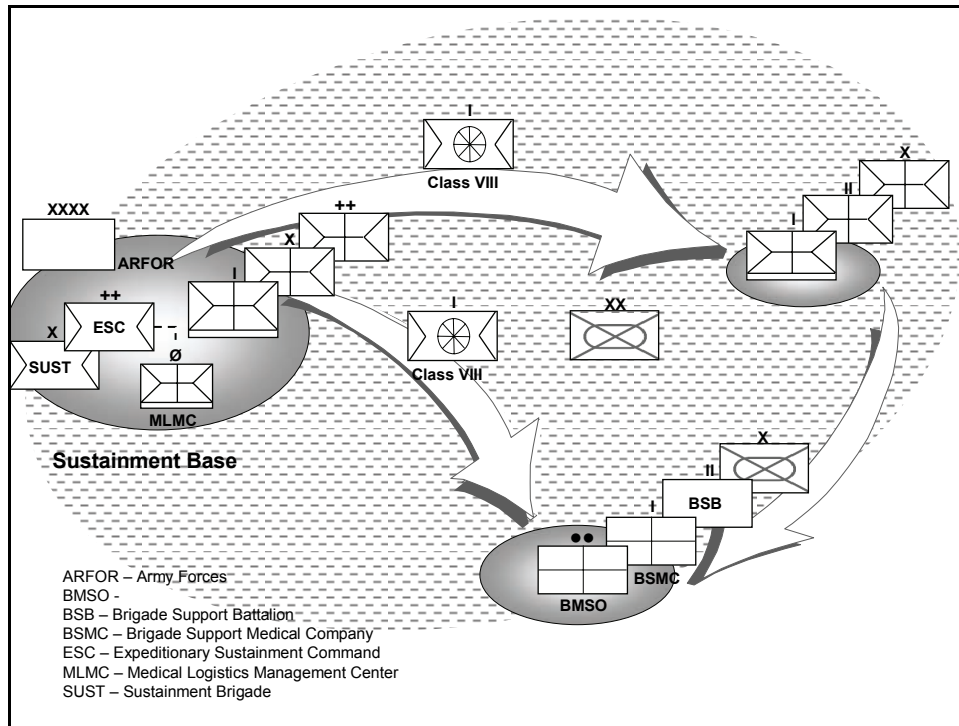

Figure 4-17. Class VIII Distribution

### CLASS IX (REPAIR PARTS)

4-60. Figure 4-18 depicts the Class IX flow from the strategic sustainment base to the end user. Class IX may be throughput from the theater sustainment base to the BSB depending on if the item(s) are critical in the fight. Other Class IX may be throughput to the sustainment brigade.

4-61. CSSBs receive, store, and issue Class IX items and configure/reconfigure loads, as required, in support of sustainment operations, to include retrograde and redistribution. The area support platoons assigned to the QSC, can receive, store, and issue Class IX items at either one or two locations, supporting 8,000 Soldiers at one location or 4,000 Soldiers at each of two locations. The area support platoons provides field and sustainment support as part of the QSC mission. These functions may be accomplished separately. The number of QSCs required in the division is METT-TC tailored.

4-62. The QSC in the CSSB of the sustainment brigade receives the Class IX repair parts and configures loads as required, to include retrograde and redistribution responsibilities. The QSC establishes the CSSA that will receive, store, and issue the theater stockage levels established by the GCC. The QSC also provides support to units within the theater base. Since the repair of Class IX repairable items will be conducted at the sustainment maintenance facilities at the theater base, repaired items will be re-introduced into the supply system at the QSC CSSA.

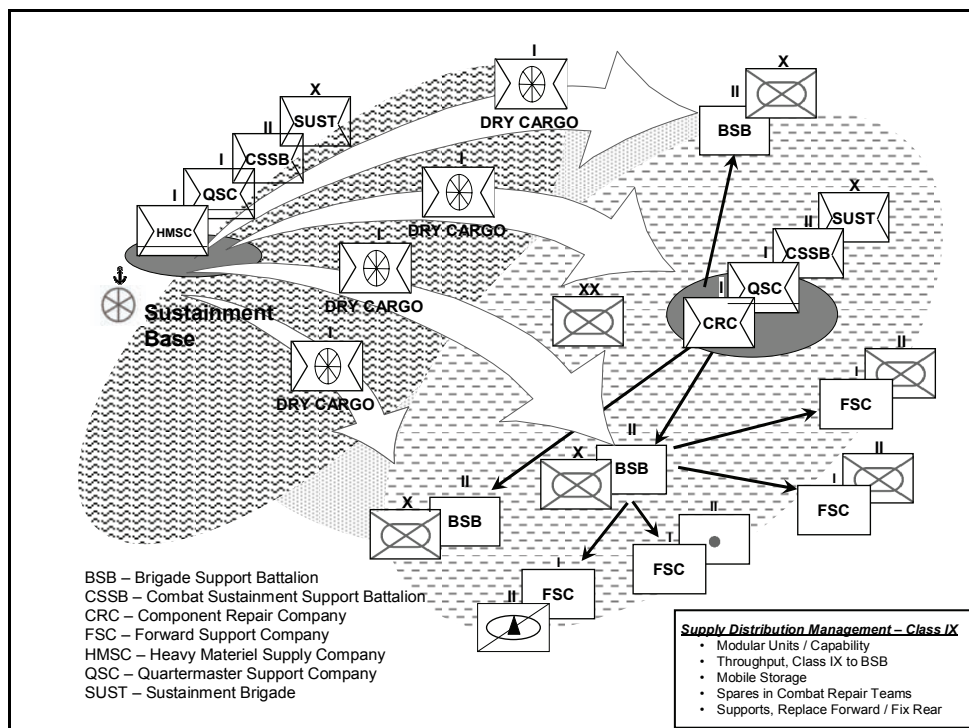

Figure 4-18. Class IX Operations

## FIELD SERVICES

### MORTUARY AFFAIRS (MA)

4-63. The MA program is designed to support war and stability operations including mass-fatality situations. For non-contingency situations each Service provides or arranges support for its deceased personnel. Roles and responsibilities for MA are outlined in the Department of Defense Directive 1300-22, which designates the Secretary of the Army as the executive agent for MA (see JP 4-06 and FM 4-20.64).

4-64. The Theater Sustainment Command (TSC) is the Army organization responsible for providing CUL within the theater of operations, to include MA support. The TSC commander, or a designated representative, determines the responsibility and placement of theater MA assets within the JOA. Normally, this is accomplished through coordination with the JMAO. The sustainment brigades exercise tactical/operational control over MA assets while the TSC exerts technical control over the theater-wide MA mission and executes any required adjustments in mission support in coordination with the sustainment brigades. If neither the TSC nor the ESC deploys to an AO and the sustainment brigade is the senior sustainment HQ in the AO, then the sustainment brigade will exert technical control over the MA mission and would perform all functions/actions listed in the following discussion as being performed by the TSC.

4-65. The TSC commander, together with the JMAO, must produce a plan that places MA assets where they can best support both current and future operations within the JOA. This places an inherent responsibility upon the JMAO and TSC to ensure that MA assets are properly positioned on the time-phased force deployment data list during the planning process. As part of the planning process, MA operations must be included in OPLANs, contingency plans, and SOPs. These plans and procedures should cover unit responsibilities as well as the employment, relocation criteria, and allocation of MA personnel and equipment throughout the JOA.

4-66. The Army MA Program is divided into three distinct programs: Current Death Program, Concurrent Return Program, and Graves Registration Program. Theater MA support during major operations is

provided through the Concurrent Return and Graves Registration Programs. This support includes the initial search and recovery, tentative identification, coordinated evacuation, and decontamination (if necessary) of remains and personal effects (PE). Each MA program addresses the federal responsibility for recovery and evacuation of US military personnel, government employees, and US citizens not subject to military law. Per the Geneva and Hague conventions, commands also have to address the recovery and evacuation of Multinational, Enemy Prisoners of War, Enemy, and host nation dead.

4-67. Mortuary affairs operations for Army forces rests within the GCC's theater organization. The Joint Mortuary Affairs Office (JMAO) has responsibility for the Joint Mortuary Affairs Points (JMAP) within a JOA. For more information on JMAO responsibilities refer to JP 4-06.

4-68. During multinational operations, MA staff planners must ensure that joint doctrine takes precedence. Specifically, it is imperative that MA planners and MA personnel process all remains in the same manner in accordance with JP 4-06 and all applicable international and cooperative agreements in the specific theater of operations.

### **MA Concept of Operations**

4-69. The MA program starts at the unit level with limited search and recovery operations and continues until remains are returned to the person authorized to direct disposition and all personal effects (PE) are returned to the person eligible to receive effects. Unit commanders are responsible for the initial search and recovery operations within their AO. Every unit is responsible for designating a search and recovery team to conduct search and recovery operations during the combat phase of operations. Instilled with the MA motto that all remains are to be treated with the utmost "dignity, reverence, and respect," these unit teams must be briefed on local customs and courtesies on dealing with remains. Upon recovering remains, a unit search and recovery team will evacuate those remains to the closest MA collection point (MACP). MA personnel set up MACPs, theater mortuary evacuation points (TMEPs), and PE depots throughout the theater of operations, as is depicted in Figure 4-19. Remains recovered by unit initial search and recovery operations are evacuated to the nearest MACP. From the receiving MACP, MA personnel evacuate the remains to the TMEP. The preferred method of evacuation is directly from the initial MACP to the TMEP; however, the tactical situation may dictate that remains be evacuated through several MACPs before reaching the TMEP.

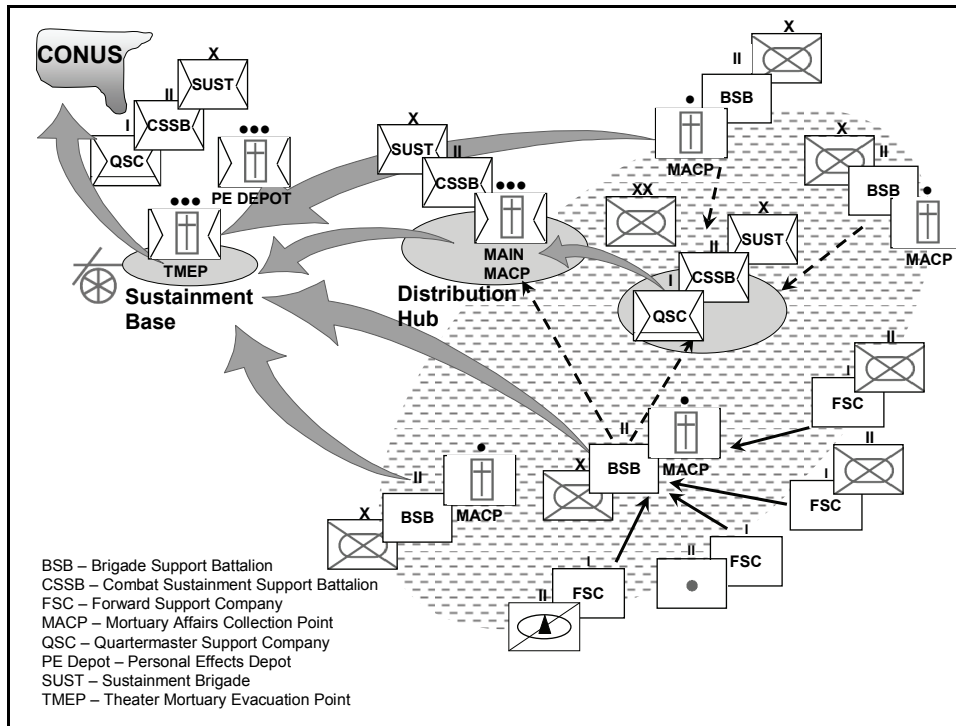

**Figure 4-19. Mortuary Operations**

4-70. MA assets are managed as theater assets. MA units are deployed as augmentation elements and do not have the personnel, equipment, or supplies required for self support. MA augmentation elements are sustained by the units which they support. A MA Company Support Operations Section is deployed as an Early Entry Module (EEM) to support operational planning. Upon arrival, it will report to the Theater Mortuary Affairs Officer (TMAO) or a Sustainment Brigade Mortuary Officer, to plan and coordinate RSOI of follow-on MA elements.

4-71. Advanced decision support systems will be used to enable the JMAO, TMAO, and MA to more efficiently develop Operation Plans (OPLANS), Operation Orders (OPORDs), and Fragmentary Orders (FRAGOs). Decision support tools will provide information to analyze requirements and enable timely decisions during changing requirements. They will enable publication of matrices and overlays to the Common Operational Picture depicting MA asset locations throughout the JOA. This will enable units to expedite remains evacuations. Commanders and authorized personnel at the BCT/direct reporting unit level and above will have access to the Mobile Integrated Remains Collection System MA reporting and tracking system to allow them to track evacuation status.

### MA Capabilities

4-72. The Quartermaster Collection Company's (MA) mission (see Figure 4-20) is to establish, operate, and maintain MACPs. Company personnel receive, tentatively identify, and conduct evacuation operations for deceased US military and certain US civilian and multinational personnel; and maintain essential records and reports. The company is designed to be tailorable; maintaining the ability to deploy at the section level. This is essential to support the full spectrum of Army operations tailored to the operational environment.

4-73. The five forward collection platoons of the MA Collection Companies are organized into a headquarters element and four collection sections, each of which establishes a MACP. Each MACP will generally be assigned to support a BCT-sized element. Upon establishment, the MACPs receive, process, and coordinate evacuation of remains. Each MACP is able to receive, process, and coordinate evacuation for 20 remains per day.



4-74. The MA main collection platoon is organized into three sections: headquarters, receiving, and evacuation. These sections together provide MA DS at the operational level and establish the main collection platoon that receives remains and PE from the forward MACPs. Additionally, the main collection point maintains the ability to receive remains and PE directly from surrounding units on an area support basis. The main collection platoon then coordinates evacuation of received remains and PE to the TMEP. The main collection platoon may be tasked to act as the Mortuary Affairs Decontamination Collection Point or the TMEP until a quartermaster (QM) MA Company arrives into the theater of operations.

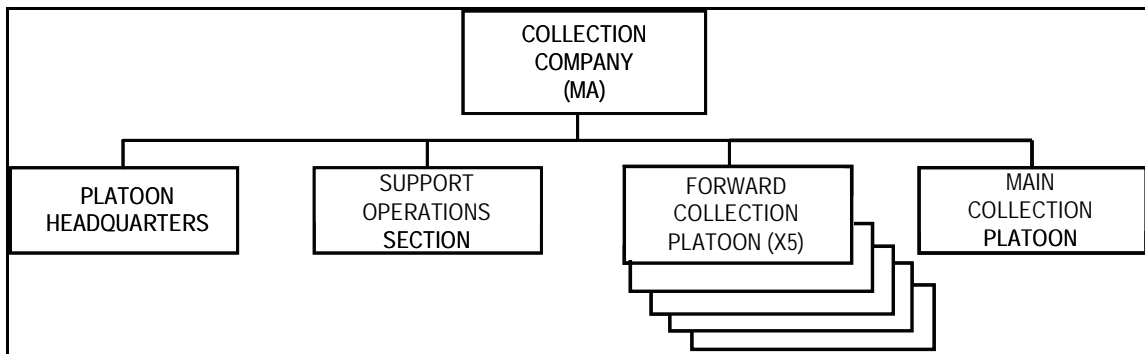

Figure 4-20. Mortuary Affairs Collection Company

4-75. The QM Collection Company (MA) may also be tasked to operate a TMEP, PE transfer point, and to inter/disinter remains until the QM MA Company arrives into the theater of operations. Since these are non-resourced missions, this will reduce the capabilities of the forward collection point operations.

4-76. The Quartermaster Mortuary Affairs Company (see Figure 4-21) mission is to establish, operate, and maintain up to two TMEPs to move deceased US military, coalition, and civilian personnel to CONUS/OCONUS military mortuaries or conduct theater interment operations; establish and operate up to five MACPs; and establish and operate a personal effects depot. The Support Operations Section is responsible for the proper allocation and placement of the company's MA assets in the operational area. Upon arrival, the section reports to the TSC MA officer for integration into the TSC Sustainment Operations Division. Once integrated, this cell coordinates and controls assigned MACPs; search and recovery operations; and evacuation operations for deceased US military, certain US civilian, and coalition personnel. The QM MA Company Support Operations Section must establish communication with the QM Collection Company (MA) Support Operations Section as soon as logistically possible. This is necessary to establish a common operational picture (COP) of all MA operations. Additionally, the Support Operations Section is the primary net control station for the QM MA Company.

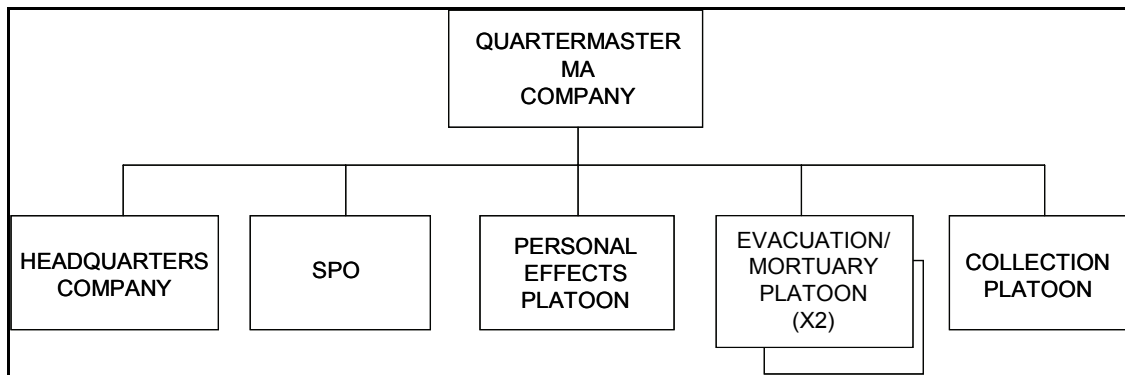
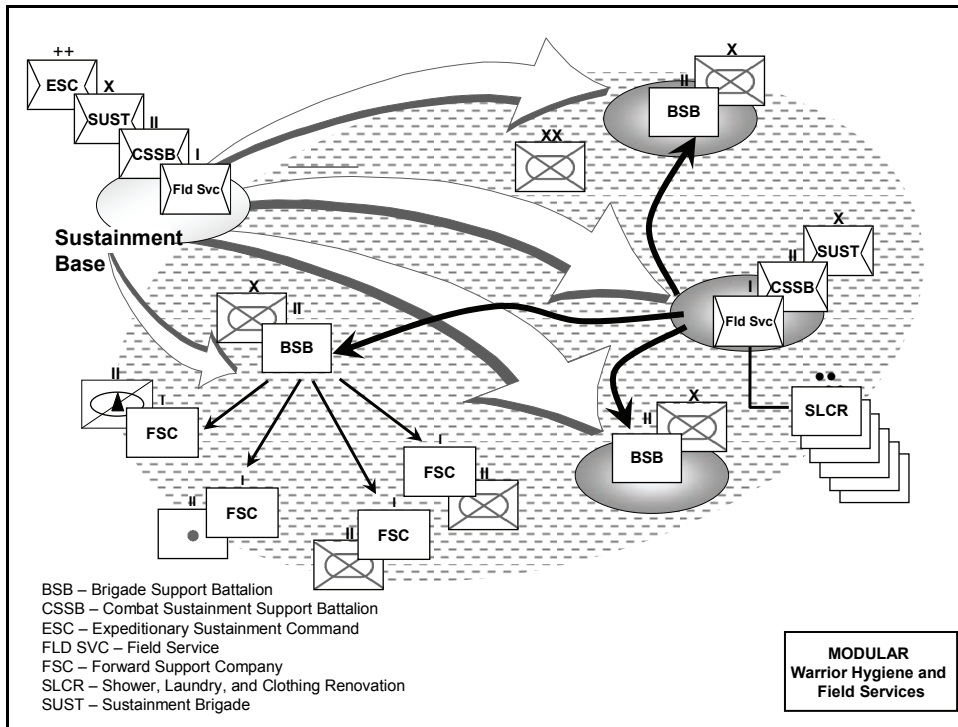

Figure 4-21. QM Mortuary Affairs Company

4-77. The QM MA Company PE Depot Platoon receives, stores, safeguards, and ships personal effects of remains processed within the theater of operations. The platoon is organized into a headquarters element and three additional sections: receiving, storage, and disposition. The Evacuation/Mortuary Platoon is responsible for the operation of a TMEP and/or a temporary interment site. The platoon is organized into a headquarters element and two additional sections: processing and evacuation/temporary interment. The Collection Platoon is organized into five sections, each of which establishes a MACP. The MACPs receive, process, and coordinate evacuation of remains and associated PE. Each MACP is able to receive, process, and coordinate evacuation for 20 remains.

**SHOWER AND LAUNDRY SERVICES**

4-78. The current force conducts field hygiene operations through the utilization of field sanitation teams located at the company level. The Sustainment Brigade, Combat Sustainment Support Battalion's Quartermaster Field Service Company supports the field sanitation teams through shower, laundry, and clothing repair (SLCR) sections dispatched from echelons above brigade (see Figure 4-22). Shower, laundry, and clothing renovation (SLCR) capabilities resident within the Quartermaster field services company (see Figure 4-23) are provided from the sustainment brigades with projection as far forward as possible. The mission is to provide Soldiers a minimum of a weekly shower and up to 15 pounds of laundered clothing each week (comprising two uniform sets, undergarments, socks, and two towels). The Quartermaster Field Service Company will provide SLCR for supported units. The Quartermaster Field Service Company can be moved forward to provide field services for the BCT. Each SLCR Platoon has 3 SLCR Teams which can each support 500 Soldiers per day/3,500 Soldiers per week.



**Figure 4-22. Hygiene and Field Services**

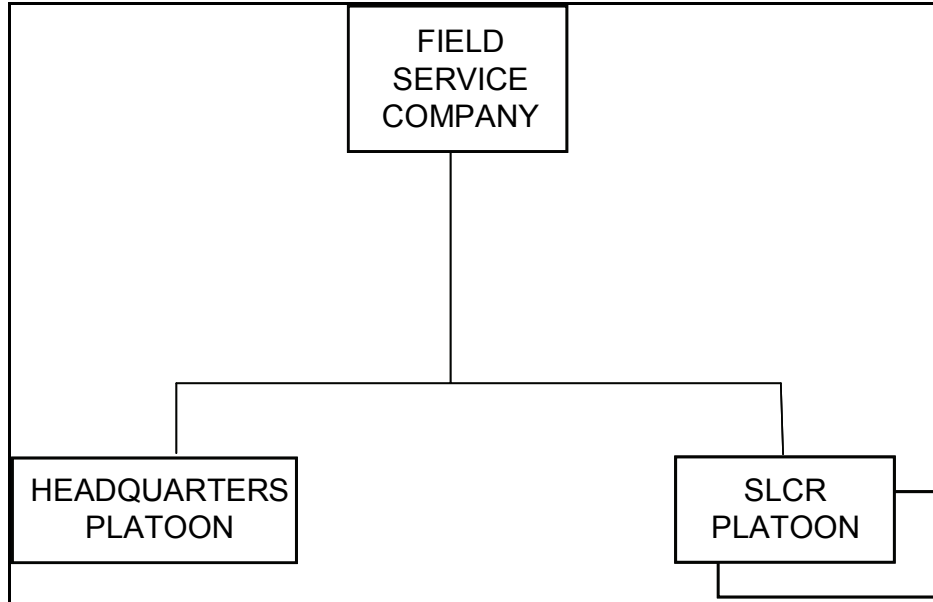

**Figure 4-23. Field Service Company**

## TRANSPORTATION

4-79. The mobility branch of the TSC SPO provides staff supervision of all transportation and coordinates directly with the MCB. The MCB is attached to the TSC/ESC and manages movement control across the entire theater of operations. The MCB would be attached to a sustainment brigade when the MCB is deployed to an AO in which the sustainment brigade is the highest sustainment C2 HQ. The MCB and its MCTs coordinate all movement in the JAO/AO to include all divisional areas.

4-80. Transportation expertise in the sustainment brigade is provided by the transportation branch of the distribution operations division. This section works with the other elements of the brigade SPO integrating movements with materiel management. The theater opening element, when assigned, augments the staff of a sustainment brigade and provides the technical expertise to open a theater of operations and establish the initial theater distribution network. The motor transportation battalion SPO receives technical supervision and guidance from the brigade SPO to support the theater distribution mission. Transportation assets of the CSSB and functional transportation battalions provide distribution from the sustainment brigades forward and retrograde of damaged or surplus items.

## MOVEMENT CONTROL

4-81. Movement control is the planning, routing, scheduling, controlling, coordination, and ITV of personnel, units, equipment, and supplies moving over multiple lines of communication. It involves synchronizing and integrating logistics efforts with other elements that span the spectrum of military operations.

4-82. The MCB will—

- Continue to provide command, control, and technical guidance to 4 to 10 MCTs.
- Provide asset visibility and maintain ITV of tactical and nontactical moves within its assigned geographical area (including unit moves and convoys).
- Assist in planning and executing plans and operations.
- Apply and meet movement priorities provided by the TSC and sustainment brigade.
- Support the entire spectrum of distribution.

The MCB will also coordinate with host nation authorities for cargo transfer locations, road clearances, border clearances, escort support, and transportation support. The MCB will have as many subordinate MCTs as needed to operate in its area of operations, based on the number of customers, air terminals, rail terminals, seaports, and MSRs it must support. The MCB will provide logistics support to the MCTs under its C2. However, MCTs operating away from their HQ will require logistics support from other units.

4-83. The MCT is the basic and most critical level in the movement control process. MCTs are the common point of contact for mode operators and users of transportation. The MCT is a 21-Soldier team created with the capability to perform every type of movement control mission. It is designed to provide maximum flexibility in its employment. Each team has a headquarters section and four identical subunits (or sections). The MCT can operate as a single team or separately at up to four different locations. For example, a single MCT can be deployed initially to provide movement control functions at an airfield while simultaneously providing cargo documentation. As the mission expands, the team can deploy a section onto the MSRs to conduct movement control operations. As the operation matures, that same MCT can operate at a second airfield or seaport. The operational use of the MCT can be specifically tailored to the mission and operational environment. The standardization of MCTs increases the number of teams available for deployment, since each unit is tailorable in the truest sense of that term. If METT-TC factors dictate that the MCT needs to be split into four sections in different locations, each section can be properly equipped with the vehicles, communications equipment, STAMIS, and generators it needs to operate independently.

4-84. MCTs process movement requests and arrange transport for moving personnel, equipment, and sustainment supplies. They process convoy clearance requests and special hauling permits. MCTs coordinate with the MCB for the optimal mode (air, rail, inland waterway, or highway) for unprogrammed moves and commit the mode operators from the sustainment brigade, LOGCAP, multinational elements, and the host nation. They also assist in carrying out the movement program. Figure 4-24 shows the surface transportation request process.

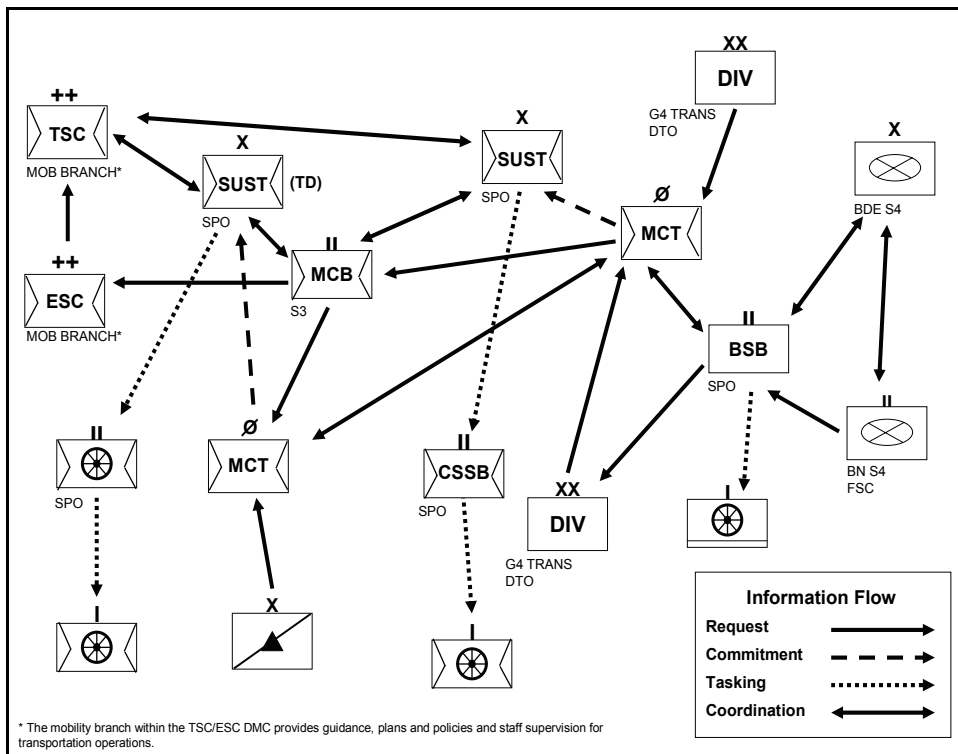

Figure 4-24. Surface Transportation Request Process

4-85. MCTs are arrayed on the battlefield at various nodes to best support the TSC concept of support. In general, a MCT collocates with a Sustainment Brigade to provide movement control support on an area basis to EAB units or units not assigned/attached to a Division. An additional MCT can work directly for the Division G-4 Transportation Officer (DTO) to assist in the planning and execution of movement control in the division area of operations. MCTs can operate at an APOD to facilitate the movement of ground cargo (primarily palletized), assist in passenger manifesting, and provide air load planning capability. MCTs operating at SPODs facilitate the ground movement of containerized cargo and assist in the marshalling/staging of equipment for onward movement. Elements of a MCT can locate at other critical nodes (for example Central Receiving and Shipping Point (CRSP), Convoy Support Center (CSC), TDC, and container yards, as needed) to provide cargo documentation capability or for the added visibility and management of distribution operations. MCTs are also used to enforce the highway regulation plan established by the TSC and will deploy its sections along Main Supply Routes (MSR) to augment convoy tracking operations and provide on the ground traffic deconfliction. For more information on movement control in a theater of operations refer to FM 4-01.30.

4-86. The sustainment brigade SPO distribution integration branch coordinates with the MCT, MCB, HN transportation agencies, transportation mode operators, and customers. This office assists in planning and executing plans for the reception, staging, onward movement, and retrograde of personnel, equipment, and sustainment supplies. This includes actions associated with marshaling and staging areas. When serving in a sustainment brigade that has the port mission, the distribution integration branch will have the responsibility to monitor, manage, and execute the movement and port clearance plans and programs. The branch also monitors the use of trailers, containers, and flat racks located in sustainment brigade AO and coordinates with users to expedite return of these assets to the transportation system.

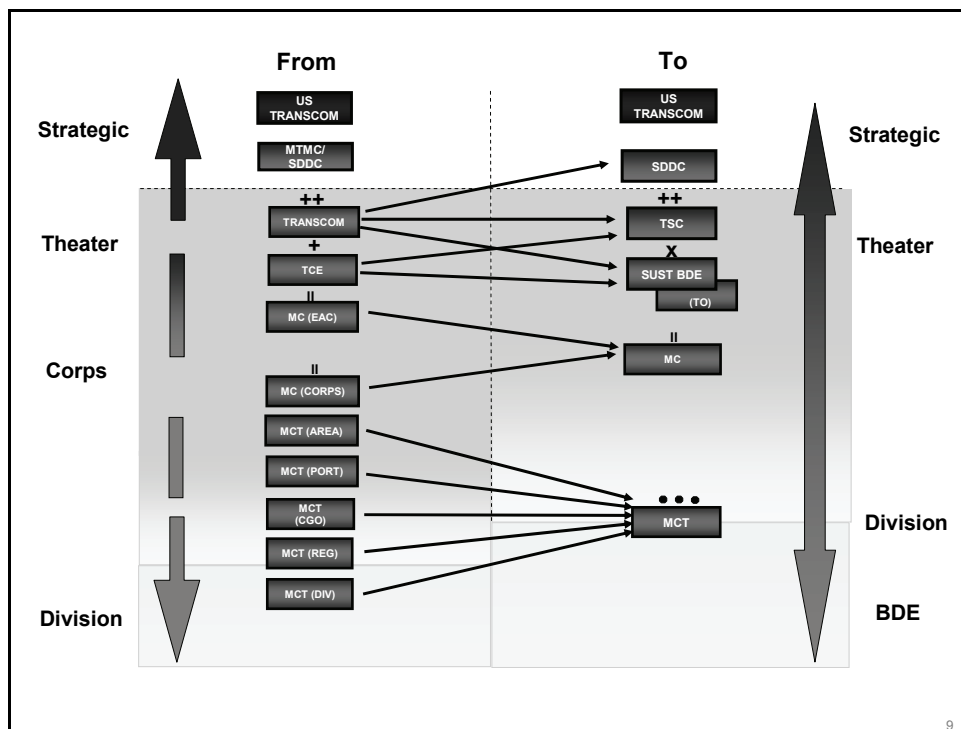

Figure 4-25. Modularity Movement Control Migration

### MOTOR TRANSPORT PLANNING

4-87. Motor transport planning, particularly in its early stages, must be based upon a set of broad planning factors and assumptions. These factors should be used only in the absence of specific data relating to the

current situation. Because of the different services performed, loads carried, and terrain crossed, caution should be exercised when analyzing the following factors:

- Task vehicle and driver availability rate.
- Vehicle payload capacity.
- Operational hours per shift.
- Operational day.
- Daily round trips.
- Operational distance per shift.
- Rate of march in the hour.
- Delay times.
- Threats and protection requirements.

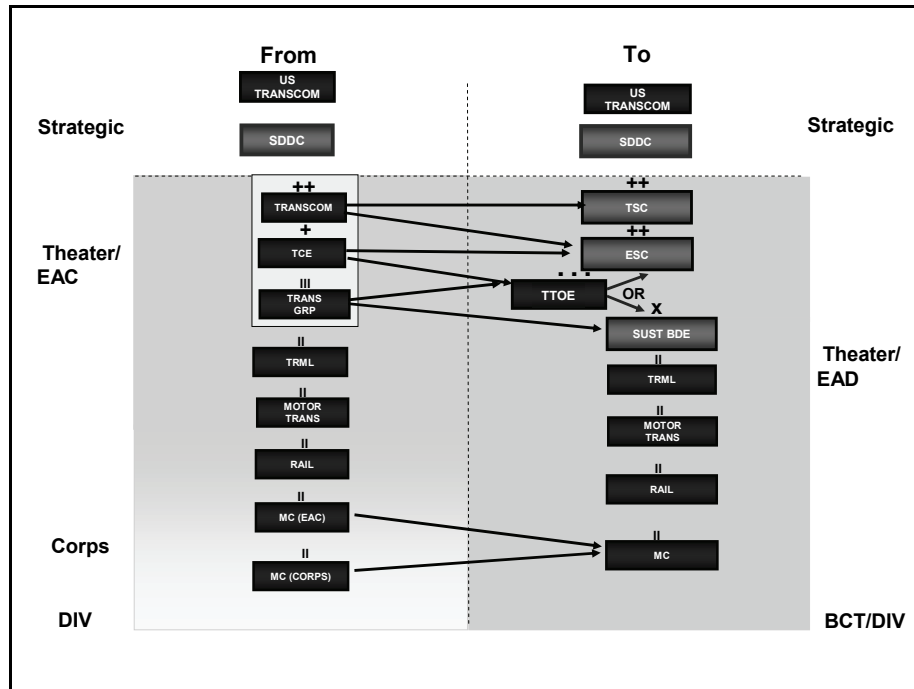

Figure 4-26. Modularity Transportation Management Migration

## CONTAINER MANAGEMENT

4-88. Recent history has shown that inter-modal operations are critically affected by the manner in which container management policies are enforced and container management is subsequently executed. Container management is a command function, not just a sustainment function. Due to the nature of container use, commanders at all echelons must be involved in container proper control. Therefore, a container management program must be established at a theater-level echelon that permits centralized management. For Army forces, the ASCC will provide further direction and control measures in order to maintain greatest discipline at the least cost. Sustainment brigade commanders must implement the theater management program for subordinate units.

4-89. Our industry partners will continue to use this method of packaging and distribution within the global environment for the foreseeable future; therefore, it is vital to maintain the control and flow of containers. Operations must fully integrate container management into the distribution system. Full-spectrum inter-modal distribution management capabilities include systems to maintain visibility, manage disposition at destination, and enable a rapid return to the distribution system to ensure adequate numbers

are available to maintain deployment, employment, sustainment, and retrograde operational pace. See AR 56-4 for more information on container management.

4-90. Successful container management ensures the following:

- Expedient movement of throughput and high-priority container shipments.
- Minimal time for holding and/or consolidating cargo.
- 100 percent in-transit visibility of containers and contents.
- Economical movements via container use.
- Movement of containers as fast as mode operators and consignees can handle them.
- Integration of military and commercial container management systems.
- Consolidation of single consignee shipments.
- Detention and demurrage reduction.
- Management of container availability to support retrograde movements.

### **Flatrack Management Operations**

4-91. Flatracks and containers offer tactical efficiencies that serve to increase the pace of sustainment operations. The key to these efficiencies and maintaining this pace is congruent flatrack/container management procedures at each stage or level of support (FSC, BSB, sustainment brigade, ESC, and TSC). An increased operational depth and the reduction of redundant logistics force structure challenge flatrack/container management and, ultimately, the sustainment of combat power. Flatrack/container employment, management, and retrograde operations are the responsibility of distribution managers. In the sustainment brigade, the support operations officer must track flatracks and containers dispersed throughout the distribution system within its operational span of control.

### **Logistics Support Area Flatrack Management**

4-92. Sustainment brigades operating a logistics support area (LSA) face increased flatrack management challenges especially when transportation assets to move supplies and retrograde flatracks are limited. Management responsibilities within the LSA rest with the support operations officer and the distribution division. Their responsibilities include:

- Identifying a flatrack collection point upon occupation of the LSA.
- Managing all common user flatracks on an area basis.
- Ensuring flatrack exchange (providing a back hauled flatrack for every one received) procedures are adhered to as a matter of priority.
- Maximizing the use of PLS/HEMMT-LHS platforms for retrograding flatracks from the flatrack collection point back into the distribution system.
- Reporting flatrack on-hand quantity by location, status, and condition to the flat-rack control office established by the senior manager in theater of operations (in accordance with AR 710-2, Inventory Management Supply Policy Below the National Level).
- Coordinating with the servicing MCB for supplemental transportation support when retrograding flatracks from the LSA flatrack collection point (FRCP).

4-93. Flatrack exchange is the preferred method for retrograding flatracks. FRCPs outside of the LSA are designated for flatrack consolidation purposes when required and these proposed locations are reported to the distribution division.

### **Flatrack Reporting Procedures**

4-94. Accurate daily reporting of flatracks in a unit's area of operations by location, status, and condition is critical to efficient management of these assets within the distribution system. Separate reports may not be required for reporting flatrack status, since distribution managers may roll flatrack status into existing reports. Requests for supplemental transportation to retrograde flatracks in the operational area are submitted as routine transportation requests through support operations channels. Flatrack procedures

outlined in this chapter should be reinforced and clarified with unit tactical standing operating procedures (TACSOPs).

## **AERIAL DELIVERY**

4-95. Aerial delivery consists of Service fixed-wing, rotary-wing and, in some cases Unmanned Aircraft Systems (UASs), conducting air-land, airdrop, and sling-load cargo operations. It supports the sustainment requirements of combat units on a noncontiguous AO with extended LOCs, reducing the amount of traffic on major ground supply routes. Aerial delivery capability requirements include—

- Providing operational planning and task execution supervision for all aerial delivery operations.
- Receiving, classifying, and performing field level maintenance of all air item equipment.
- Requisitioning, receiving, inspecting, storing, and issuing air item equipment.
- Packing and rigging supplies and equipment for forward, lateral, and retrograde distribution.
- Packing personnel and cargo parachutes and temporarily storage of rigging air item supplies and equipment for use by the Army, Air Force, or other Services.
- Providing personnel and cargo parachute supplies, parachute packing, and field level maintenance of air item supplies and equipment; along with rapid rigging and de-rigging of cargo air transport equipment.

4-96. Air-land operations provide for greatest cargo tonnage movement and are conducted routinely on an inter-theater basis. Using this method, air carriers normally terminate at a relatively secure APOD, physically descending, landing, and spending time on the ground to off-load. In doing so, supplies and equipment are normally introduced to the ground for onward movement and distribution. Continued, intra-theater, air-land movement to forward austere airfields commonly restricts the use of fixed-wing aircraft due to threat capabilities, necessary airfield preparation, and off-load capabilities. When continued intra-theater, air-land operations are conducted, rotary-wing assets conducting internal cargo carrying operations are normally employed. However, use of rotary-wing aerial delivery platforms can present range limitations.

4-97. Airdrop permits throughput of supplies from as far rearward as the National level, directly to the using unit, and reduces the need for forward airfields, landing zones, and materiel handling equipment, effectively reducing the forward battlefield footprint, as well as mitigating the enemy threat to traditional surface methods of distribution. Airdrop provides the capability to supply the force, even when land lines of communication have been disrupted, adding flexibility to the distribution system. New aerial delivery platforms increase the flexibility and responsiveness to move supplies quickly and precisely to a BSB or throughput to a maneuver unit from a sustainment base. Certain contingencies may require airdrop re-supply support from the beginning of hostilities. However, the requisite airdrop support structure may not be in a theater of operations due to deployment priorities. In such cases, the strategic-level commander should consider having a portion of the supporting airdrop supply company deploy to designated APOEs responding to the deployment and where supply support to the contingency area is more abundant. This might include airdrop capability at Intermediate Staging Bases, Depots, and DLA locations. When in-theater, airdrop supply companies, functioning as part of the Sustainment Brigade, should be located at major transportation, supply and distribution hubs with capable airfields. Such hubs should also include depot and DLA sites, where supplies may be rigged or pre-rigged and readily available for tasked aircraft. Using the range and speed of air carriers, forces then fly intra-theater airdrop missions, supplying directly to the airdrop location and then returning to a transportation hub.

4-98. Air-drop operations provide for the ability to supply and distribute cargo, using parachutes and platforms to release supplies and equipment from an aircraft while in flight. When conducted in range, this method of aerial delivery requires no descent or landing deep in a combat area or remote area. Recent changes, innovations, and technology applications have revived the air-drop method, producing both high and low altitude release capabilities. These changes provide air carriers significantly increased survivability as they are able to avoid traditional, mid-level airspace release where threat weaponry is now most prominent. While still considered niche capability, the air-drop method offers significant growth potential as it supports numerous non-traditional users and has many employment applications.



4-99. Innovations in air drop methods will allow for support from greater distances and from high altitude with significantly increased on-ground accuracies. An autonomously guided, precision airdrop system, employed from high altitudes and offset from drop zones can deliver critical warfighting supplies to within 150 meters or better of its planned ground location. Low altitude airdrop improvements provide for increased on-ground accuracy and greatly reduced airdrop equipment costs.

4-100. New aerial delivery platforms are being developed to give the flexibility and responsiveness to move certain supplies quickly and precisely to a BSB or throughput to a maneuver unit. Aerial delivery also reduces the amount of resupply convoys. The sustainment brigade may be task organized with Quartermaster aerial resupply companies that would prepare platforms for air-drop, air-land, or sling load mission. ILAR, which consists of Air Land, Airdrop, and Helicopter Sling load operations, is an integral and an increasingly critical component of theater distribution and sustainment operations. By design and intent, ILAR will be conducted in balance and in synchronization with surface distribution operations to ensure that Army units and joint combatant commanders have the aerial resupply capabilities and enablers needed to meet operational requirements in the conduct of Full Spectrum Operations. The sustainment brigade may be task organized with Quartermaster aerial resupply companies that will be required to plan and execute ILAR operations. Using a combination of surface and aerial delivery assets, the sustainment brigade will be responsible for providing a fully integrated and synchronized aerial resupply capability, which ensures effective, efficient, and responsive support and services; takes advantage of joint intermodal enablers; and is transparent to but fully supportive of our joint combatant commanders and the operational needs of our forces. New and innovative joint aerial resupply platforms; aerial resupply aircraft (fixed wing, rotary wing, and unmanned aircraft systems); modular packaging and containers; configured loads; aerial delivery systems, such as Joint Precision Airdrop and Low-Cost, Low-Altitude Aerial resupply systems; and evolving state-of-the-art technologies are being developed and fielded to meet the full spectrum of operational and support requirements. Properly implemented and synchronized with surface distribution assets, ILAR will effectively reduce the number of convoys, expedite the distribution of supplies, and of special significance, greatly enhance protection.

4-101. Rotorcraft sling loading provides for rapid movement of heavy, outsized cargo directly to the user, bypassing surface obstacles. This provides greater responsiveness and flexibility to the ground commander by reducing planning cycle time. It also allows the use of multiple flight routes and landing sites, which enhance survivability of the aircraft and crew. Rotorcraft are highly flexible, forward positioned, aerial delivery platforms. Operationally, they are able to perform missions surrounding all three methods of aerial delivery in support of Full Spectrum Operations.

4-102. The increased use of UASs as a supply distribution platform is of growing importance. UASs are currently designed to be application specific and are weight limited. There are still employment opportunities to provide lighter, but critically needed supplies, to a broad range of customers and low cost. Disposable UASs are being examined in the Science and technology base.

4-103. Integrating logistics aerial re-supply with emerging enablers and commercial business practices raises aerial delivery to the next higher level. This capability synchronizes doctrine, organization, training, materiel, leadership and education, personnel, and facilities (DOTMLPF) solutions to improve aerial re-supply operations for current forces. It leverages all aerial delivery platforms and techniques available in the most advantageous combination to provide both inter- and intra-theater supply support and is a key component of Theater Distribution. This aerial re-supply capability, when conducted in balance and synchronization with surface distribution operations, better ensures the Geographic Combatant Commander a more robust menu of movement options and enablers necessary for meeting the requirements of Full Spectrum Operations. This capability includes developing a low cost air drop system for use in supporting humanitarian assistance operations or when recovery is not likely; creating a suite of precision cargo airdrop systems that can be used to support various weight categories and mission scenarios maximizing the cargo airdrop capability of the C-17 and future aircraft; designing a way to safely jettison aboard aircraft; and, streamlining the aerial delivery request processes to enable timely support to the Soldier. In addition, developing a low velocity cargo airdrop system that can operate at 500 feet or less, will increase delivery accuracy, which permits the use of much smaller drop zones and reduced load dispersion on the demilitarized zone. The total effect of an integrated logistics aerial re-supply system will be to enhance

operational response, improve load survivability, reduce the logistics footprint, and significantly improve protection.

### MOVEMENT CONTROL BATTALION (MCB)

4-104. The MCB commands and controls between four and ten movement control teams (MCTs), provides technical supervision, and coordinates the use of common user transportation assets theater-wide. The MCB also provides visibility of unit moves, convoy movements, and operational moves. The MCB is assigned to the TSC and accountable for the execution of the movement program and performance of the theater transportation system. In the current force, an MCB will be under the TACON or administrative control (ADCON) of a sustainment brigade when the sustainment brigade is the senior sustainment HQ in an AO. Figure 4-27 shows the organizational structure of a MCB HQs.

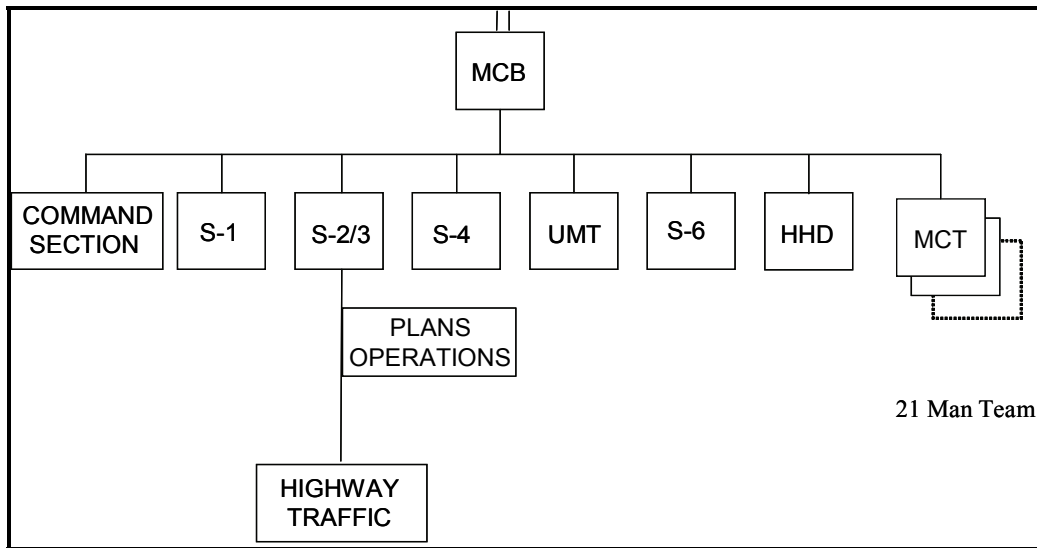

Figure 4-27. Movement Control Battalion Headquarters

### Movement Control Teams (MCT)

4-105. The MCT is the lynchpin of the Movement Control System. At least one will normally be collocated with the sustainment brigade to support brigade operations. Elements of an MCT may also collocate with operational area under the command of a sustainment brigade such as ports or convoy support centers. An MCT is a 21-person team with the capability to perform every type of movement control mission on a 24-hour basis. It is designed to provide maximum flexibility in its employment. Each team has a headquarters section and four identical sub-units (or sections). The MCT is capable of operating as a single team or separately at up to four different locations. The MCT is capable of conducting the following missions:

- Coordinate transportation support, highway clearance, and inbound clearance for moving units, personnel, and cargo.
- Coordinate transportation movements, diversions, re-consignments, and transfers of units, cargo, and personnel.
- Provide technical expertise to transportation users within its assigned area of responsibility.
- Provide ITV of unit equipment and sustainment cargo movements in an assigned area of responsibility.
- Observe, assess, and report on the progress of tactical and nontactical transportation movements along MSR or alternate supply routes and through critical nodes.
- Adjust movement schedules as necessary to coordinate the movement of authorized traffic.

- Provide first destination reporting points.
- Provide as many as four sub-units to four separate locations, each performing a different aspect of movement control.
- Commit transportation assets.

## MOTOR TRANSPORTATION BATTALION

4-106. The mission of the motor transportation battalion (see Figure 4-28) is to command, control, and supervise units conducting motor transport operations and terminal operations (less seaport). Motor transportation battalions are typically assigned to the TSC upon arrival into a theater of operations, and are further attached to a Sustainment Brigade. Its core capabilities are providing C2 and technical supervision for three to seven motor transport or cargo transfer companies. The battalion plans and schedules requirements to conform to the overall movement program. The staff—

- Translates transportation requirements from higher HQs into specific vehicle or unit requirements.
- Evaluates highway traffic plans affecting road movement, to include terrain, road conditions, and security.
- Supervises the operation of truck terminals, trailer transfer points, and/or a trailer relay system.
- Coordinates for host nation support as available.

The motor transportation battalion SPO receives guidance and technical direction from the sustainment brigade SPO when analyzing requirements and planning for transportation operations.

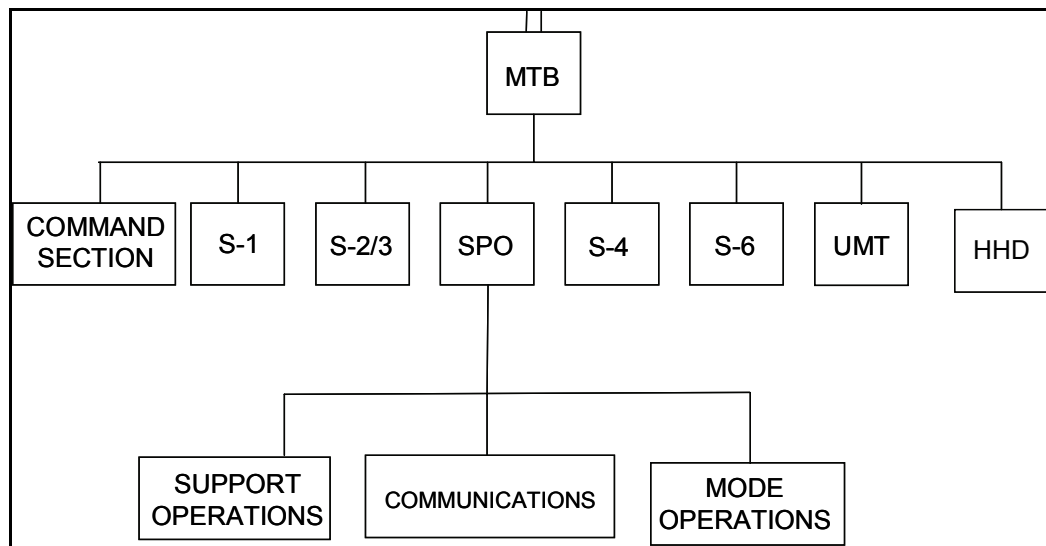

Figure 4-28. Motor Transportation Battalion Headquarters

## TRANSPORTATION TERMINAL BATTALION

4-107. The mission of the Transportation Terminal Battalion (see Figure 4-29) is to command, control, and supervise units conducting terminal operations. Transportation Terminal Battalions are typically assigned to the TSC upon arrival into a theater of operations and are further attached to a Sustainment Brigade. Terminal operations include truck, rail, air, as well as marine terminals and ports. Its core capabilities are providing C2 and technical supervision for three to seven terminal operations and/or watercraft companies. The battalion plans and schedules requirements to coincide with the strategic and operational distribution and movement programs. The objective is to balance the flow of materiel and personnel from strategic transportation modes with the ability of the operational providers to clear the

terminal or port. Achieving this is paramount to keeping the ports of debarkation uncongested and units, personnel, and supplies flowing smoothly into and out of a theater of operations. The staff—

- Translates transportation requirements from higher HQs into specific vessel discharge and terminal/port clearance schedules.
- Evaluates terminal and port facilities for usability.
- Evaluates ingress and egress routes and highway traffic plans affecting road movement, to include terrain, road conditions, and security.
- Supervises the operation of truck, rail, air and marine terminals.
- Coordinates for host nation support as available.

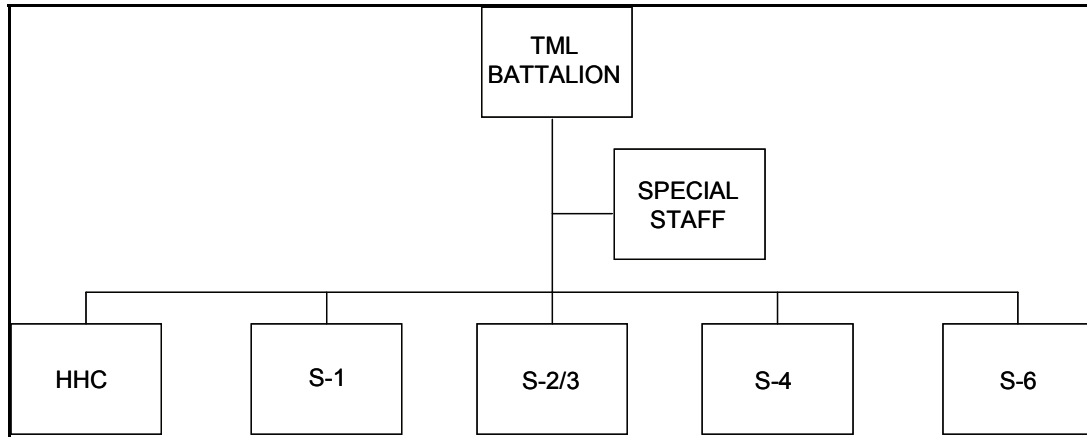

Figure 4-29. Transportation Terminal Battalion

## TRANSPORTATION COMPANIES

4-108. Transportation companies provide lift capability for both the operational and tactical sustainment mission of the sustainment brigade. Truck companies move personnel and materiel throughout the distribution system, while cargo transfer and terminal companies provide capabilities essential to the theater opening, port operations, and hub operations. Transportation companies are typically assigned to the CSSB or functional transportation battalions that are attached to sustainment brigades. This section of the chapter identifies various transportation companies that might be attached to a sustainment brigade and provides information on general capabilities of each company.

### Truck Companies

4-109. Truck companies provide transportation for the movement of break-bulk cargo, containers, bulk water, POL, preconfigured loads on flatracks, heavy lift combat systems, and personnel by motor transport. Trucks generally move along designated supply routes in convoys, which are groups of vehicles moving from the same origin to a common destination and organized under a single commander for the purpose of control.

4-110. There are three basic types of truck companies: light-medium, medium, and heavy. As the name implies, light-medium truck companies (see Figure 4-30) have two types of vehicles with which to provide transportation support from the Family of Medium Tactical Vehicles (FMTV), a series of vehicles based on a common chassis that vary by payload and mission requirements. The Light Medium Tactical Vehicle (LMTV) has a 2.5-ton capacity (cargo and van models), while the Medium Tactical Vehicle (MTV) has a 5-ton capacity (cargo and long-wheelbase cargo with and without materiel handling equipment, tractor, van, wrecker, and dump truck models). Three truck variants and two companion trailers with the same cube and payload capacity as their prime movers provide air drop capability.

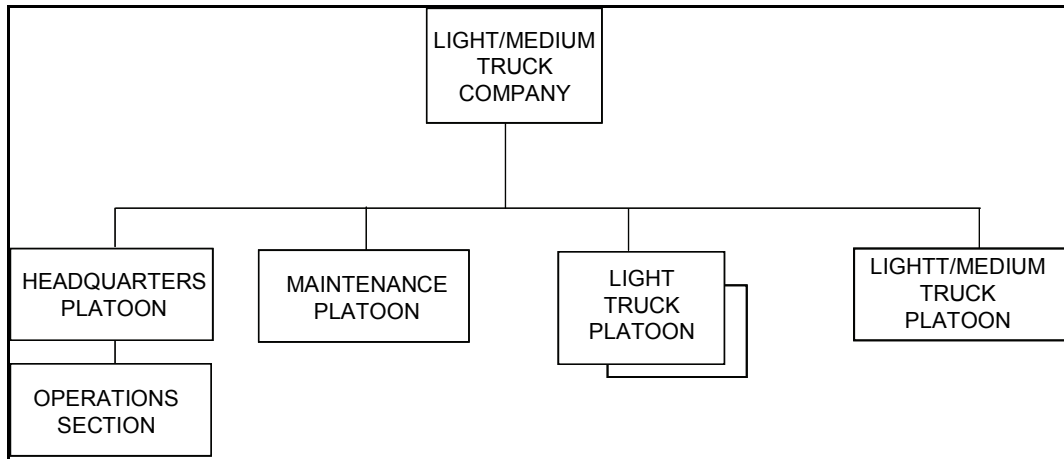

**Figure 4-30. Light-medium Truck Company**

4-111. On a 24-hour basis, the Light-Medium Truck Company can provide up to 43, 5-ton cargo trucks for transport missions and 8 tactical tractor-semi-trailer combinations for transport missions. It has a one time lift capability as follows:

- Breakbulk General Cargo 190 STONS
- Breakbulk Ammunition 342 STONS
- Pallets 370
- 463L Pallets 67
- Containers, Twenty foot (TEU) 8

4-112. The FMTV performs local and line haul, unit mobility, unit resupply, and other missions in combat and logistics units. It is rapidly deployable worldwide and operates on primary and secondary roads, trails, and cross-country terrain in all climatic conditions. Commonality of parts across varied truck chassis significantly reduces the logistics burden and operating and support costs.

4-113. Medium truck companies (see Figure 4-31) have some variant of the M915A3 Line Haul Tractor, which tows the M872 34-ton flatbed trailer, M967 5,000-gallon bulk fuel tanker, and M1062 7,500-gallon bulk fuel trailer; or the PLS truck. PLS trucks have a self-load/off-load capability with demountable cargo bed (CROP), a central tire inflation system to enhance mobility, and are air transportable via C-5, C-130 and C-17, as well as deployable by rail and sea. CROP is NATO-interoperable and fits inside a single ISO container. The PLS container handling unit transports ISO containers.

4-114. On a 24-hour basis, the Medium Truck Company Cargo provides up to 52 trucks for mission operations and has a one time lift capability as follows:

- Breakbulk General Cargo 395 STONS
- Breakbulk Ammunition 709 STONS
- Pallets 1060
- 463L Pallets 212
- Containers, Twenty foot (TEU) 106
- Containers, Forty foot (FEU) 53
- Water 242,210 GALS

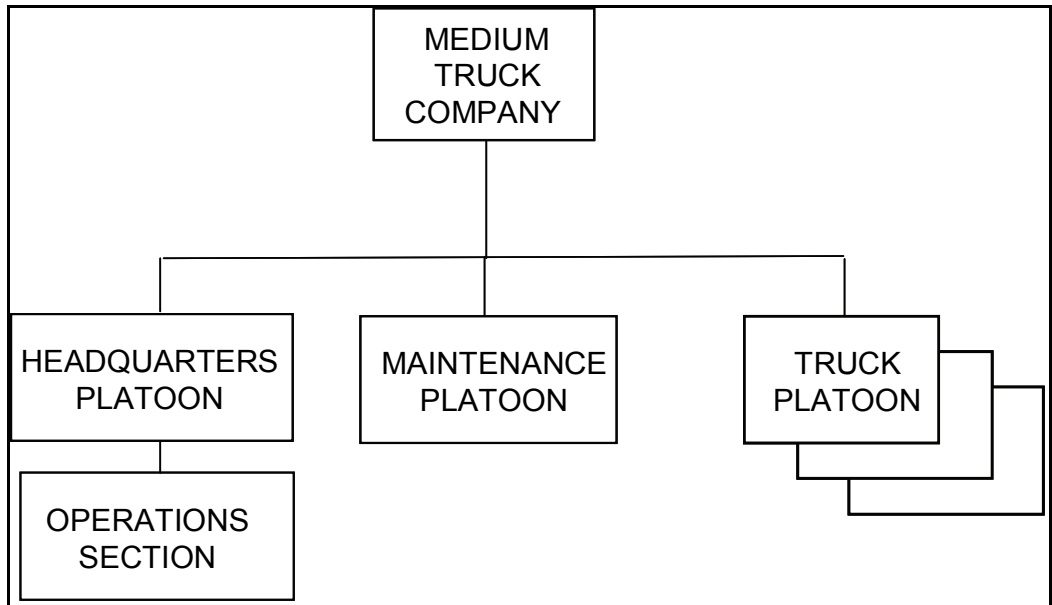

**Figure 4-31. Medium Truck Company**

4-115. On a 24-hour basis, the Transportation POL Truck Company (7.5K Theater) provides up to 53 trucks for mission operations and has a one time lift capability for bulk fuel of 371,000 gallons.

4-116. On a 24-hour basis, the Transportation POL Truck Company (5K Theater) provides up to 53 trucks for mission operations and has a one time lift capability of 238,500 gallons of bulk fuel.

4-117. With a 84.7 percent task vehicle availability rate, operating on a two-shift basis, and making four round trips per day (two per operating shift) in local hauls or two round trips (one per operating shift) in line hauls, the Transportation Medium Truck Company (Cargo) Corps provides:

	<u>CARGOHAULS</u>	<u>LOCAL LINE HAULS</u>
CONTAINERS (Dry/Refrigerated)	203	102
NONCONTAINERIZED (Palletized/Packaged)	974 STONS	487 STONS
WATER	304,920 GAL	609,840 GAL

4-118. With a 84.7 percent task vehicle availability; this unit, operating on a two-shift basis, and making four round-trips per day (two per operating shift) in local hauls or two round trips (one per operating shift) in line hauls, the Transportation Medium Truck Company (POL) is capable of transporting the 1,016,400 gallons of petroleum in local hauls and 508,200 gallons of petroleum in line hauls.

4-119. On a 24-hour basis, the Transportation PLS Truck Company provides up to 53 trucks for mission operations and has a one time lift capability as follows:

- Breakbulk General Cargo 379 STONS
- Breakbulk Ammunition 681 STONS
- Pallets 864
- 463L Pallets 216
- Containers, Twenty foot (TEU) 108
- Containers, Forty foot (FEU) 0
- Bulk Water 216,000 GALS (must be equipped with HIPPO)
- Bulk Fuel 270,000 GALS (must be equipped with POL Tank racks)

4-120. The Transportation Combat Heavy Equipment Transport Company (see Figure 4-32) can provide a one-time lift of 86 tracked combat vehicles (one tracked vehicle per heavy equipment transport [HET]). Six of these units operating simultaneously, can relocate a brigade size heavy maneuver force.

4-121. Management and visibility of limited heavy equipment transport systems (HETS) (see Figure 4-23), which consist of the M1070 Truck Tractor and the M1000 Heavy Equipment Transporter Semi-trailer, are particularly critical when supporting a heavy force. HETs transport payloads up to 70 tons – primarily Abrams tanks. Maneuver commanders rely heavily on the capabilities the combat HET Company brings to an operation: transport, recovery, and evacuation of combat-loaded main battle tanks and other heavy tracked and wheeled vehicles to and from the battlefield.

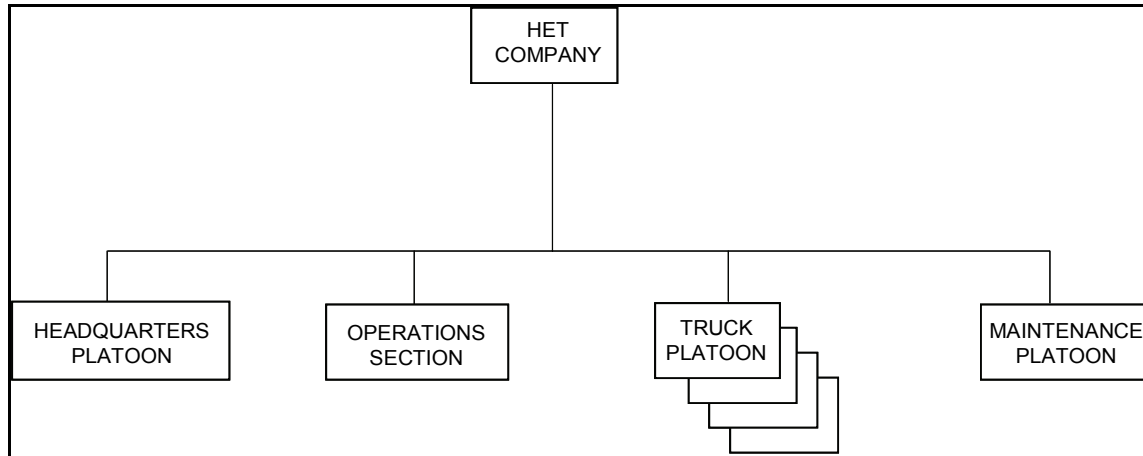

**Figure 4-32. Combat HET Company**

## MARINE/TERMINAL TRANSPORTATION COMPANIES

4-122. The Sustainment Brigade may require watercraft and terminal units to execute its mission. The type and quantity of units required will be METT-TC dependent and take into account several factors to include the type and scale of the sustainment brigade's mission and the availability of host nation or commercial assets.

4-123. Army marine and terminal units manage and execute port or inland terminal operations services. They can administer and supervise contracts for stevedore and related terminal services, inland waterway, and highway/rail transport operations in support of port or terminal reception and clearance activities. Transportation Terminal Battalions attached to the sustainment brigade provide C2, planning, and supervision of attached units employed in the operation of terminals. Cargo transfer operations are simply the removal of cargo and materiel from one mode of transport and placing it on another mode for continued movement. The two main units that provide this capability to the Army are the Seaport Operations Company and the Inland Cargo Transfer Company (ICTC). These two companies may be assigned to a CSSB or functional battalion to perform intermodal operations at a seaport or at APODs and distribution hubs or terminals respectively.

4-124. Augmentation elements like the automated cargo documentation team provide automated documentation support for cargo discharged from ships. Port Management Teams (PMT) provide contract supervision and management for contracted execution or augmentation of port operations. Terminal Management Teams provide management of all or part of a port operation and works in coordination with the PMT.

4-125. Beaches ideally suited for LOTS without prior preparation or alteration are rare. Therefore, some engineering support is normally required to enable landing craft to beach and to provide exits from the beach to marshaling areas and the clearance transportation network. This capability is beyond the units depicted below.

### Heavy Watercraft Company

4-126. The heavy watercraft company's (see Figure 4-33) mission is to perform waterborne transportation of personnel, cargo, and equipment during intratheater lift, water terminal, waterborne tactical and joint amphibious, riverine, or LOTS operations. It is normally assigned to a sustainment brigade for theater opening. Its capabilities are to--

- On a 24-hour basis, provide up to eight landing craft (LCU 2000) for transport missions.
- Move five M-1 main battle tanks or twenty-four 20-foot containers with each LCU 2000.
- Transport 2,800 STON of cargo consisting of vehicles, containers, and/or general cargo.
- Self-deploy tasked vessels when this unit is equipped with LCU 2000s.

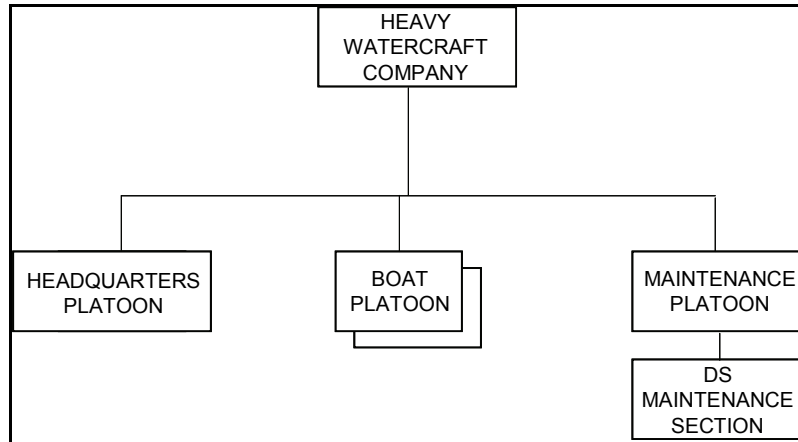

Figure 4-33. Heavy Watercraft Company

### Medium Boat Detachment

4-127. The mission of the Medium Boat Detachment (see Figure 4-34) is to perform waterborne transport of personnel, cargo, and equipment during water terminal, waterborne tactical, and joint amphibious, riverine, or LOTS operations. It is currently equipped with the seven LCM-8s (MOD 1) and two LCM-8s (MOD 2). The unit is normally assigned to a TSC and attached to either a Transportation Terminal Battalion or CSSB conduction marine terminal operations. At full strength the unit can--

- Transport an average of 1,000 STONs of non-containerized cargo based on an average of 42 STONs per landing craft each making two trips a day.
- Transporting 240 20-foot containers per day based on one container per landing craft each making 20 trips per day.
- Transport 2400 combat equipped Soldiers in one lift.

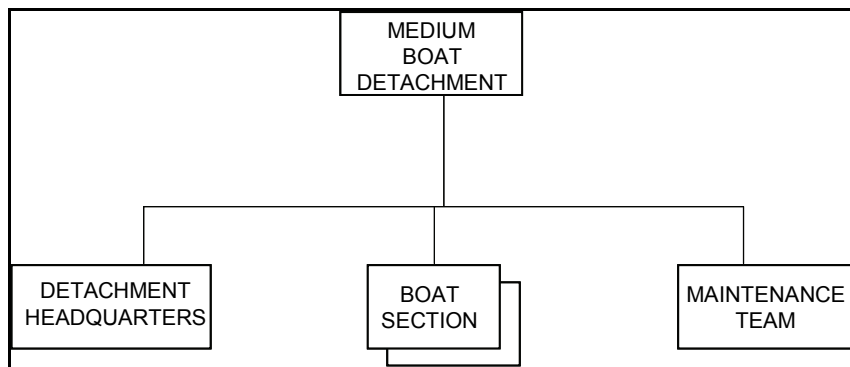

Figure 4-34. Medium Boat Detachment



### Seaport Operations Company

4-128. The seaport operations company's (see Figure 4-35) mission is to perform seaport terminal service operations to discharge and load containerized cargo and wheeled/tracked vehicles in fixed seaports or in LOTS sites. It is normally assigned to a port or JLOTS complex operating under the TSC or a sustainment brigade conducting theater opening. Its capabilities include:

- In a fixed port: discharge or load up to 375 containers, 750 wheeled/tracked vehicles, or 1,875 STONs of break-bulk cargo per day.
- In a LOTS operation: discharge or load up to 150 containers, or 750 STONs of break-bulk cargo, or 450 wheeled/tracked vehicles per day.

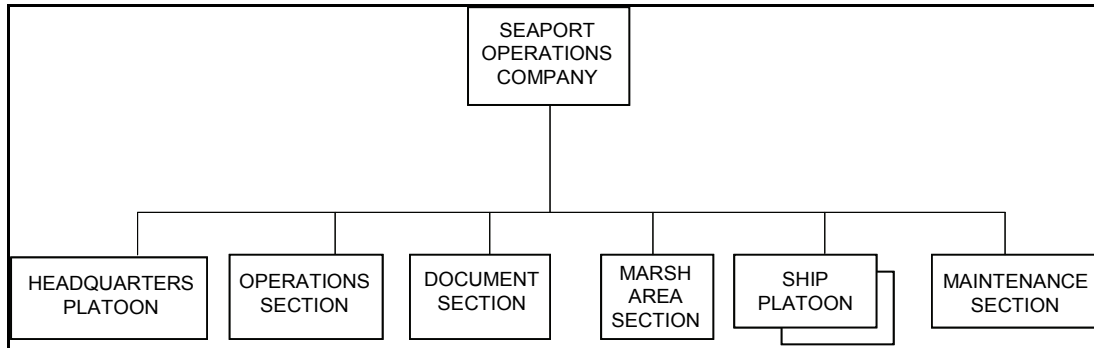

**Figure 4-35. Seaport Operations Company**

### Modular Causeway Company

4-129. The modular causeway company's (see Figure 4-36) mission is to provide movement support for cargo and equipment during intra-theater lift, water terminal, waterborne tactical and joint amphibious, riverine, and JLOTS operations. It is normally assigned to a port or JLOTS complex operated by a transportation terminal battalion, but may be attached to the US Navy or US Marine Corps to support joint amphibious, riverine, or JLOTS operations. Several variants of causeway sections can be configured to meet mission needs. C2 is provided by a transportation battalion subordinate to a sustainment brigade. Its organic elements have the following characteristics and capabilities:

- **Floating Causeway Pier.** Consists of 1 to 17 non-powered causeway sections (CSNP) [up to 1,200 feet in length], with a dry bridge for the discharge of cargo and equipment from landing craft directly to an unimproved shoreline or degraded fixed port facility.
- **Causeway Ferry.** Consists of one powered causeway section (CSP) and up to three CSNPs for moving rolling stock, break bulk, containerized cargo from ship to shore.
- **Roll-On/Roll-Off Discharge Platforms.** Consists of up to 18 CSNPs that interface between roll on/roll off (RO/RO) ships and lighters for the rapid discharge of rolling stock.

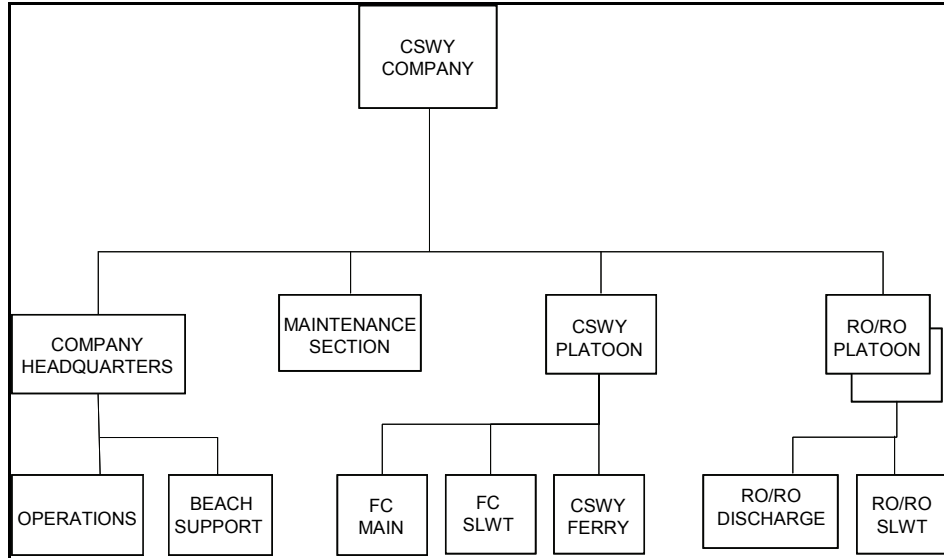

Figure 4-36. Modular Causeway Company

### Floating Craft Company

4-130. The mission of the floating craft company (see Figure 4-37) is to perform floating craft and harborcraft operations during intratheater lift; water terminal; waterborne tactical; and joint amphibious, riverine, or JLOTS operations. This company is normally assigned to a port or JLOTS complex operated by a transportation terminal battalion subordinate to a sustainment brigade. Its organic elements have the following capabilities:

- **Large Tug.** Performs ocean and coastal towing, salvage, and recovery operations, general purpose harbor duties, and firefighting service.
- **Small Tugs.** Performs tug services in support of water terminal and inland waterway operations.
- **Floating Crane.** Loads and discharges heavy lift cargo that is beyond the capacity of a ship's gear.
- **Barges.** Transport up to 324 STONs of deck-loaded dry cargo or 93,000 gallons of bulk fuel. Capable of serving as a refueling point for Army watercraft operating in the area.

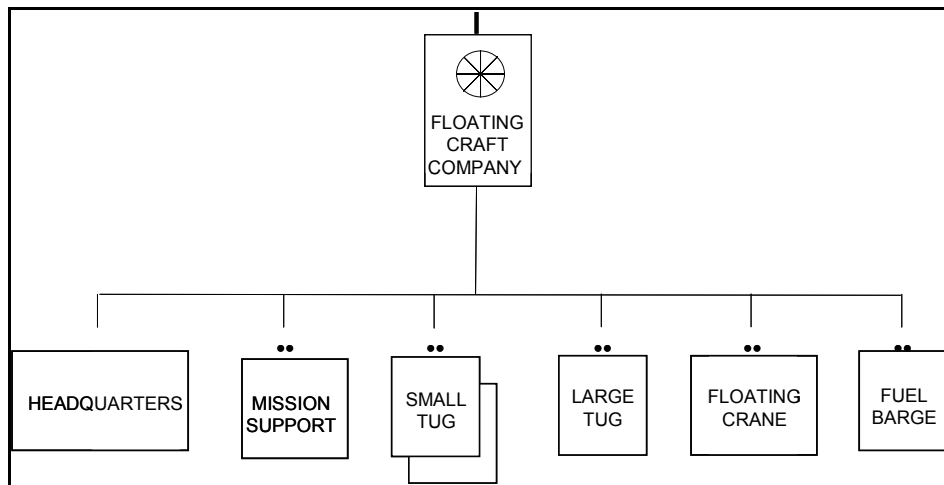

Figure 4-37. Floating Craft Company

### Logistics Support Vessel (LSV) Detachment

4-131. The LSV detachment and the LSV with its full crew compliment should be considered synonymous; the detachment is the vessel and its crew. The mission of the LSV Detachment is to—

- Provide transportation for vehicles, containers, and/or general cargo to remote, underdeveloped areas along coastlines and Inland Waterways.
- Support unit deployments, relocations, and port to port operations.
- Assist in discharging and back-loading ships in a RO/RO or lots operation.
- Provide cargo transportation along coastal main supply routes (MSRs).

The Detachment is capable of self-sustainment for a period of 30 to 45 days with accommodations for a 31-member crew. The unit is assigned to a TSC and can be attached to a Sustainment Brigade with a requirement to provide intra-theater lift assets or to a Transportation Terminal Battalion or CSSB conducting marine terminal operations. The vessel is capable of self-delivery to a Theater of Operations and meets the requirement to transit the Panama and Suez Canals. The LSV can transport 2,000 STONS of cargo, consisting of vehicles, containers, and/or general cargo.

### Inland Cargo Transportation Company (ICTC)

4-132. The ICTC's (see Figure 4-38) mission is to discharge, load, and transship cargo at air, rail, or truck terminals; to supplement cargo/supply handling operations to alleviate cargo backlogs; to operate cargo marshalling area as required. The ICTC can also perform the functions of an arrival/departure airfield control group (A/DACG). Normally assigned to a sustainment brigade conducting theater opening or theater distribution, this unit's capabilities are to operate rail, truck, or air terminals on a 24-hour per day basis and to operate intermodal terminals in a theater hub or TDC. The ICTC can accomplish the following:

- In rail intermodal or truck terminal operations, transship 2,400 STONs of break-bulk cargo or 600 containers.
- In air terminal operations, transship 1,500 STONs of break-bulk cargo or 600 containers.
- At inland terminals, it can perpetuate cargo documentation and re-document diverted or reconsigned cargo.
- During container operations, the unit can stuff and unstuff containers. However, this capability degrades other capabilities.

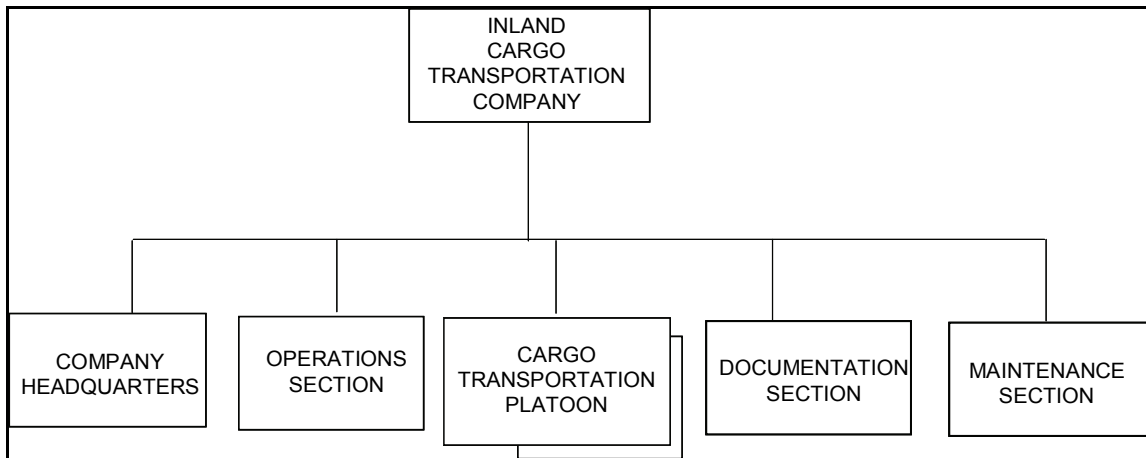

Figure 4-38. Inland Cargo Transfer Company

### **Arrival/Departure Airfield Control Group**

4-133. The arrival/departure airfield control group (A/DACG) is an ad hoc organization provided by the supporting installation and is designed to assist AMC and the deploying unit in receiving, processing, and loading personnel and equipment. Its composition is mission dependent but cargo transfer companies are best suited for the role. In CONUS, the A/DACG is a shared responsibility between Installation Management Command installations and FORSCOM units.

### **Port Support Activity**

4-134. The port support activity (PSA) is an ad hoc support organization designed to assist SDDC with the loading or discharge of cargo, vehicles, and equipment at seaports. The PSA coordinates offload of units and equipment with the sustainment brigade to ensure onward movement and RSOI support. Normally SDDC verifies the resources required and provides them from their own resources or contracts for them. SDDC may also request additional PSA support from the sustainment brigade supporting the theater base. However, unit support requests beyond standard port operations (aircraft assembly/disassembly, convoy reception) are the responsibility of the requestor. The PSA is operationally controlled by the military port or transportation terminal battalions/brigades (TTB) commander. The TTB are US Army Reserve units assigned to SDDC.

### **CENTRALIZED RECEIVING AND SHIPPING POINT**

4-135. A Centralized Receiving and Shipping Point (CRSP) is a dock-to-dock distribution center using the hub and spoke method of efficiently delivering cargo. Generally, cargo is not warehoused at a CRSP, with the common holding period being 24 hours or less. The objective is to move cargo as quickly and efficiently as possible, the exception being frustrated cargo, cargo destined to low volume consignees, or battle damaged equipment which might require inspection and processing. Although traditional use of CRSPs was for container handling only, the mission was expanded to great advantage during Operation Iraqi Freedom. Use of CRSP operations reduced transit times and provided greater security as the convoy operators were more familiar with assigned terrain and threats than in-theater personnel who had previously been performing the convoy operations all the way to the tactical level. Under the CRSP concept, theater convoys deliver to a CRSP(s) with CSSBs operating convoys delivering to the consignee, forward operating base (FOB), or other CRSP. Each CRSP would arrange for backhaul both from the FOBs to the CRSP and from the CRSP to the theater-level supply units. Convoys should pick up all retrograde cargo from a FOB, regardless of whether or not the consignee is part of the CRSP's network as it is easier for the CRSP to use the CRSP network to trans-ship the retrograde to the appropriate CRSP. AMC could, as arranged, come to the CRSP to pick up equipment for turn-in and remove the equipment from the units' property books.

4-136. The overall advantage of the CRSP was that theater trucks moved in and out of the AO quickly, providing faster throughput. Because the CRSP had a better understanding of the threat, battle rhythm, and missions of the FOBs, there was minimal disruption delivering cargo during combat operations. The use of CRSPs resulted in the elimination of the possibility of the BSBs not being ready to download, with the consequence of trucks being idle. The CRSP operation made the movement of supplies more efficient. Figure 4-39 depicts the possible lay down of CRSPs in an AOR over time.

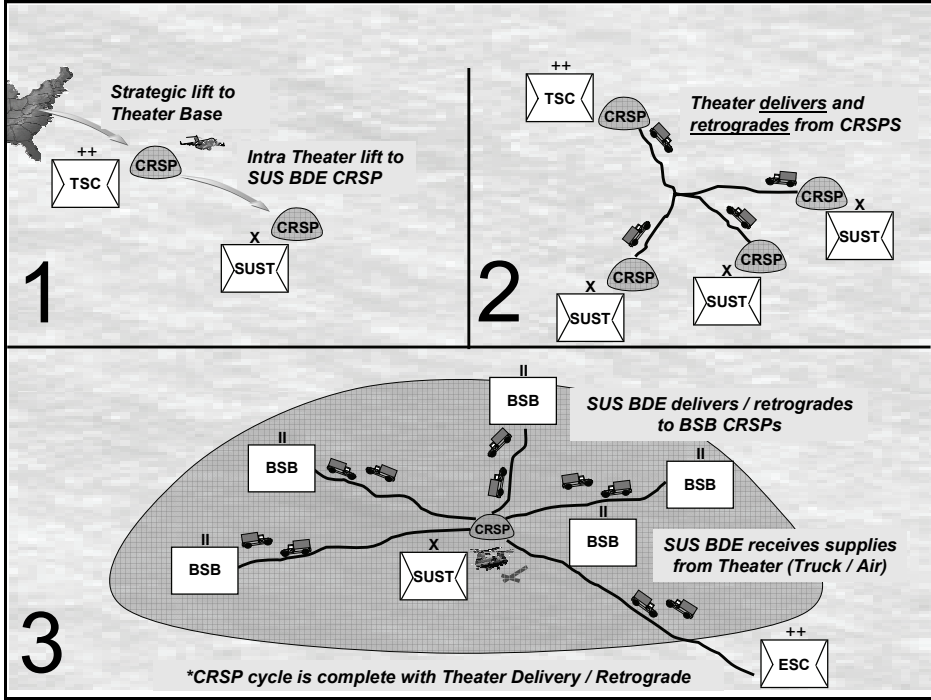

Figure 4-39. CRSP Concept of Operations

4-137. CRSPs should be used for all classes of supply except ammunition. Any mode of distribution should be accessible. Personnel should be capable of properly packing containers, loading helicopters, or building 463L pallets for fixed wing aircraft. A CRSP may be collocated with an MCT, A/DACG, or USAF Aerial Port. Figure 4-40 depicts CRSP operations in one area.

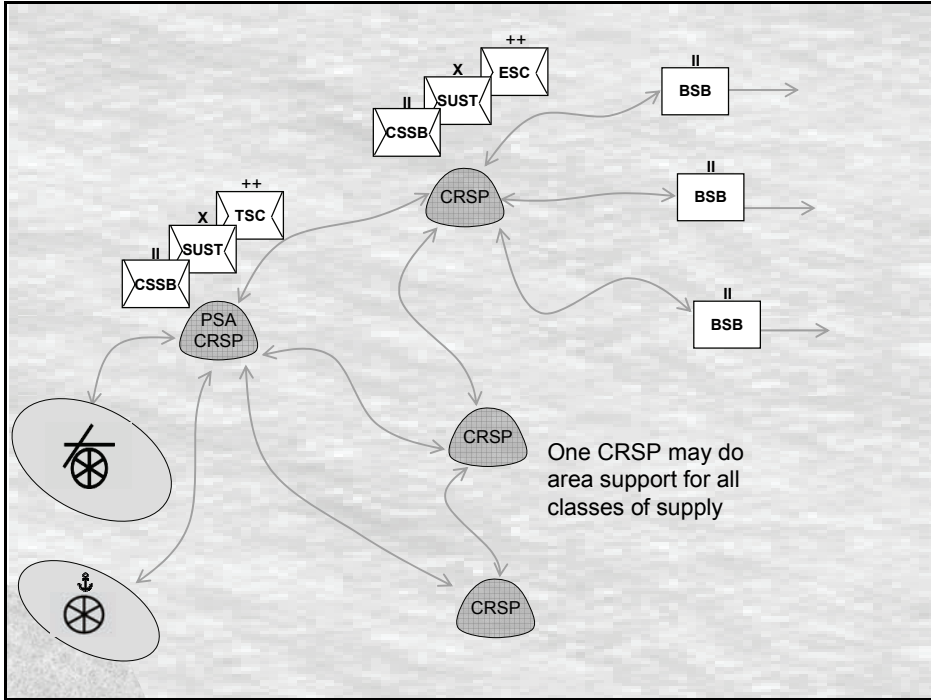

Figure 4-40. CRSP During Offensive Operations

4-138. A CRSP must have the equipment and personnel capable of running convoys, handling materiel inside the warehouse, and handling containers and 463L pallets. Personnel should have the skill to properly pack and unpack containers and to properly build 463L pallets. There are also requirements for tracking and manifesting cargo, transmitting ITV data to the DOD ITV system, and for burning and reading RF tags. There must be resident within the CRSP the capability to track by container, pallet ID, transportation control number (TCN), or transportation movement release (TMR); possibly in secure mode. A CRSP also requires secure voice and data communication capability.

### **THEATER DISTRIBUTION CENTER**

4-139. Unlike the CRSP, the theater distribution center (TDC) holds and stores supplies in addition to performing the functions of a hub. As well as tracking en route cargo, the TDC will perform many of the same receiving and issuing functions of an SSA and would cross-level excess materiel to cover shortages among the units it supports. A TDC must perform the following:

- Supply management functions found in a quartermaster support company.
- Cargo tracking and convoy movement control functions found in movement control teams.
- Cargo handling functions found in cargo transfer companies.

C2 would be provided by a sustainment brigade (TD). The TDC would require a large area for operations to include covered climate-controlled storage for cargo, open storage for containers and MILVANs, secure storage for high value cargo, and possible capability for refrigerated storage if contractor support is unavailable for food acquisition and storage. To prevent pilferage, the entire area should remain secured with controlled access. Unless the center establishes operations in a prepared location, engineering assets may be necessary to prepare the site. The distribution center (DC) should be able to handle all classes of supply except ammunition. POL storage and issuance is also a possibility. Personnel should be capable of stuffing containers, loading helicopters, or building 463L pallets for fixed wing aircraft. A TDC may be collocated with an MCT, A/DACG, or USAF Aerial Port.

4-140. The DC must be located near major road networks, airfields, and railheads to receive and distribute supplies through a variety of means. The platoon would require a variety of equipment to perform its mission, especially materials handling equipment (MHE) to include all terrain capable, organic bulk transport equipment, long haul transportation assets, light sets, generators, computers, RF interrogators, and radios. A TDC must have the equipment and personnel capable of organizing convoys, handling materiel inside the warehouse, and handling containers and 463L pallets. Personnel should have the skill to stuff and unstuff containers and to properly build 463L pallets. TDCs would provide for receipt, storage, issue, and distribution of supplies. It would configure LOGPAC loads for forward distribution and supports line haul and local haul motor transport operations. A TDC serves as a functional base for subsistence distribution. The maintenance activity provides emergency refueling and repair of vehicles transiting the DC as well as complete support of owned equipment. The TDC provides ITV of cargo being throughput and stored, to include burning and reading RF tags and transmitting ITV data to the DOD ITV system. It also performs the cargo documentation function. There must be resident within the DC the capability to track by container, pallet ID, TCN, or TMR; possibly in secure mode. A DC also requires secure voice and data communication capability.

### **CONVOY SUPPORT CENTERS (CSC)**

4-141. CSC provide mess, maintenance, crew rest facilities, and other personnel and equipment in support of convoys moving along Main Supply Routes/Alternate Supply Routes (MSR/ASR). CSC's can also serve as Life Support Areas and, in some instances, a site for supply point distribution. They are a cross between a trailer/cargo transfer point and an intermediate truck terminal with the mission to support, enhance, and otherwise facilitate direct haul convoy operations. CSCs are located along the MSR/ASR, generally every 200 miles or as required by METT-TC. When practical, they will be collocated with existing organizations such as the TDC/hub, an intermodal terminal, or a Central Receiving and Shipping Point (CRSP). When operating as a stand alone facility, they may require additional capability for protection above Level 1. Services provided by all CSCs are refueling, quick-fix maintenance, and asset recovery. They are established at the discretion of the Combatant Commander, and are normally operated

by a CSSB. CSC's must have the appropriate equipment to read RF tags and to enable ITV of units and supplies moving within the theater distribution system. CSC's must also have the appropriate equipment to support internal CSC operations and to support external, secure, and non-secure communication with the C2 HQ and with en route convoys. This would require, as a minimum, a Command Post Node. The level of support provided is mission dependent.

4-142. CSCs may be formed from any combination of logistics units, usually consisting of a battalion headquarters to provide C2 and other company/platoon-sized logistics units, as necessary, to provide the desired level of support. Three levels of CSC support are described below.

### Truck Stop

4-143. A truck stop CSC (see Figure 4-41) is a full service CSC that operates as part of a larger support area, supporting convoys moving through the area en route to another hub or final destination. The sustainment brigade designates a CSSB to provide C2 of a CSC providing full support. Support units required to man the truck stop type of CSC are: POL support platoon (50K) with bag farm, MCT, maintenance contact team, medical treatment team, and an infantry platoon for security (METT-TC). The truck stop CSC is capable of providing bulk and retail Class III, bulk and bottled water, Class I (MKT-UGR/MRE), Class IX (ASL and prescribed load list), Class V for protection, and replenishing combat lifesaver (CLS) bags. The truck stop medical treatment team is authorized to carry limited CLS bag resupply stocks to support contingency resupply operations for convoys. Limited stocks consist of common high use CLS restock items minus controlled substances (narcotics). A truck stop CSC provides life support for all convoy personnel and might include one or more 150-person modules of the Force Provider set (tents and cots), a shower, laundry, and clothing repair (SLCR) team from a field services company and Army and Air Force Exchange Service support.

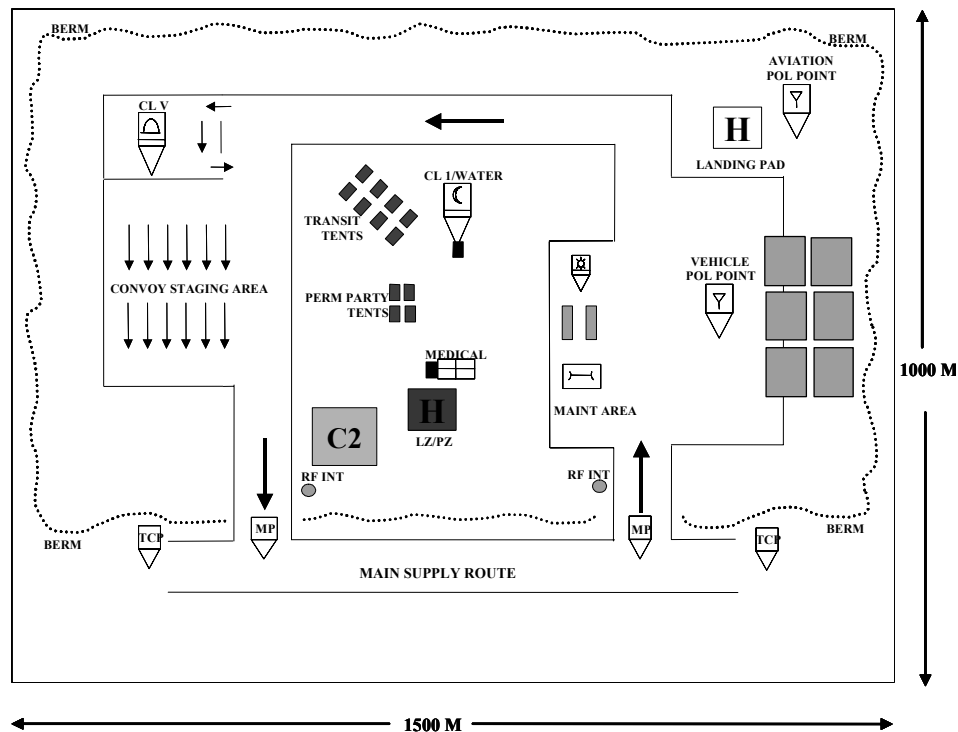
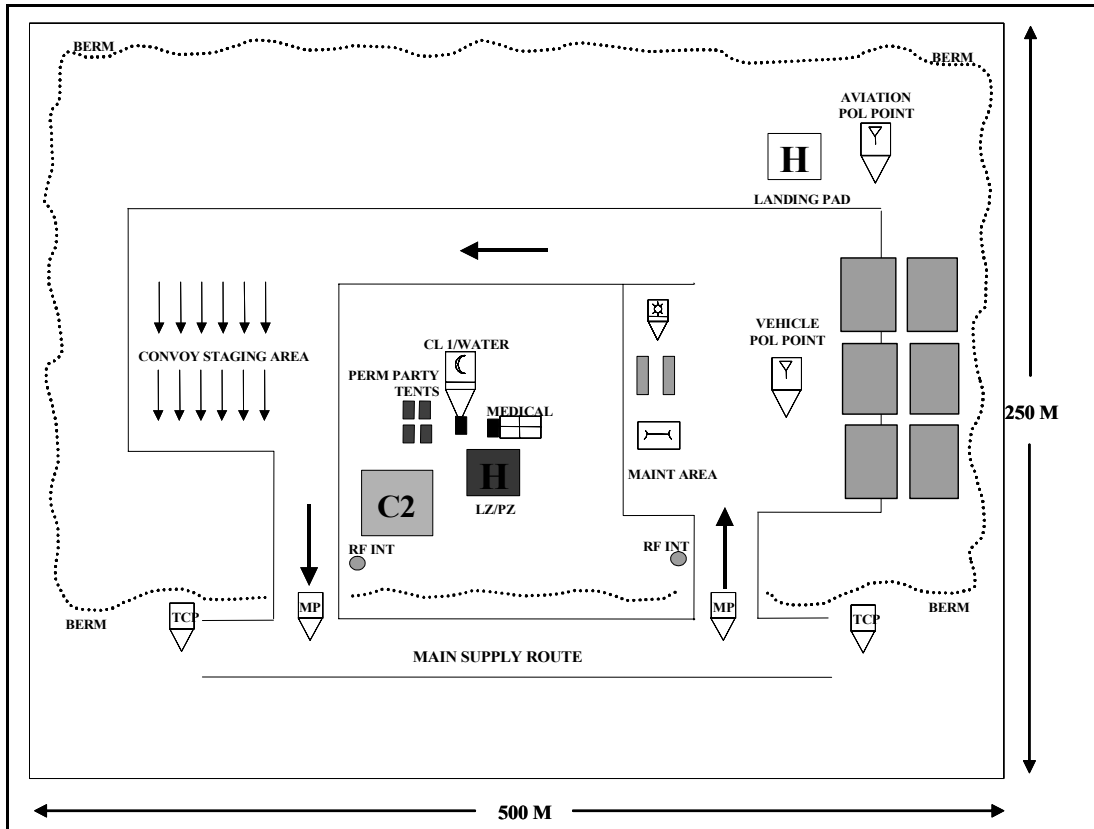

Figure 4-41. Truck Stop Convoy Support Center

**Mini-Mart**

4-144. Mini-Mart CSC (see Figure 4-42) is a medium service CSC that operates as part of a smaller support area supporting convoys moving through the area en route to another hub or final destination. The CSSB provides C2 for the Mini-Mart CSC. Support units required to man the truck stop type of CSC are: POL support platoon (50K) with bag farm, MCT, maintenance contact team, medical treatment team, and an infantry platoon for security (METT-TC). The Mini-Mart CSC is capable of providing bulk and retail Class III, bulk and bottled water, Class I (MKT-UGR/MRE), and replenishing combat lifesaver (CLS) bags using procedures prescribed in paragraph 4-165 above. LOG automation is supported by ULLS/SAMMS and DAMMS-R. There is no life support capability except for CSC personnel.



**Figure 4-42. Mini-Mart Convoy Support Center**



## Pit Stop

4-145. Pit stop CSC (see Figure 4-43) provides minimal service. It is normally limited to Class III and Class I (MRE/water) and possibly minimal maintenance support. The CSSB provides C2 for the Pit Stop CSC. Support units required to man the truck stop type of CSC are: POL support platoon (truck to truck), MCT, maintenance contact team, CLS capability, and an infantry squad for security (METT-TC). The truck stop CSC is capable of providing bulk and retail Class III, bulk and bottled water, and Class I (MKT-UGR/MRE). There is no LOG automation. There is no life support capability except for CSC personnel.

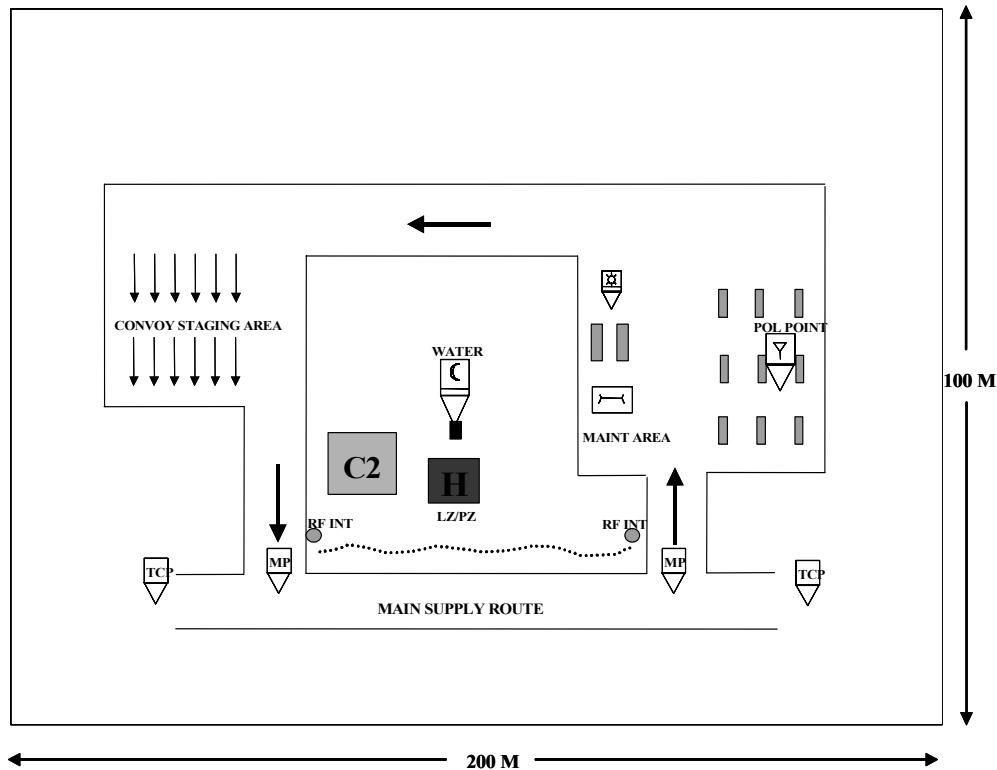

Figure 4-43. Pit Stop Convoy Support Center

## SECTION IV – PERSONNEL SERVICES SUBFUNCTION

### HUMAN RESOURCES SUPPORT

4-146. The objective of HR support is to maximize operational effectiveness and to facilitate enhanced support to the total force (Soldiers, DOD civilians, Joint service personnel, and others that deploy with the force). Reliable, responsive, and timely HR support in the operational area is critical to supporting the operational commander and the force. It relies on secure, non-secure, robust, and survivable communications and digital information systems. These provide a common operational picture, asset visibility, predictive modeling, and exception reporting—important to making accurate and timely manning decisions. HR support as described in FM 1-0, Human Resources Support, consists of 10 core functions and capabilities. These include—

- Personnel readiness management (PRM).
- Personnel accountability and strength reporting (PASR).
- Personnel information management (PIM).

- Reception, replacement, redeployment, rest and recuperation, and return-to-duty (R5).
- Casualty operations.
- Essential personnel services (EPS).
- Postal operations.
- MWR.
- Band operations.
- HR planning and operations.

HR reporting is discussed further discussed in Appendix D.

4-147. At the unit level, the focus of HR support encompasses all core functions listed in paragraph 4-168 and are conducted by brigade and battalion S-1 sections for assigned or attached personnel (see FMI 1-0.01, S-1 Operations for additional information). HR units attached to the sustainment brigade provide HR support on an area basis.

4-148. The commander of sustainment organizations is responsible for the training, readiness oversight, and mission execution of assigned/attached HR organization. FMI 1-0.02, Theater Level HR Operations, provide additional detail on these area support functions. The commander has an overall responsibility for:

- Postal. The commander has the overarching mission to ensure adequate postal forces and activities are in place to ensure the timely delivery of mail to/from Soldiers in the brigade footprint and for ensuring compliance with USPS directives. The commander must also ensure postal force is trained and mission capable and that adequate facilities are established and sustained.
- Casualty. The commander has a critical role to ensure casualty elements (platoons and teams) are resourced and distributed in compliance with theater policy that ensures timely and accurate reporting. The commander must be prepared to provide or coordinate augmentation in the event of mass casualty. Through the assigned HR Company, the commander ensures casualty personnel are trained and capable to execute this mission.
- R5. The commander has the responsibility to ensure R5 operations are resourced and adequate to account for all personnel entering or exiting at all APOD/E and SPOD/E when an R5 Team is assigned. The critical HR task accomplished in R5 operations is personnel accountability which updates the theater database (DTAS). The commander ensures all life support, transportation, and coordination requirements are provided in a timely manner to minimize any delays, particularly for personnel joining their units.

4-149. The HR Branch within the SPO is the commander's hub for HR integration, synchronization, planning, coordination, sustainment, and operations. This is a valuable asset that provides the commander a well trained and capable staff to plan and coordinate sufficient HR organizations needed to provide HR support based on the commander's intent. It is critical that the HR Branch is included in the planning process of the staff (SPO). The HR Branch provides technical guidance and resources to the SRC12 organizations (supporting units) ensuring they have the capability to provide the required postal, R5, and casualty support directed in the HR concept of support. Guided by supported/supporting relationships, the G-1/S-1s request support and resources for postal and R5 operations through the HR Branch. The HR Branch processes the request, prioritizes the request based on the available HR resources and scope of requested support to determine supportability. If the HR Branch is unable to support the request with HR assets internal to its sustainment brigade, the HR Branch forwards the request to the ESC/TSC's SPO for resolution.

## **HUMAN RESOURCES COMPANY**

4-150. The HR company provides theater-directed HR support for the postal, R5, and casualty core competencies. The company is tailorable and scalable, allowing Sustainment commanders to tailor the support to meet the requirements of the supported population. The HR Company has specific capabilities and associated tasks and is not intended to augment S-1 sections for the delivery of HR support outside the postal, R5, and casualty core competencies.

4-151. The MMT team provides tailorable HR support to the theater of operations by establishing, coordinating, and executing military mail terminal operations under the control of the sustainment brigade with the augmentation of an HR company. The MMT mission is a specific task required to ensure the overall effectiveness of the theater postal system.

4-152. The TG R5 team provides tailorable HR support to establish the TG R5 center at the inter-theater APOD to establish and maintain the personnel accountability of entering, departing, and transiting personnel and to coordinate the execution of sustainment tasks within the Sustainment brigade and joint elements operating in and around the APOD. The TG R5 center mission is a critical element of the early theater opening sustainment mission and has an enduring requirement during theater distribution operations, as it ensures the establishment and maintenance of an accurate theater deployed accountability system required by Congress.

## FINANCIAL MANAGEMENT OPERATIONS

4-153. The finance operations mission is to sustain Army, joint, and multinational operations by providing timely commercial vendor and contractual payments, providing various pay and disbursing services, maintaining battle flexibility for combat units to engage enemy forces and following policies and guidelines established by the National FM providers. Financial management units provide support during all operational phases. The level of support varies according to the nature of the operation and depending on METT-TC factors. Finance operations support must be responsive to the demands of the unit commanders at all levels, requiring FM leaders to anticipate and initiate the finance support needed. FM reporting is discussed further discussed in Appendix E.

### FINANCIAL MANAGEMENT SPO (FM SPO)

4-154. The Sustainment Brigade FM Support Operations Team (FM SPO) monitors and tracks financial management operations throughout the area of operations (AO). The team integrates all FM operations; plans the employment of FM units; coordinates FM requirements; synchronizes the FM network; and manages the FM systems. It also coordinates for additional operational and strategic FM support when needed. All functions of the FM SPO are closely coordinated with the FM CO commander and either the Division or ARFOR G-8. Some of these functions include:

- Integrate all FM operations within the AO. The FM SPO evaluates the adequacy of support throughout the AO by analyzing workload data, supporting population size, scheduling support at forward operating bases, and making recommendations to maximize the efficiency of limited FM resources. It monitors the use of cash or instruments representing cash in the operational area during full spectrum operations.
- Plan employment of FM units. The FM SPO works with the Financial Management Center (FMC), G-8, and FM COs to adapt financial management support to changes in the operational area.
- Synchronize division FM network. The FM SPO coordinates financial management efforts for the sustainment brigade across all supporting FM COs, contracting offices, and civil affairs units.
- Manage all FM systems. In coordination with the FMC, G-8, and FM CO, monitors the employment and update of financial management systems used for disbursing, military pay, travel pay, vendor pay, and resource management. Planning would include coordinating communications support for expanding electronic banking initiatives.
- Coordinate FM requirements. In coordination with the FMC, G-8, and FM CO, coordinates cash requirements for special funding sources such as Commander's Emergency Response Program, Soldier support (check cashing, casual pays, and vendor payments).
- Coordinate operational FM support. The FM SPO establishes mutually supporting flow of information among the FMC, G-8, and the FM CO, enabling responsive FM support in the operational area.

## **FM COMPANY (FM CO)**

4-155. The FM CO is assigned to either the sustainment brigade STB or a CSSB. The FM CO analyzes the supported commander's tasks and priorities to identify the financial resource requirements that will enable mission accomplishment. The FM CO performs the following functions:

- Ensures regulatory guidelines, directives, and procedures are adhered to by all operational elements of the FM CO and subordinate FM detachments.
- Establishes Disbursing Station Symbol Numbers and Limited Depository accounts.
- Provides limited US and non-US pay support.
- Funds subordinate FM detachments and determines the need for currency (US and foreign) and its replenishment.
- Maintains regulatory accountable records.
- Provides EPW, civilian internee, and Local National pay support.
- Establishes banking relationships and procedures.
- Makes payments on prepared and certified vouchers.
- Receives collections.
- Receives and controls all currencies and precious metals.
- Cashes negotiable instruments.
- Converts foreign currency.
- Protects funds from fraud, waste, and abuse.
- Establishes a management internal control process providing reasonable assurance that government assets are protected and safeguarded.
- Ensures funds and other assets are protected and revenues and expenditures are properly accounted for in accordance with congressionally mandated accounting and reporting requirements.

## **SECTION V – ARMY HEALTH SERVICE SUPPORT SUBFUNCTION**

### **ARMY HEALTH SYSTEM (AHS) SUPPORT**

4-156. AHS supports a subcomponent of the military health system capabilities to deliver HSS and FHP in support of full spectrum operation. AHS support involves the delineation of support responsibilities by capabilities (roles of care) and geographical area (area support). The AHS that executes the HSS/FHP initiatives is a single, seamless, and integrated system. It is a continuum from the point of injury or wounding through successive roles of care to the CONUS-support base. The AHS encompasses the promotion of wellness and preventive, curative, and rehabilitative medical services. It is designed to maintain a healthy and fit force and to conserve the fighting strength of deployed forces.

### **SUSTAINMENT BRIGADE**

4-157. The sustainment brigade surgeon section (see also Chapter 2) acts primarily as a medical coordination and synchronization element for the sustainment brigade. The brigade surgeon section coordinates through the division surgeon section with the medical brigade for Role 2 support for the sustainment brigade and its subordinate units. It also coordinates for COSC, preventive medicine, dental, ground ambulance, air ambulance, veterinary, and laboratory support as required. The sustainment brigade supports the medical brigade and MMB by delivering Class VIII to forward based medical units/elements and the MEDLOG officer in the brigade surgeon section coordinates the shipment of Class VIII by the sustainment brigade.

### **MEDICAL BRIGADE (MED BDE)**

4-158. The MED BDE may be OPCON to a sustainment brigade when the sustainment brigade is in a command relationship with the senior tactical headquarters. The MED BDE provides a scalable

expeditionary medical C2 capability for assigned and attached medical functional plugs task-organized for support of deployed forces. The MED BDE brings all requisite medical C2 and planning capabilities to provide responsive and effective AHS throughout the AO. Some MED BDE subordinate elements will collocate with sustainment units in LSAs and FOBs, because MTFs require essential non-medical supplies and services and the LSAs and FOBs will require AHS support since most sustainment units do not contain organic medical assets.

### **MEDICAL REPORTING**

4-159. The MC4 and Theater Medical Information Program support the information management requirements for the brigade surgeon section and BCT medical units. The brigade surgeon section uses BCS3, FBCB2, and MC4-TMIP to support mission planning, coordination of orders and subordinate tasks, and to monitor/ensure execution throughout the mission.

4-160. The MC4-TMIP is an automated system, which links health care providers and medical support providers, at all levels of care, with integrated medical information. The MC4-TMIP receives, stores, processes, transmits, and reports medical C2, medical surveillance, casualty movement/ tracking, medical treatment, medical situational awareness, and medical logistics data across all levels of care.

**This page intentionally left blank.**

## Appendix A

# LOGISTICS PREPARATION OF THE BATTLEFIELD

Logistics preparation of the battlefield (LPB) is a key conceptual tool available to personnel in building a flexible strategic/operational support plan. Logistics preparation of the theater of operations consists of the actions taken by logisticians at all echelons to optimize means (force structure, resources, and strategic lift) of supporting the joint force commander's plan. These actions include identifying and preparing ISBs and forward operating bases; selecting and improving LOC; projecting and preparing forward logistics bases; and forecasting and building operational stock assets forward and afloat. LPB focuses on identifying the resources currently available in the theater of operations for use by friendly forces and ensuring access to those resources. A detailed estimate of requirements, tempered with logistics preparation of the theater of operations, allows support personnel to advise the JTF/ASCC/ARFOR commander of the most effective method of providing responsive support.

## INTELLIGENCE IN SUPPORT OF LOGISTICS

A-1. The logistician uses intelligence to develop and execute the logistics support plan. Logistics intelligence is critical to the planning effort. Some of the areas that should be included in the intelligence analysis are listed below:

- Intent to engage in multinational operations and the extent of logistics support to be provided to non-DOD agencies and allies.
- Available resources in the AO.
- Conditions that alter consumption factors, such as severe climate changes or a requirement to provide support to allies.
- Capabilities of local facilities to support reception and staging operations.
- Foreign military logistics structure, national infrastructure capabilities, and political inclination to facilitate joint forces support.
- Environmental, geographical, climatological, and topographical factors that may affect support operations.
- Analysis of the capabilities of the host nation's and region's LOCs and capabilities to support the operation.

A-2. Intelligence is equally critical for war and stability operations. Logisticians must have a complete logistics data base or file to develop a solid plan for the LPB.

A-3. LPB is those actions (force structure, resources, and strategic lift) taken to reduce the cost of logistically supporting an OPLAN or a contingency plan. LPB minimizes or eliminates potential problems at the outbreak of hostilities, during deployment, and throughout the operations. It is a systematic tool used by logisticians and commanders to complete their mission. It becomes the basis for deciding where, when, and how to deploy limited resources (supplies, equipment, people, and money).

A-4. The ASCC of a combatant command will prepare supporting Army plans with logistics planners concentrating on the logistics plans. Once logistics planners know the contingency country or geographic region, they can begin to build a logistics information data base. This applies even if the command has a small chance of being deployed to a particular area. Once completed, the information data base file can be

used to develop a comprehensive plan for LPB. The relative priority given to this effort will depend on the concept of operations and other command priorities. The key point is that the logisticians cannot afford to wait until maneuver units deploy to begin the LPB. It is a complex and time consuming function. If planners anticipate correctly at the national and combatant command levels, troops should never have to be inserted into a completely cold base.

A-5. Any actions that can reduce the cost of moving supplies, equipment, and people into an objective or contingency area are candidates for inclusion in the LPB plan. Planning must provide for the timely arrival of sustainment assets that are balanced according to the mission. Strategic lift assets are extremely limited. Commanders cannot afford to squander even one sortie on movement of unnecessary supplies, equipment, or personnel. A well thought out LPB plan and the time required for proper execution, will allow better use of our scarce strategic lift.

## **RELEVANT LOGISTICS INFORMATION**

A-6. The following paragraphs contain types of relevant logistics information. These can be added to or taken away as individual missions dictate.

### **GEOGRAPHY**

A-7. Collect information on climate and terrain in the AO. Determine if current maps are available. Use this information to determine when various types of supplies, equipment, and field services will be needed. For example, use water information to determine the need for early deployment of well-digging assets and water production and distribution units.

### **SUPPLY**

A-8. Collect information on supply items that are readily available in the AO. Determine which of these can be used in support of US forces. Subsistence items, bulk petroleum, and barrier materials are often available in country. Collect information on the supply system of the armed forces of the supported country, determine if it is compatible with the US system. Has the host nation bought, through foreign military sales, repair parts supporting current US systems? Can contingency contracting provide resources from HNS sources or third country sources until Army capabilities arrive in the AOR? Answers to these types of questions will aid in analyzing whether HNS negotiations are possible.

### **FACILITIES**

A-9. Collect information on warehousing and cold storage facilities, production and manufacturing plants, reservoirs, administrative facilities, sanitation capabilities, and hotels. Their availability could reduce the requirement for deployment of similar capacity.

### **TRANSPORTATION**

A-10. Collect information on road nets, truck availability, rail nets, bridges, ports, cargo handlers (longshoremen), petroleum pipelines, and MHE. Also collect information on traffic flow, choke points, and control problems.

### **MAINTENANCE**

A-11. Collect information on maintenance facilities that could support US or coalition equipment. Examine the supported country's armed forces. Could they supplement our capability? Is there a commonality in equipment and repair parts? Does the country have adequate machine works for possible use in the fabrication of repair parts?



## **GENERAL SKILLS**

A-12. Collect information on the general population of the supported country. Is English commonly spoken? Are personnel available for interpreter/translator duties? Will a general labor pool be available? What skills are available that can be translated to joint forces? Will drivers, clerks, MHE operators, food service personnel, guards, mechanics, and longshoremen be available?

## **MISCELLANEOUS**

A-13. Include any other information that could prove useful. Set up other categories as needed.

## **SOURCES OF INFORMATION**

A-14. Collecting intelligence is not as difficult as it first may appear. A lot of information is routinely collected. There are several sources that can aid the logistician in building the LOGEEI data file. The below are some possible sources of information.

## **EMBASSY STAFFS**

A-15. The State Department has a worldwide network of embassies. These embassies are excellent sources of detailed information on a particular country. Embassy staffs routinely do country studies that, when current, can provide the bulk of the information you may need. A good library is another excellent source of information.

## **INTELLIGENCE PREPARATION OF THE BATTLEFIELD (IPB) RELATED DATA**

A-16. The weather and terrain data bases in the IPB, with its overlays, can provide excellent current information. This can be used in preselecting LOCs and sites for sustainment facilities. The event analysis matrix and template in the IPB (see FM 34-130) can also be used to assess the need for road, rail, airfield, port, and bridge improvements.

## **CIVIL AFFAIRS DATA**

A-17. Civil affairs (CA) units CMO can provide information and knowledge of the operational environment to US and other coalition forces as directed. CA with their unique interaction and continuous dialogue with indigenous populations, institutions, intergovernmental organizations, NGOs, and US agencies and organizations can provide valuable information in support of the sustainment brigade mission and GCC's overall plan.

**This page intentionally left blank.**

## **Appendix B**

# **PROTECTION**

Protection consists of those actions taken to prevent or mitigate hostile actions against DOD personnel (to include family members), resources, facilities, and critical information. Additionally, counter proliferation and consequence management actions associated with chemical, biological, radiological, nuclear, and high yield explosive weapons, which includes toxic industrial material and improvised explosive devices (IED) should be addressed. These actions conserve the fighting force's potential so it can be applied at the decisive time and place and incorporate the coordinated and synchronized offensive and defensive measures to enable the effective employment of the joint force while degrading opportunities for the enemy. This appendix contains aspects of protection that are relevant to the sustainment brigade. Refer to FM 3-10 for more detailed information on protection.

### **SECTION I – RESPONSIBILITIES AND RISK MANAGEMENT**

#### **RESPONSIBILITIES OF THE SUSTAINMENT BRIGADE**

B-1. The sustainment brigade is designed to plan and conduct base and base cluster self-defense. It has the capability to defend against level I threats, assist in destruction of level II threats, and escape or evade against level III threats. When faced with a threat beyond its capabilities, the sustainment brigade relies on resources within supported maneuver units to assist in defeating the threat. Conducting an active defense against any level of threat will degrade the sustainment brigade's capability to conduct its primary mission to a greater or lesser degree dependent upon the level of the threat. All duties and functions in this appendix which are required of a sustainment brigade might also be required of a CSSB, especially base commander and base defenses functions.

#### **RISK MANAGEMENT**

B-2. This section will briefly address risk management. Commanders and staff officers whose responsibilities include risk management should refer to FM 5-19.

B-3. Risk management is a process that assists decision makers in reducing or offsetting risk by systematically identifying, assessing, and controlling risk arising from operational factors and making decisions that weigh risks against mission benefits. Risk is an expression of a possible loss or negative mission impact stated in terms of probability and severity. The risk management process provides leaders and individuals a method to assist in identifying the optimum course of action. Risk management must be fully integrated into planning, preparation, and execution. Commanders are responsible for the application of risk management in all military operations. Risk management facilitates the mitigation of the risks of threats to the force. For the purposes of this process, threat is defined as a source of danger—any opposing force, condition, source, or circumstance with the potential to negatively impact mission accomplishment and/or degrade mission capability.

B-4. Military operations are inherently complex, dynamic, and dangerous, and by nature, involve the acceptance of risk. Because risk is often related to gain, leaders weigh risk against the benefits to be gained from an operation. The commander's judgment balances the requirement for mission success with the inherent risks of military operations. Leaders have always practiced risk management in military decision

making. However, the approach to risk management and the degree of success vary widely depending on the leader's level of training and experience.

B-5. Since our involvement in the Korean conflict, US forces have suffered more losses from noncombatant causes than from enemy action. Key factors contributing to those losses include:

- Rapidly changing operational environment.
- High operational pace.
- Equipment failure, support failure, and effects of the physical environment.
- Human factors.

B-6. The fundamental goal of risk management is to enhance operational capabilities and mission accomplishment with minimal acceptable loss. The basic principles that provide a framework for implementing the risk management process include:

- **Accept no unnecessary risk:** An unnecessary risk is any risk that, if taken, will not contribute meaningfully to mission accomplishment or will needlessly endanger lives or resources. No one intentionally accepts unnecessary risks. The most logical choices for accomplishing a mission are those that meet all mission requirements while exposing personnel and resources to the lowest acceptable risk. All military operations and off-duty activities involve some risk. The risk management process identifies threats that might otherwise go unidentified and provides tools to reduce risk. The corollary to this axiom is “accept necessary risk” required to successfully complete the mission.
- **Make risk decisions at the appropriate level:** Anyone can make a risk decision. However, the appropriate level for risk decisions is the one that can make decisions to eliminate or minimize the threat, implement controls to reduce the risk, or accept the risk. Commanders at all levels must ensure that subordinates know how much risk they can accept and when to elevate the decision to a higher level. Ensuring that risk decisions are made at the appropriate level will establish clear accountability. The risk management process must include those accountable for the mission. After the commander, leader, or individual responsible for executing the mission or task determines that controls available to them will not reduce risk to an acceptable level, they must elevate decisions to the next level in the chain of command.
- **Accept risk when benefits outweigh the cost:** The process of weighing risks against benefits helps to maximize mission success. Balancing costs and benefits is a subjective process and must remain a leader's decision.
- **Anticipate and manage risk by planning:** Integrate risk management into planning at all levels. Commanders must dedicate time and resources to apply risk management effectively in the planning process and where risks can be more readily assessed and managed. Integrating risk management into planning, as early as possible, provides leaders the greatest opportunity to make well-informed decisions and implement effective risk controls. During the execution phase of operations, the risk management process must be applied to address previously unidentified risks while continuing to evaluate the effectiveness of existing risk control measures and modify them as required.

B-7. Proper application of the risk management process will assist leaders in maintaining the health and safety of their personnel and the mission capable rates for their equipment.

## SECTION II – THE THREAT

B-8. Hostile action against US forces may occur at any time, any place, and under any conditions. Recognizable, armed combatants or persons who are or appear to be civilians may commit hostile actions. Sustainment personnel must exercise vigilance against such attacks because the enemy seeks soft targets and assumes that these can be found in the areas and facilities that sustain US forces. Therefore, sustainment personnel should approach their tasks with the same warrior spirit that their combined arms counterparts exercise in their duties. This is especially true on the evolving battlefield with increased lethality, larger AOs, and more noncontiguous operations. Either the commander has to use more assets to secure sustainment activities or accept greater risk and reduced levels of sustainment activities when

sustainment personnel substitute protection measures for sustainment operations. In any case, sustainment personnel understand, train for, and plan security operations within the context of their support activities.

B-9. Sustainment elements are prime targets for the asymmetrical threat forces on the noncontiguous operational area. Terrorists, saboteurs, opposition special operations forces, and others all pose a threat to sustainment personnel, installations, and convoys. By effectively cutting LOCs between sustainment and maneuver elements or by damaging and disrupting C2, C2 information systems, sustainment automation, and/or facilities these opposing forces hope to have significant negative impact on US maneuver forces with minimum risk to their own. The sustainment brigade and its subordinate organizations must plan for and be able to defend against these threats while conducting the primary mission.

## COMBAT ACTION

B-10. The combat threat in the sustainment brigade AO may include individual acts of sabotage; inserting large, organized forces; snipers, and artillery, mortar, air, and missile attacks. Large-scale enemy attacks may require committing US reserve forces, combat units from forward areas, HN resources, or multinational resources. US forces are trained to cope with threat forces when and where they attempt to disrupt support operations. They use active and passive measures to defend against detection from the air and attack from the air, ground, and sea.

B-11. An understanding of the threat to the sustainment brigade and detailed IPB and LPB products help to protect the support structure. Threat forces conduct operations in the sustainment brigade areas and bases to seize and maintain the initiative, facilitate strategic and operational level penetrations, and degrade or destroy forces' ability to conduct support operations.

B-12. To achieve these aims, enemy activities target:

- Command and control nodes.
- Air defense artillery sites.
- Critical support facilities and units such as:
  - Ammunition and weapon storage sites and delivery systems.
  - SPODs.
  - APODs.
  - POL terminals and facilities.
  - Maintenance, supply, and services activities.
- Regeneration sites.
- Key choke points along LOCs.

B-13. Base commanders form base defense forces that provide internal base security and reinforce the base perimeter when threatened. The base defense force operates under guidance of the S-3. The sustainment brigade's base cluster operations center (BCOC) must establish a communications protocol that keeps all the bases and units informed of enemy activity and that allows reporting of enemy activity throughout the base cluster.

B-14. Defense planning includes these levels of threats:

- Level I—Threats that base or base cluster self-defense measures can defeat.
- Level II—Threats that initial response forces, but not base or base cluster self-defense measures, can defeat. Bases and base clusters can delay level II threats until response forces arrive.
- Level III—Threats targeting several friendly elements as part of a larger, coordinated effort, rather than individual, separate entities. They require a tactical combat force (TCF) to defeat them.

## **SECTION III – CHEMICAL, BIOLOGICAL, RADIOLOGICAL, AND NUCLEAR (CBRN) ENVIRONMENT**

### **CBRN DEFENSE**

B-15. The ability to sustain combat operations with an appropriate level of support is vital to operational success. Operations in CBRN environments place significant burdens on the sustainment system. Sustainment operations and facilities are at particular risk to CBRN attack to the degree that they rely on fixed sites (ports, airfields, and so on) or must remain in particular locations for extended periods of time. The need to operate in CBRN environments will add to the physical and psychological demands of military operations, with degrading effects on the performance of individuals and units. The sustainment brigade S-3 is responsible for CBRN planning.

### **PROTECTIVE EQUIPMENT**

B-16. Sufficient equipment must be available to protect not only the uniformed force but also the essential supporting US and civilian work forces. This is of particular concern for sustainment operations where potentially significant numbers of contract and HN personnel support operations. Individual and unit training for proper sizing, use of, and care for this individual and crew-served equipment is required to take full advantage of its capabilities.

### **CBRN DEFENSE PRINCIPLES**

B-17. Three principles that specifically address the hazards created by CBRN weapons include: avoidance of CBRN hazards, particularly contamination; protection of individuals and units from unavoidable CBRN hazards; and decontamination in order to restore operational capability.

### **AVOIDANCE**

B-18. Successful contamination avoidance prevents disruption to operations and organizations by eliminating unnecessary time in cumbersome protective postures and minimizing decontamination requirements. Avoiding contamination requires the ability to recognize the presence or absence of CBRN hazards in the air, on water, land, personnel, equipment, and facilities. Surveillance and detection capabilities enable units to recognize CBRN hazards. The fusion of these capabilities with information from other sources yields an overall surveillance picture supporting decisions for specific avoidance, protection, and decontamination actions. These surveillance and detection results also establish requirements for other avoidance measures such as sounding alarms, marking hazards, and warning forces. Leaders at all levels must implement measures designed to avoid or limit exposure consistent with mission requirements. These measures should include increased use of shelters during CBRN employment windows and providing key information for movement before, during, and after CBRN attacks. In planning for contamination avoidance, leaders must include an assessment of the capabilities of available detection systems. Particular challenges include the unanticipated use of biological agents and the capabilities and limitations of current remote and stand-off detection systems.

### **PROTECTION**

B-19. CBRN protection requires the planning, preparation, training, and execution of physical defenses to negate the effects of CBRN weapons and hazards to personnel and materiel. As staffs analyze their mission requirements and conditions, the planning process will yield specific actions required before, during, and after CBRN attacks. As commanders anticipate and identify CBRN risks, these actions should be clearly communicated and rehearsed from command to individual levels. CBRN protection conserves the force by providing individual and collective protection postures and capabilities.

B-20. Commanders adopt a mission oriented protective posture (MOPP) to establish flexible force readiness levels for individual CBRN protection. MOPP analysis (the process of determining a recommended MOPP) integrates CBRN protection requirements (derived from CBRN threat assessments) with mission requirements in light of the performance degradation caused by wearing protective equipment. MOPP analysis relies on accurate IPB and CBRN hazard prediction as well as a clear understanding of the force's ability to quickly increase its CBRN protection. To facilitate adapting to varying mission demands across a combatant command's AO, MOPP decisions should be delegated to the lowest level possible and retained at higher levels only in exceptional cases. The JFC has overall responsibility for providing guidance for levels of protection and ensuring timely warning of CBRN risks. Force components may require variations of configurations, such as "mask only" for identified situations, but should standardize configurations where possible. Tactics techniques and procedures (TTPs) that address specific techniques and procedures for MOPP analysis and donning protective equipment can be found in FM 3-11.4, the Multi-service Tactics, Techniques and Procedures (MTTP) for chemical, biological, radiological, and nuclear (CBRN) protection.

B-21. Sustaining operations in CBRN environments may require collective protection equipment, which provides a toxic free area (TFA) for conducting operations and performing life support functions such as rest, relief, and medical treatment. Contamination transfer into the TFA compromises the health and safety of all occupants and jeopardizes their ability to support the mission. Therefore, training must include procedures for TFA entry and exit. When collective protection is not available and mission requirements permit, plans must be developed, exercised, and evaluated to move personnel to alternative TFAs that are well away from the contaminated areas. If evacuation is not possible, building occupants may be able to gain limited protection by closing all windows and doors, turning off ventilation systems, and moving to closed, inner rooms. If there is some advance warning, occupants may be able to increase protection by sealing windows, doors, and openings, while recognizing that the building or space may quickly become uninhabitable without cooling or ventilation.

## DECONTAMINATION

B-22. Decontamination supports the post-attack restoration of forces and operations to a near-normal capability. Decontamination is intended to minimize the time required to return personnel and mission-essential equipment to a mission capable state. Because decontamination may be labor intensive and assets are limited, commanders must prioritize requirements and decontaminate only what is necessary. Commanders may choose to defer decontamination of some items and, depending on agent type and weather conditions, opt to either defer use of equipment or allow natural weathering effects (temperature, wind, and sunlight) to reduce hazards. Decontamination is organized into three categories that reflect operational urgency: immediate, operational, and thorough. Decontamination also entails special considerations for patients, sensitive equipment, aircraft, fixed sites, and the retrograde of equipment. The extent and time required for decontamination depends on the situation, mission, degree of contamination, and decontamination assets available. TTPs provide details for the technical aspects of decontamination and can be found in FM 4-11.5, MTTP for CBRN Decontamination.

B-23. Retrograde cargo may require extensive decontamination measures; specialized, highly sensitive monitoring equipment; extended weathering; or destruction. Retrograde of previously contaminated equipment may be delayed until after conflict termination.

B-24. Fixed site decontamination techniques focus on fixed facilities and mission support areas such as C2 information systems, supply depots, aerial and seaports, medical facilities, and maintenance sites.

## Sustainment Operational Considerations

B-25. Sustainment elements will operate throughout the theater of operations. Sustainment elements directly supporting engaged forces will be small, mobile units. Sustainment elements providing area support may involve larger, more complex transportation, maintenance and supply activities conducted at fixed or semi-fixed sites.

B-26. Mobile units seek to avoid CBRN contamination to the maximum extent possible. If contaminated, units identify clean areas, and on order, move along designated routes from contaminated areas. Units decontaminate equipment and conduct MOPP gear exchange during the move to clean sites.

B-27. Sustainment units at the operational level, in contrast, may be required in emergency situations to conduct operations from contaminated fixed sites until they can relocate to clean areas.

B-28. In most circumstances, the sustainment infrastructure in a theater of operations operates with a substantial complement of nonmilitary personnel. In a typical theater, sustained operations will rely heavily on military personnel, DOD civilians, HNS personnel, other nation support personnel, and contractor provided sustainment support personnel. During the early phases of deployment, the sustainment infrastructure may rely on HNS personnel for port operations and transportation requirements. Protection of all types of personnel in the AO is required and must be included in the CBRN planning and preparation.

## **WARNING SYSTEMS**

B-29. In order for individuals and units to take necessary self-protection measures, timely warning of CBRN attacks and subsequent spread of contamination is essential. The JFC has the responsibility, in coordination with the HN, to establish an effective and timely warning system, and to exercise this system on a recurring basis. Sustainment commanders tied to a fixed site should monitor CBRN warning systems continuously and should be capable of passing warnings to workers and units throughout their sites. Because of the variety of delivery methods for CBRN weapons and the limitations of detection capabilities, personnel and units may not receive warning before exposure occurs. Warning systems should be designed to alert workers promptly upon initial detection of an attack. Since workers may be widely dispersed throughout the area, a site-wide alarm system, capable of being activated immediately upon receipt of warning, must be available, maintained, and exercised regularly.

B-30. At many sites, military throughput will rely on civilian labor. Sustainment planners must consider the vulnerability of HN and other civilian workers to attack and plan accordingly. Commanders are responsible for ensuring mission-essential civilian workers receive appropriate equipment and training and are integrated into area CBRN defense plans.

## **MATERIALS HANDLING EQUIPMENT (MHE)**

B-31. Typically, even during high capacity operations, much of the MHE at a facility is not in use. Commanders should protect idle MHE from exposure to chemical or biological agents in the event of attack. Housing and covering MHE with plastic, or otherwise protecting it from exposure, can ensure that it will be readily available to resume operations after the attack.

## **AERIAL PORTS**

B-32. Regardless of an aerial port's CBRN preparedness, some aircraft will not be able to land at or depart from contaminated airfields. Of particular importance are limitations in CBRN environments on the employment of the civil reserve air fleet, civilian, and other aircraft under contract to support military operations. Sustainment plans must provide for replacing these aircraft with other airlift assets or conducting trans-load operations from bases outside the immediate threat area. These replacement aircraft would have to operate from trans-load airbases to shuttle the affected cargo and passengers to the theater of operations. If that is not feasible, alternate means (sea, rail, wheeled transport, and so on) must be made available to accomplish the mission.

## **SEA PORTS**

B-33. In large-scale operations, US equipment and materiel normally enter the theater of operations on strategic sealift ships and off-load at SPOD. The vital importance of these seaports to US power projection capability makes them an attractive target for CBRN attack. However, conducting successful attacks against SPODs presents significant challenges to the adversary. If port managers and operators are properly



prepared to survive the attack and sustain operations, CBRN attacks may not cause significant long-term degradation of throughput capacity. This is especially true at large ports where many piers, storage areas, and much of the MHE may escape contamination. Operations in these cases may be limited more by the effects of the attacks on the local workforce and nearby civilian population.

B-34. Each SPOD provides unique capabilities and has different vulnerabilities in CBRN environments, but contamination avoidance is an essential element of sustaining throughput operations. In normal circumstances, a port is but one node of a complex, theater-wide sustainment network. When possible, plans should include options for redirecting incoming ships from contaminated ports to those that are uncontaminated. However, when alternate ports with adequate capacity and berths to handle large cargo ships are not available, it may be necessary to continue operations at contaminated ports. In considering alternate ports, sustainment planners must take into account the requirements for unit equipment to arrive in proximity to the marshalling areas for unit personnel, ammunition, and sustainment supplies in order to ensure a coherent RSO for affected units.

B-35. In some cases, it will be possible to continue operations at a contaminated port. While CBRN attacks may result in contamination of some operating surfaces, the size of the contaminated area may be small compared to the size of the port. The capability to shift operations to those areas and facilities within the port that escaped contamination is key to sustaining throughput operations. Proper preparation can significantly reduce the impact of CBRN attacks on a SPOD.

## **RECEPTION STAGING AND ONWARD MOVEMENT (RSO)**

B-36. The permanency of sites for RSO of arriving forces can vary widely between theaters of operations. Theaters of operations with large forward-deployed forces rely on fixed sites for a wide variety of activities, such as pre-positioned stock maintenance and control, supply and maintenance, materiel and transportation management, and sustainment network operations. Theaters of operations with limited forward presence normally rely more heavily on temporarily fixed sites (facilities that are transportable or mobile but, due to ongoing operational constraints, may not be rapidly moved).

B-37. Commanders will ensure that adequate detection, personnel protection, and decontamination assets are available to meet the threat. They will identify alternate sites and prepare and rehearse activation plans.

B-38. Consideration of RSO in CBRN environments encompasses a number of specific functional areas.

B-39. Staging areas for personnel or equipment near APODs and SPODs may be attractive targets for CBRN attack. Sustainment planners must assess the relative value of the convenience provided by establishing large centralized facilities, which are more easily targeted, and the enhanced security that results from having more smaller dispersed facilities that are more difficult to C2 but less vulnerable to CBRN attack. While the anticipated threat will influence the staging area selection process, adequate facility and area space availability may be the determining considerations. Planning must consider equipment marshalling areas and rail yards (which may not be in close proximity of APOD and SPOD facility complexes); sustainment hubs and bases (which may be fixed facilities with large forward-deployed forces); and force integration assembly areas (where deploying units complete deployment recovery, equipment receipt, and processing and preparation for movement to TAAs).

## **MAIN SUPPLY ROUTES (MSRs)**

B-40. The vulnerability of MSRs to CBRN attack may vary widely among theaters of operations. In those that rely on a few major MSRs and have limited alternative routes and off-road capability, CBRN attacks may have a greater impact on operations than in those with more extensive supply routes and where obstacles can more easily be traversed.

## CONTRACTOR AND HNS CONSIDERATIONS

B-41. The three basic categories of external support for US military operations are wartime HNS, contingency contracts, and current contract agreements. These usually exist in conjunction with one another and collectively provide a full sustainment capability to the theater of operations. Contracts or agreements will clearly specify services to be provided during periods of crisis or war. Sustainment commanders should not expect unprotected or untrained individuals to continue to provide essential services under the threat of CBRN attack or during operations in CBRN environments. Massive worker absenteeism is possible and a lack of adequate protective clothing and equipment could result in significant casualties should an attack occur. The commander is responsible for ensuring that mission-essential personnel receive appropriate equipment and training.

B-42. CBRN protection includes individual and collective survival skills as well as operational training. Survival skills refer to the capability to take required, immediate action upon CBRN attack, to include masking, proper wear and care of protective clothing and equipment, personal decontamination, and buddy aid. Operational training refers to the ability to continue to perform essential functions under MOPP conditions and resume normal operations after an attack. Essential functions and tasks include convoy driving, supply and equipment loading, refueling operations, and materiel decontamination.

## SECTION IV – FIRE SUPPORT

### FIRE SUPPORT CONSIDERATIONS

B-43. The sustainment brigade, and all subordinate commanders and staffs, must have a thorough understanding of fire support procedures, organizations, and assets that are available within their AO. Normally, the ESC will have a dedicated fires battalion assigned for fire support that a sustainment brigade may call upon. However, this unit might not be available until the theater of operations is mature.

B-44. The sustainment brigade S-3 must include fire support considerations into their planning and the fire support information must be disseminated to all subordinate elements. All fire support assets need to be assessed (artillery, mortar, UAS, CAS, and naval) to determine availability and coordination requirements. Planning should focus on close coordination with the fires units and detailed procedures to request fires support. It should be routine for all personnel to receive training on call for fire procedures and to rehearse the procedures. The sustainment brigade S-3 should be prepared to provide the fires unit recommended targets and target indicators within the sustainment brigade AO.

## SECTION V – PROTECTIVE MEASURES

### PROTECTIVE MEASURES

B-45. Sustainment brigade units take several measures to reduce their vulnerability to enemy operations. These measures include dispersion, cover, concealment, camouflage, intelligence gathering, obstacles, and air and missile defense.

#### DISPERSION

B-46. Sustainment brigade organizations disperse as much as possible throughout the assigned AO. Dispersion as a protective measure is balanced against the potential deficits to support operations and the base cluster defense system. Dispersion helps avoid catastrophic damage from air and mass destruction weapons. Even if a sustainment brigade unit is not the primary target, it may be attacked as a target of opportunity. The dispersion required depends on the following:

- **Type of threat.** The probability of attack by air, for example, requires greater dispersion than an attack by small ground forces.
- **Terrain.** Road networks with good access that can bear expected traffic loads allow for greater dispersion of elements. Occupying urban terrain decreases dispersion requirements because of the cover provided by buildings in built-up areas.
- **Defensibility.** Dispersion also depends on the ability of a unit to prevent, resist, or defeat enemy forces. Built-up areas may offer more defensible facilities requiring less improvement than field locations. However, built-up areas may risk loss of mobility if withdrawal is necessary. In the field, defensibility improves as dispersed units consolidate to form closely knit base clusters.

## ENGINEER SUPPORT

B-47. Engineer survivability support will be important for the elements of the sustainment brigade. When available, it may be used for a variety of protection hardening measures in support of the sustainment brigade to include survivability (see FM 5-103, Survivability Operations) support and support to camouflage, concealment, and decoys. Engineers may also provide geospatial support to the sustainment brigade's protection efforts. See FM 3-34 for a discussion of further potential engineer support.

## COVER, CONCEALMENT, AND CAMOUFLAGE

B-48. The enemy cannot target sustainment brigade resources that it cannot detect. Cover, concealment, and camouflage remain critical to protecting sustainment units, facilities, and supplies from enemy detection and attack.

B-49. Cover includes natural and artificial protection from enemy observation and fire. When selecting sites, advance parties consider the type of cover available. See FM 20-3, Camouflage, Concealment, and Decoys, for more information.

B-50. Concealment includes natural or artificial protection from enemy detection. Sustainment brigade units use concealed ingress and egress points and halt locations within support locations.

B-51. Camouflage consists of using natural or artificial objects or tactical positions to confuse, mislead, or evade the enemy. With the exception of medical units, sustainment brigade units use camouflage to conceal operations and the identity of critical assets.

## OBSTACLES

B-52. Obstacles slow, impede, or channel enemy movement and incursion. They buy time until reaction forces can deploy or a response force can arrive. Effective use of obstacles involves sound counter-mobility planning and early warning. Obstacles in urban environments are as important as in the field. Strategically placed obstacles provide protection against terrorist access to buildings.

## AIR AND MISSILE DEFENSE

B-53. Air defense artillery (ADA) forces cannot provide dedicated air and missile defense (AMD) for all sustainment brigade assets in the AO. The commander positions brigade organizations to take advantage of coverage that available AMD forces provide. Using base clusters makes it possible for AMD units to cover more Brigade assets than if units disperse throughout the AO, but reduces the benefits of dispersion. Brigade assets identified AMD priorities that do not receive dedicated support are positioned to take advantage of the coverage provided by AMD units protecting higher-priority assets.

B-54. Passive air defense operations include the means a unit uses to avoid enemy detection, along with measures to minimize damage when attacked. Sustainment brigade units use OPSEC to conceal their location from enemy visual and electronic surveillance. Elements within base clusters disperse as much as possible. Dispersal along with field fortifications and obstacles significantly reduce casualties and damage from air and missile attack.

B-55. The joint security coordinator (JSC) coordinates with appropriate commanders and staffs to establish a reliable, responsive, and redundant early warning system from the joint-force level to the base level in the JSA. The JSC implements a standardized alert system throughout the JSA to ensure early warning and a coherent response to threats. BCT commanders are responsible for early warning and response systems within their assigned AOs.

B-56. Sustainment brigade personnel and air defenders share responsibility for protection of sustainment brigade assets. The sustainment brigade commander develops air and missile defense priorities, which are integrated into the TSC/BCT priorities. The air defense coordinator coordinates the use of available air and missile defense assets to protect the maximum number of priority assets. The ADA provides defensive fires and sustainment brigade units employ self-defense measures to defeat enemy air and missile attacks. The sustainment brigade also integrates air and missile defense coverage into its planning for terrain management and movement control.

## **SECTION VI – CONVOY SECURITY**

B-57. The most serious threat faced by the deployed sustainment brigade elements occurs when moving. The sustainment brigade must coordinate with maneuver, military police, and medical units operating in the AO for additional security capability, medical support, and/or route security assessments (see FM4–01.45).

B-58. Movement control always includes convoy defense considerations. Supply routes are assumed not to be secure on a high threat area. Therefore, convoy movements between supported unit areas are combat operations. The TSC and supported unit commanders and staffs work together to integrate defensive capabilities into convoys. Adequate convoy security depends on two critical components. These are thorough staff planning to counter enemy plans and capabilities and individual Soldier training to counteract enemy action. All convoy personnel must be familiar with published rules of engagement and local tactics, techniques, and procedures developed for the current situation on the convoy route.

B-59. The convoy commander ensures that troops are trained in convoy defense techniques. The damage a convoy prevents or incurs when attacked often depends on the adequacy of convoy defense training. It also depends on the route and timing of the convoy in relation to the enemy situation and the adequacy of the intelligence and information convoy leaders receive in advance of the operation. The following paragraphs discuss in the broadest of terms the considerations of convoy protection.

B-60. There is no such thing as an administrative move on the noncontiguous operational area. Once outside the base perimeter you have a tactical convoy. A tactical convoy is a deliberately planned combat operation. Its mission is to move personnel and/or cargo via a group of ground transportation assets in a secure manner to or from a target destination. Tactical convoys operate under the control of a single commander in a permissive, uncertain, or hostile environment. Tactical convoys should always have access to the COP and be characterized by an aggressive posture, agility, and unpredictability. There should never be less than two personnel in the cab, one to drive and one for protection.

B-61. Each tactical convoy must be prepared to take appropriate action in the face of ambush and once contact is made based on rules of engagement and TTPs. Training, experience, and unit SOPs will accelerate tactical convoy preparation and prepare unit personnel to take appropriate actions on contact.

B-62. Standard troop leading procedures (modified to reflect convoy operations) are included in FM 4–01.45, Multi-Service Tactics, Techniques and Procedures for tactical convoy operations and should be used to ensure all planning elements are considered when preparing to conduct convoy operations.

### **MOVEMENT CORRIDORS**

B-63. The Maneuver Enhancement Brigade (MEB) is a multifunctional headquarters, task organized according to METT-TC that provides security and protection within its assigned areas. The sustainment brigade is likely to operate within a MEB AO and it will rely on the protection MEB elements provide throughout designated movement corridors.

B-64. A movement corridor (MC) is part of a layered and integrated security approach to LOC security. Layered security constitutes concentric rings that increase in survivability and response measures. The first ring (the center ring) being the ability of every convoy to defeat a Level I threat and to delay a Level II threat. The next ring (middle ring) provides the increased security/protection capability in support of the center ring activities, capable of defeating Level I and Level II threats, and supports the defeat of Level III threats. The middle ring is also capable of integrating fires, CAS, MEDEVAC, safe havens, vehicle removal/recovery operations, and so forth in support of the center ring and central effort that is the MC concept. The final ring (the outer most ring) is the final ring of protection and brings with it the ability to defeat all level of threats through the integration of all joint capabilities.

B-65. An MC is a protected LOC that connects two support areas. Within the MC are main and alternate roads, railways, and/or inland waterway supply routes used to support operations. Within an AO, there is an MC network that consists of multiple MCs that connect inter-theater APOD and SPOD; intra-theater Aerial Port of Embarkation and APODs; operational level support, distribution, and storage areas; and brigade support areas. The MEB is responsible for tactical LOC operations and security within its AO and, as assigned, within its higher headquarters AO. The width and depth of an MC will be dependent on METT-TC factors and the commanders' guidance.

B-66. The establishment of an MC network is the result of applying multiple functions and establishing required command, control, and support relationships. The collective integration and synchronization of units, capabilities, and facilities will provide a comprehensive three-dimensional protection capability for the designated LOCs, the unit and convoy movements on the LOCs, and the units supporting LOC and movement operations. A fully developed MC will consist of military police units providing route regulation and enforcement, straggler and dislocated civilian control, area and route security, convoy escort, response force operations, and logistical units conducting and managing movement control. Supporting functions include units and capabilities for vehicle recovery and storage, cargo transfer, refueling, road maintenance and repair, MC safe haven support facility construction and repair, CBRN detection and response, aerial reconnaissance, and medical treatment and evacuation.

B-67. The constitution of an MC and the required units and capabilities to support MC operations are not new to the Army. What is new is the requirement to doctrinally codify a holistic, fully integrated, and synchronized LOC and convoy protection system. The requirement to establish MC doctrine is based on the combination of, and the complexity resulting from a asymmetrical operational environment, conducting threat-based operations with minimal regard for occupying terrain, combat forces by-passing up to company-sized mechanized forces, combating new categories of threat forces, smaller stockpiles with an anticipatory "push" logistics system, and conducting simultaneous offense, defense, and stability operations. The establishment of an MC network and the allocation of resources to conduct MC protection and support operations is a command function that must be synchronized with Army, joint, multinational, and HN forces supporting MC operations and the applicable movement control agencies.

B-68. The sustainment brigade S-3 coordinates with the MEB when planning tactical convoys through movement corridors. This may be done through movement control elements collocated with the MEB or the division transportation officer. Figure B-1 depicts notional movement corridors established by the MEB.

B-69. The MC concept provides a solution to current and future force requirements for ground LOC movement as it pertains to a comprehensive approach to increasing the survivability of land forces in the conduct of full spectrum operations. This concept provides for continuous support in keeping the MC secure and operational; thereby, directly increasing the mobility, survivability, sustainability, and responsiveness of combat enablers in support of all operational effort.

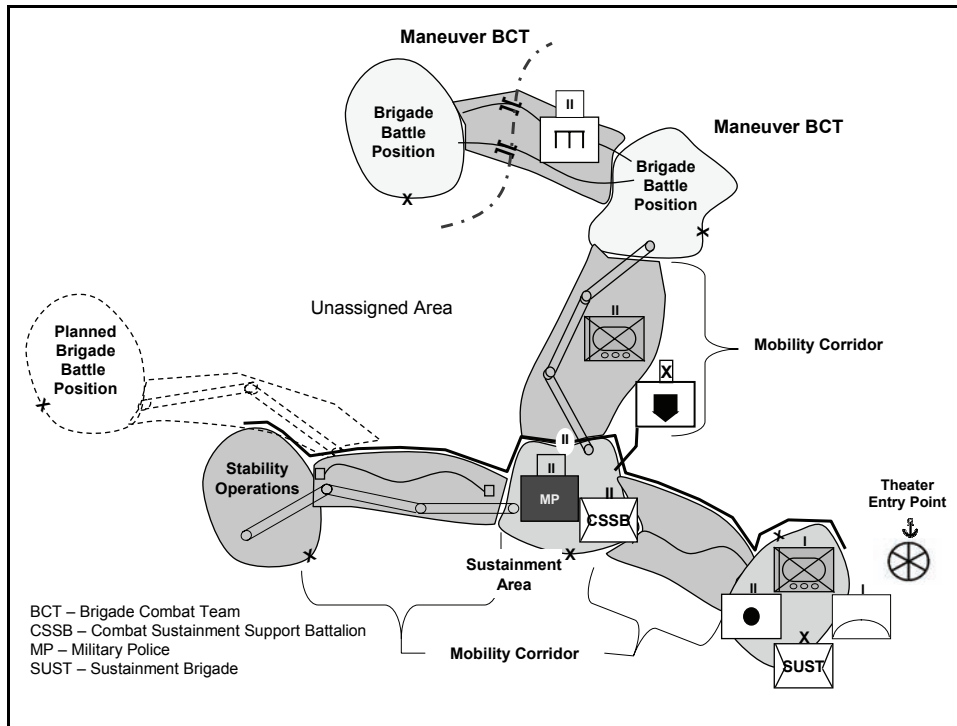

**Figure B-1. Notional Mobility Enhancement Brigade Movement Corridors**

### Main Supply Routes (MSRs)/Alternate Supply Routes (ASRs)

B-70. MSRs are routes designated within the MEB's or higher headquarters AO upon which the bulk of sustainment traffic flows in support of operations. An MSR is selected based on the terrain, friendly disposition, enemy situation, and scheme of maneuver. Supply routes are selected by the MEB S-4 in coordination with the BSB support operations officer and MEB S-3. They also plan ASRs for use if a MSR is interdicted by the enemy or becomes too congested. In the event of CBRN contamination, either the primary or alternate MSR may be designated as the dirty MSR to handle contaminated traffic. All ASRs must meet the same criteria as the MSR. MPs assist with regulating traffic and engineer units maintain routes. Security of supply routes in a noncontiguous AO may require the MEB commander to commit non-logistics resources.

B-71. Some route considerations are:

- Location and planned scheme of maneuver for subordinate forces to include combined arms forces, artillery units, and other forces moving through the MEB's AO.
- Route characteristics such as route classification, width, obstructions, steep slopes, sharp curves, and type roadway surface.
- Two-way, all-weather trafficability.
- Weight classification of bridges and culverts.
- Requirements for traffic control such as at choke points, congested areas, confusing intersections, or along built-up areas.
- Number and locations of crossover routes from the MSR to ASRs.
- Requirements for repair, upgrade, or maintenance of the route, fording sites, and bridges.
- Route vulnerabilities that must be protected. This may include bridges, fords, built-up areas, and choke points.
- Enemy threats such as air attack, conventional and unconventional tactics, explosive hazards, ambushes, and chemical strikes.

- Known or likely locations of enemy penetrations, attacks, chemical strikes, or obstacles.
- Known or potential civilian/refugee movements that must be controlled or monitored.

## LAYERED CONVOY PROTECTION

B-72. The tactical convoy's physical security elements are composed of three layers:

- Organic security elements.
- Convoy escorts.
- Corridor security.

B-73. The organic security element is the responsibility of the convoy commander. These assets (personnel, weapons, and vehicles) are taken from the organic assets of the unit conducting the convoy operation. Vehicles selected for this mission should be fast, maneuverable, and hardened to the extent possible (these vehicles are known as "gun trucks"). Crew served weapons, automatic weapons, and grenade launchers mounted on these gun trucks provide suppressive fire as the convoy initially responds to an ambush.

B-74. Convoy escorts may be provided by any organization tasked to provide convoy security. These organizations may include MPs, CAS, and/or security detachments from a maneuver element. The mission of the convoy escort is to provide protection from direct fire and complex ambushes. Convoy escort elements may be used as reconnaissance ahead of the convoy and/or as a trail security element. Either armor or mechanized units provide greater fire power for the escort mission. See FM 4-01.45 for suggested employment of ground and CAS convoy escort assets. Corridor security is the responsibility of the BCT or MEB whose AO includes the convoy route.

## CONVOY COMMUNICATION

B-75. Radio communication is vital to the support the convoy. A convoy commander needs to consider and plan for the following:

- MEDEVAC operations.
- Internal convoy vehicle to vehicle communications.
- Communications with security vehicles (gun trucks and/or convoy escorts).
- External communications to higher headquarters, quick reaction force, artillery support.

B-76. Alternate means of communication should be planned for the following:

- Internal to vehicle.
- Between vehicles.
- When dismounted due to ambush or IED.
- Radios capable of secure communications are used in convoys. Three types of communications must be considered and planned for. Alternate means of communications (vehicle signal system, hand and arm signals, pyrotechnics, and so on) should also be planned.

## MOUNTED TACTICS

B-77. The four principles of mounted tactics for convoys are:

- 360 degree security – situational awareness, interlocking fires, mutual support.
- Deterrence – aggressive posture, display a willingness to engage.
- Agility – Ability to adapt to environment and conditions.
- Unpredictability – No observable routine.

B-78. Every participant in the convoy must understand the areas in which they are responsible for observing and into which they must fire in the event of enemy contact. Interlocking fires and mutually supporting fires are ensured to the extent that fratricide considerations allow.

## **DANGER AREAS**

B-79. Intersections, ramps, traffic circles, over and underpasses, rest halts, or halts to recover disabled vehicles can all be danger areas for convoys. See FM 4-01.45 for TTPs in dealing with these areas.

## **Battle Drills**

B-80. Battle drills are the pre-planned, rehearsed responses to contact. FM 4-01.45 provides a simple decision matrix for reaction to contact and examples of how convoy participants might respond. Battle drills on how to react to convoy ambushes must be developed and rehearsed.

## **IMPROVISED EXPLOSIVE DEVICES (IEDS) AND VEHICLE BORNE IEDS (VBIEDS)**

B-81. IEDs are one of the greatest threats to convoys and are often used to initiate an ambush. Convoy personnel should always expect an ambush immediately following an IED detonation. Convoy commanders should brief convoy personnel on the latest IED threat: what types of IEDs are being used and where they have previously been emplaced along the route.

B-82. IEDs and VBIEDs represent an attractive attack weapon for asymmetrical threat forces. They can inflict substantial damage to convoys (equipment and personnel) while providing the threat with very limited exposure counter-attack by US forces.

B-83. IEDs are rigged from any explosive materiel available to threat forces and detonated by timing device, trip wire or pressure trigger, or are command detonated. IEDs are most easily emplaced during periods of limited visibility making morning periods exceptionally dangerous for exposure to IEDs. IEDs are often used as the opening weapon in an ambush. Convoy participants must be prepared to counter an assault by direct fire from hidden roadside positions immediately following an IED encounter.

B-84. IED battle drills are provided in FM 4-01.45.

B-85. FM 4-01.45 contains checklist for planning tactical convoys, briefing formats for the convoy commander to use during convoy briefings, and formats for en route and after action reports.

## **SECTION VII – BASES AND BASE CLUSTERS**

B-86. The sustainment brigade must integrate its HQ and subordinate elements FP plans into the base and base cluster defense plans. These plans are integrated with the defense plans of the MEB or BCT having the overall responsibility for the AO, and are copied to the higher sustainment commander. This defense method protects elements from level I threats in their assigned areas. Commanders ensure all bases and base clusters in their AOs train and prepare for their roles. Cooperation and coordination elements are critical.

B-87. Bases and base clusters form the basic building block for planning, coordinating, and executing base defense operations. The sustainment brigade S-3, with input from the sustainment brigade SPO, organizes units occupying the support HQ AO into base clusters. The sustainment brigade SPO recommends appointments of base or base cluster commanders from units in the cluster to the sustainment brigade S-3. The base cluster commander is usually the senior commander in the base cluster. The base cluster commander forms a base cluster defense operations center (BCOC) from the staff and available base assets.

B-88. A base may be a single-service or a joint-service base. The base cluster commander appoints the base commanders. Base commanders form base defense operating centers (BDOCs).

B-89. Within the base cluster, three commanders have distinct responsibilities. These three — the individual unit commander, the base commander, and the base cluster commander — are discussed below. Non-sustainment units residing within a base which a sustainment brigade commands will have a command relationship and responsibilities established by order to the sustainment brigade for protection.



## INDIVIDUAL UNIT COMMANDERS

B-90. The commanders of units in a base are responsible for the following:

- Participating in base defense planning.
- Providing, staffing, and operating base defense facilities in accordance with base defense plans.
- Conducting individual and unit training to ensure their forces' readiness to perform their assigned tasks in defense of the base.
- Providing appropriate facilities and essential personnel for the BDOC and the base commander.
- Providing liaison personnel to advise the base commander on matters peculiar to their units.
- Providing internal security of the base.
- Providing communications systems, including common-user communications, within the command.

B-91. Sustainment brigade units use observation posts, listening posts, or unattended sensors on likely avenues of approach to collect intelligence on threat activity. In areas where the populace is friendly, local law enforcement or government agencies can provide information on threats in the area. BCOCs implement an integrated warning plan within their cluster and with adjacent bases or base clusters.

## BASE COMMANDER

B-92. The base commander is responsible for base security and defense. All forces assigned to the base are under OPCON for base defense purposes. The base commander's responsibilities for base defense include:

- Establishing a BDOC from available base assets to serve as the base's tactical operations center (TOC) and focal point for security and defense. The BDOC assists with planning, directing, coordinating, integrating, and controlling base defense efforts.
- Establishing an alternate BDOC from base resources or, if base assets are not available, designating a HQ element from units dedicated to the base for its local defense.
- Planning for including transient units by ensuring that base defense plans include provisions for augmenting the regularly assigned base defense forces with units present at the base during periods of threat.

## BASE CLUSTER COMMANDER

B-93. The base cluster commander is responsible for securing the base, coordinating the defense of bases within the base cluster, and integrating base defense plans into a base cluster defense plan. Specific responsibilities include:

- Establishing a BCOC from the staff and available base or base cluster assets to serve as the base cluster's TOC and focal point for planning, directing, coordinating, integrating, and controlling base cluster defense activities.
- Providing appropriate facilities, housing, and services for necessary liaison personnel from bases from within the cluster.

## BASE AND BASE CLUSTER DEFENSE PLAN

B-94. Base and base cluster commanders develop and implement comprehensive defense plans to protect their support capability. The defense plan includes measures to detect, minimize, or defeat level I and defend level II threats. To maximize mutual support and prevent fratricide, the base and base cluster commanders coordinate defense plans with adjacent base and base clusters and joint, multinational, and HN forces. The sustainment brigade S-3 ensures that all plans conform to the overall TSC or BCT security plans.

## AREA DAMAGE CONTROL

B-95. Commanders of bases and installations within the JSA coordinate requirements for area damage control (ADC) with the JSC through their respective chains of command. Commanders establish priorities for ADC missions as part of their planning process at the base or installation level. All units are responsible for providing ADC within their base or installation to the extent of their capabilities.

B-96. The sustainment brigade takes ADC measures before, during, and after hostile action or natural disasters to reduce the probability of damage, to minimize its effects, and to reestablish normal operations. Necessary repair begins after the damage is contained.

B-97. The sustainment brigade and its assigned subordinate support HQ commanders anticipate ADC operations. The SPO and S-4 section develop the ADC plan based on the policies and priorities of the higher HQ (TSC or BCT). Plans highlight anticipated requirements for ADC that may exceed the capabilities of organic resources and the priority of ADC missions. US and HN engineers have a major portion of the capability to perform these tasks.

B-98. Other forces and assets that contribute to the ADC mission include—

- Ordnance.
- MP.
- Chemical.
- CA.
- Maintenance.
- Medical
- Signal.
- Supply.
- Transportation.
- Transiting units.

HNS can be a vital resource for ADC in the AO. Early HNS identification and coordination are essential to supplement ADC efforts. Responsibilities and support from HN assets are negotiated at theater level and are part of the status-of-forces agreements and treaties.

## Appendix C

# Logistics Reporting

### LOGISTICS REPORT

C-1. The logistics report is the internal status report that identifies logistics requirements, provides visibility on critical shortages, projects mission capability, and provides input to the common operational picture. In order to provide the support, unit commanders must coordinate closely with supporting and supported units using the logistics report. The report is forwarded from a unit to its higher headquarters and its supporting logistics headquarters. The logistics report will enable the higher command and support units to make timely decisions, prioritize, cross level, and synchronize the distribution of supplies to sustain units at their authorized levels.

C-2. The logistics report is the primary product used throughout the brigade and at higher levels of command to provide a logistics snapshot of current stock status, on-hand quantities, and future requirements. The logistics report gives the logistician the information and flexibility to manage requirements internally at the lowest level to ensure mission accomplishment.

C-3. The logistics report incorporates the organizational and DS supplies starting at company level. The intent is to identify the shortages at the lowest level first and then project the requirement to the next higher command and the support unit. The format for the current force should incorporate organizational and direct support data on the same report to enable logisticians to fix issues at the lowest levels. While the format of the logistics report has been controlled by SOP in the past, a new standardized spreadsheet based logistics report is under development. Data will be input and accessed locally through NIPRNET or BCS3. Figure C-1 through Figure C-5 are examples of logistics report spreadsheets.

C-4. The logistics report is not intended as a means of gathering the same information available in a logistics STAMIS, nor to serve as the primary means of requisitioning commodities managed by a logistics STAMIS. The logistics report format is based upon METT-TC and should not overwhelm subordinate units with data submission requirements. A report that grows too cumbersome will overwhelm staffs and fail in high operational pace. It is important that this report is standardized and that units always provide input, regardless of their level of support.

C-5. Additional reports such as the maintenance readiness report, munitions report, and petroleum report should not be added to reporting requirements to subordinate units below division-level when STAMIS and logistics report information satisfy information requirements.

C-6. **Company Level:** At company level, the 1SG or designated representative is responsible for gathering the information from the platoon sergeants and submitting a consolidated report to the battalion S-4. The 1SG can direct cross leveling between platoons and forecast requirements based on current balances and upcoming mission requirements. Some possible details to include in the logistics report are systems with an operational readiness rate below 60 percent, changes to anticipated expenditure rates, Class V status, and significant incidents. The primary means of gathering this information and submitting it to the battalion S-4 is through the logistics report in FBCB2.

C-7. **Battalion Level:** The battalion S-4 is responsible for collecting reports from all companies and ensuring reports are complete, timely, and accurate. The battalion S-4 makes the determination on which units receive which supplies. That decision is based on mission priority and the battalion commander's guidance. Upon receiving the logistics report, the company then validates external supplies to fulfill its requirements (where capable) and provides input to the logistics report on the adjusted balance of external supplies. The adjusted balances of external supplies are added to the logistics report and returned to the battalion S-4. The company also provides a coordination copy to the BSB's SPO or CSSB's SPO. The

battalion may include information such as STAMIS connectivity status, route and transportation node status, and distribution platform capabilities. The battalion S-4 now has the complete logistics report and forwards this report to the brigade S-4.

C-8. **Brigade Level:** The brigade S-4 is responsible for collecting reports from all battalions, including the BSB logistics report on internal supplies. The S-4 ensures that reports are complete, timely, and accurate. Prior to the brigade S-4 forwarding a consolidated report to the BSB SPO, the brigade S-4, with brigade executive officer's concurrence, makes the determination of which units receive which supplies. Their decision is based upon mission priority and the brigade commander's guidance. Upon receiving the logistics report, the SPO conducts a Brigade Logistics Synchronization meeting. The BSB SPO then disseminates the external supplies to fulfill battalion requirements (where capable), synchronizes distribution, and provides input to the logistics report. The SPO input to the logistics report focuses on the adjusted balance of external supplies owned by the BSB and forecasting resupply requirements into the brigade. Some other possible information to include would be stockage levels, inventory on hand and in bound, and supply performance statistics. The adjusted balances of external supplies and forecasted requirements are added to the logistics report and returned to the brigade S-4. The BSB SPO also provides a courtesy copy to the supporting sustainment brigade SPO. The brigade S-4 now has the complete logistics report and forwards this report to the division G-4. Once validated, the logistics report is used to update the synchronization matrix. The end result should be a refined logistics report containing an accurate forecast of logistics requirements for use by operational level support organizations. The updated logistics report and logistics synchronization matrix complement paragraph 4 and annex I of the operations order (OPORD), or fragmentary order (FRAGO).

C-9. **Division Level:** The division G-4 is responsible for collecting reports from all task organized brigades and ensuring reports are complete, timely, and accurate. The division may add information such as changes to theater opening and changes to anticipated expenditure rates. The division G-4 has a complete logistics report and forwards this report to the next highest level of command and then forwards a logistics report for coordination to the supporting TSC/ESC SPO.

C-10. The following are sample reports from the BCS3 Logistics Reporting Tool.

---

Note: See charts in LRT file.

---

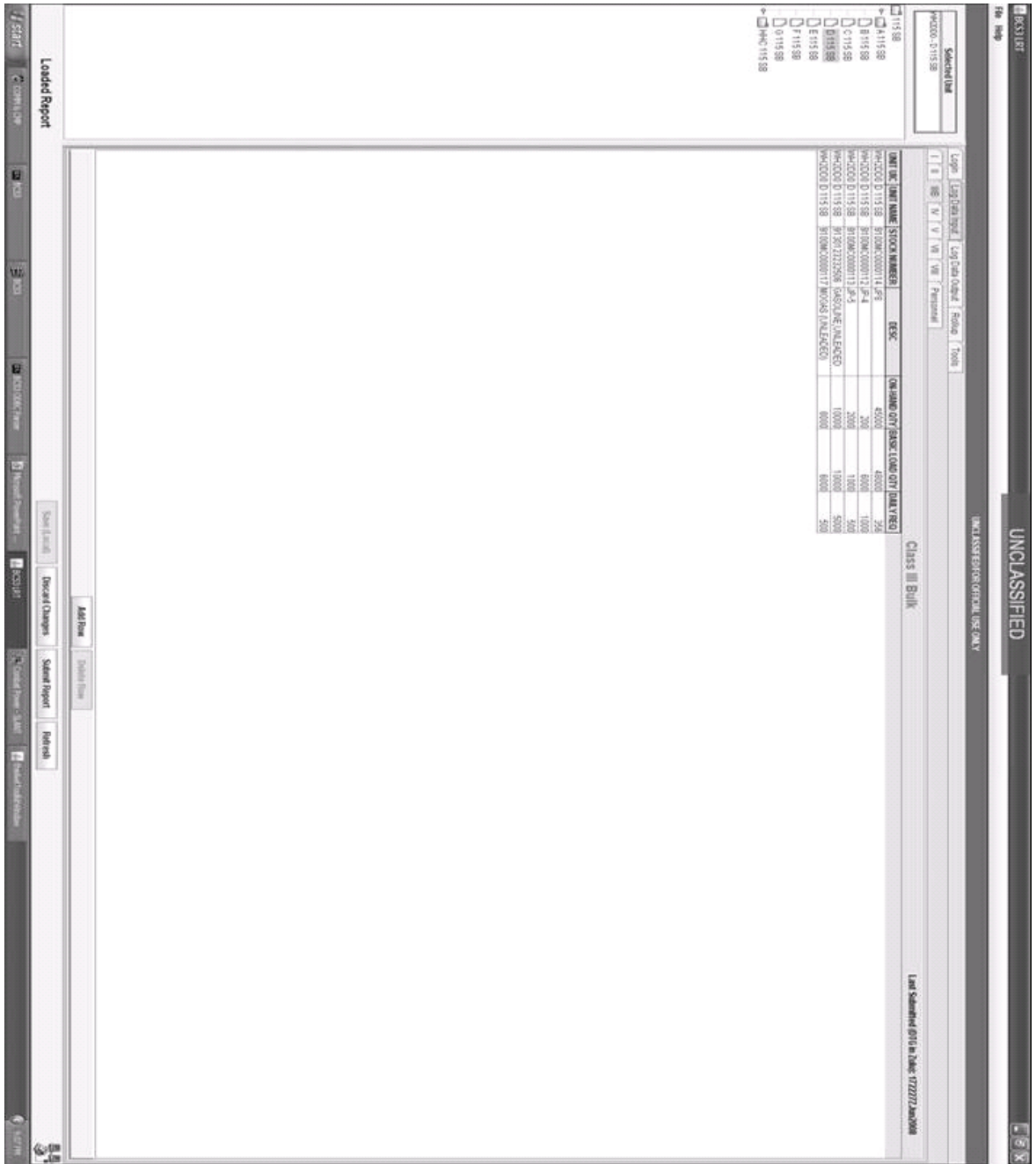

Figure C-1. Sample Class III (B) Input Report



Combat Power - SLANT

File View Tools Windows Refresh I:\D:\Libe\new\organc\_id\_347504T\_20084.../115 SR TEL: 115SR.COMMUNERS 46-cf-010: 1821122LX08

Ammunition (LOSTAT) - 10 Recs

AMMO	LOSTAT	115 SR	HMC 115 SR	G 115 SR	F 115 SR	E 115 SR	O 115 SR	B 115 SR	A 115 SR	C 115 SR
CARTRIDGE 5.56M...	628	-	-	-	-	628	-	-	-	-
CARTRIDGE 5.56M...	443	-	-	-	-	443	-	-	-	-
CARTRIDGE 7.62M...	200	-	-	-	-	200	-	-	-	-
CARTRIDGE 7.62M...	1,800	-	-	-	-	1,800	-	-	-	-
CTG 5.56MM BALL L...	100	-	-	-	-	100	-	-	-	-
CTG 7.62MM M973...	400	-	-	-	-	400	-	-	-	-
CTG 7.62MM M82 8...	4,000	-	-	-	-	4,000	-	-	-	-
DUWNY CARTRIDGE...	224	-	-	-	-	224	-	-	-	-
RESIDUE - POSS S...	2,300	-	-	-	-	2,300	-	-	-	-
SIMULATOR BOOBY...	34	-	-	-	-	34	-	-	-	-

Personnel (STAMNS) - 3 Recs

PGS	115 SR	HMC 115 SR	G 115 SR
AUTH	-	-	-
ASSGN	-	-	-
POV	-	-	-

Equipment (LOSTAT) - 1 Rec

EQUIP	LOSTAT	115 SR	HMC 115 SR	G 115 SR	F 115 SR	E 115 SR	O 115 SR	B 115 SR	A 115 SR	C 115 SR
TRUCK UTILITY CAB...	3	100%	-	-	-	-	-	-	-	-

Fuel (LOSTAT) - 5 Recs

FUEL	115 SR	HMC 115 SR	G 115 SR	F 115 SR	E 115 SR	O 115 SR	B 115 SR	A 115 SR	C 115 SR
GASOLINE UNLEADED	10,000	-	-	-	-	10,000	-	-	-
JP-4	200	-	-	-	-	200	-	-	-
JP-5	2,000	-	-	-	-	2,000	-	-	-
JP8	45,000	-	-	-	-	45,000	-	-	-
MODAS UNLEADED	8,000	-	-	-	-	8,000	-	-	-

Done loading data from server.

Figure C-3. Sample Combat Power Report

	A	B	C	D	E	F	G	H	I	J	K	L
	UNIT UIC	UNIT NAME	STOCK NUMBER	DESC	ON-HAND QTY	BASIC LOAD QTY	DAILY REQ					
1												
2	WH2000	D 115 SB	9100MC000114	JP8	45000	45000	356					
3	WH2000	D 115 SB	9100MC000112	JP4	200	6000	1000					
4	WH2000	D 115 SB	9100MC000113	JP-5	2000	1000	500					
5	WH2000	D 115 SB	9130123232506	GASOLINE UNLEADED	10000	10000	5000					
6	WH2000	D 115 SB	9100MC000117	MCGAS (UNLEADED)	6000	6000	600					
7												
8												
9												
10												
11												
12												
13												
14												
15												
16												
17												
18												
19												
20												
21												
22												
23												
24												
25												
26												
27												
28												
29												
30												
31												
32												
33												
34												
35												
36												

Figure C-4. Sample Class III (b) Excel Format



A	B	C	D	E	F	G	H
UNIT UIC	UNIT NAME	DODIC	DESC	DODIC ON-HAND QTY	BASIC LOAD QTY		
1	WH2000	AA39	CTG 7.62 MM M82 BALL	400	400		
2	WH2000	A135	DUMMYY CARTRIDGE 7.62MM M63 IN CART	234	234		
3	WH2000	A164	CARTRIDGE 7.62MM A-BAL 1-TRACER LINKED 750BELT (MINIGUN)	200	400		
4	WH2000	A072	CARTRIDGE 5.56MM TRACER M196 10 PER CLIP	443	443		
5	WH2000	A110	CTG 7.62MM M82 840 BX	4000	4000		
6	WH2000	ZM43	RESIDUE - POSS 5.56MM BRASS	2300	2800		
7	WH2000	A062	CTG 5.56MM BALL LINK	100	200		
8	WH2000	AZ36	CARTRIDGE 7.62MM, BLANK (13A2), L	1800	2000		
9	WH2000	A059	CARTRIDGE 5.56MM BALL M855 10 PER CLIP	678	787		
10	WH2000	L598	SIMULATOR BOOBY TRAP M117 FLASH	34	55		
11	WH2000						
12							
13							
14							
15							
16							
17							
18							
19							
20							
21							
22							
23							
24							
25							
26							
27							
28							
29							
30							
31							
32							
33							
34							
35							
36							

Figure C-5. Sample Class V Excel Format

**This page intentionally left blank.**

# Glossary

## SECTION I – TERMS AND DEFINITIONS

<b>ABCS</b>	Army Battle Command System
<b>ADA</b>	air defense artillery
<b>A/DACG</b>	arrival/departure airfield control group
<b>ADC</b>	area damage control
<b>AFSBN</b>	Army field support battalion
<b>AFSB</b>	Army field support brigade
<b>AHLTA-T</b>	Armed Forces Health Longitudinal Technology Application - Theater
<b>AHS</b>	Army health system
<b>AIT</b>	automated identification technology
<b>ALT</b>	acquisition, logistics, and technology
<b>AMC</b>	Air Mobility Command
<b>AMD</b>	air and missile defense
<b>AO</b>	area of operations
<b>AOE</b>	Army of excellence
<b>AOR</b>	area of responsibility
<b>APOD</b>	aerial port of debarkation
<b>APOE</b>	aerial port of embarkation
<b>APS</b>	Army pre-positioned stocks
<b>AR</b>	Army regulation
<b>ARFOR</b>	Army forces
<b>ARFORGEN</b>	Army force generation
<b>ARSOF</b>	Army special operations forces
<b>ASA(ALT)</b>	Assistant Secretary of the Army for Acquisition, Logistics, and Technology
<b>ASA</b>	ammunition support activity
<b>ASAS</b>	All Source Analysis System
<b>ASC</b>	Army Sustainment Command
<b>ASCC</b>	Army Service component command
<b>ASL</b>	authorized stockage list
<b>ASP</b>	ammunition supply point
<b>ASR</b>	alternate supply route
<b>ATHP</b>	ammunition transfer and holding point
<b>AUTL</b>	Army Universal Task List
<b>avn</b>	Aviation
<b>BAO</b>	brigade ammunition officer

<b>BCOC</b>	base cluster operations center
<b>BCS3</b>	Battle Command Sustainment Support System
<b>BCT</b>	brigade combat team
<b>bde</b>	Brigade
<b>BDOC</b>	base defense operating center
<b>BFSB</b>	battlefield surveillance brigade
<b>BLOS</b>	beyond line of sight
<b>BLST</b>	brigade logistics support team
<b>bn</b>	Battalion
<b>BSB</b>	brigade support battalion
<b>BSS</b>	brigade surgical station
<b>BUB</b>	battle update briefing
<b>C2</b>	command and control
<b>CA</b>	civil affairs
<b>CAISI</b>	combat service support automated information system interface (legacy term)
<b>CAPS</b>	Commercial Accounts Payable System
<b>CAS</b>	close air support
<b>CBM</b>	combat service support bridge module (legacy term)
<b>CBRN</b>	chemical, biological, radiological, nuclear
<b>CCBN</b>	contingency contracting battalion
<b>CCIR</b>	commander's critical information requirement
<b>CCM</b>	combat service support client module (legacy term)
<b>CCT</b>	contingency contracting team
<b>CEA</b>	captured enemy ammunition
<b>CLS</b>	combat lifesaver
<b>CMMC</b>	corps materiel management center
<b>CMO</b>	civil-military operations
<b>CONUS</b>	continental United States
<b>COP</b>	common operational picture
<b>COR</b>	contracting officer representative
<b>COTS</b>	commercial off-the-shelf
<b>CP</b>	command post
<b>CRC</b>	component repair company
<b>CRSP</b>	centralized receiving and shipping point
<b>CSSA</b>	consolidated supply support activity
<b>CSB</b>	contracting support brigade
<b>CSC</b>	convoy support center
<b>CSM</b>	command sergeant major
<b>CSNP</b>	causeway section, nonpowered
<b>CSR</b>	controlled supply rate

---

<b>CSSAMO</b>	combat service support automation management office (legacy term)
<b>CSSB</b>	combat sustainment support battalion
<b>CTASC</b>	corps/theater automated data processing system center
<b>CUL</b>	common user logistics
<b>DA</b>	Department of the Army
<b>DAO</b>	division ammunition officer
<b>DBCAS</b>	Database Commitment Accounting System
<b>DC</b>	distribution center
<b>DCO</b>	deputy commanding officer
<b>DCST</b>	Defense Logistics Agency contingency support team
<b>DDS</b>	Defense Deployable System
<b>DHCP</b>	dynamic host configuration protocol
<b>DIMHRS</b>	Defense Integrated Military Human Resources System
<b>DIRLAUTH</b>	direct liaison authorized
<b>DISCOM</b>	division support command
<b>DJMS</b>	Defense Joint Military Pay System
<b>DLA</b>	Defense Logistics Agency
<b>DMMC</b>	division materiel management center
<b>DOD</b>	Department of Defense
<b>DOS</b>	day of supply
<b>DOTMLPF</b>	doctrine, organization, training, material, leadership and education, personnel, facilities
<b>DS</b>	direct support
<b>DSN</b>	Defense Switched Network
<b>DSS</b>	division surgical section
<b>DTAS</b>	Digital Theater Accountability Software
<b>DTO</b>	division transportation office
<b>EAB</b>	echelons above brigade
<b>EEE</b>	early entry element
<b>EPLRS</b>	Enhanced Position Location and Reporting System
<b>EPW</b>	enemy prisoner of war
<b>ESC</b>	expeditionary sustainment command
<b>FBCB2</b>	Force XXI Battle Command, Brigade and Below
<b>FEU</b>	forty-foot equivalent unit
<b>FHP</b>	force health protection
<b>FM</b>	field manual; frequency modulation
<b>FMC</b>	financial management center
<b>FMCO</b>	financial management company
<b>FMI</b>	field manual, interim
<b>FMTF</b>	financial management tactical platform
<b>FMTV</b>	family of medium tactical vehicles

<b>FOB</b>	forward operating base
<b>FORSCOM</b>	United States Army Forces Command
<b>FRAGO</b>	fragmentary order
<b>FRCP</b>	flatrack collection point
<b>FSC</b>	forward support company
<b>G-1</b>	assistant chief of staff, personnel
<b>G-3</b>	assistant chief of staff, operations
<b>G-4</b>	assistant chief of staff, logistics
<b>G-6</b>	assistant chief of staff, signal
<b>G-8</b>	assistant chief of staff, resource management
<b>gal</b>	Gallon
<b>GATES</b>	Global Air Transportation Execution System
<b>GCC</b>	geographic combatant commander
<b>GCCS-A</b>	Global Command and Control System - Army
<b>GCSS-Army F/T</b>	Global Combat Support System – Army (Field/Tactical)
<b>GS</b>	general support
<b>HAZMAT</b>	hazardous material
<b>HBCT</b>	heavy brigade combat team
<b>HEMTT</b>	heavy expanded mobility tactical truck
<b>HET</b>	heavy equipment transport
<b>HF</b>	high frequency
<b>HHC</b>	headquarters and headquarters company
<b>HMMWV</b>	high mobility multipurpose wheeled vehicle
<b>HN</b>	host nation
<b>HNS</b>	host nation support
<b>HQ</b>	headquarters
<b>HR</b>	human resources
<b>HRSC</b>	human resources sustainment center
<b>HSS</b>	health service support
<b>IATS</b>	Integrated Automated Travel System
<b>IAW</b>	in accordance with
<b>IBCT</b>	infantry brigade combat team
<b>ICTC</b>	inland cargo transfer company
<b>ID</b>	identification
<b>IED</b>	improvised explosive device
<b>ILAR</b>	integrated logistics aerial resupply
<b>IPB</b>	intelligence preparation of the battlefield
<b>ISO</b>	International Office of Standardization
<b>ISSA</b>	inter-Service support agreement
<b>ITV</b>	in-transit visibility
<b>J-4</b>	logistics directorate of a joint staff

---

<b>JDDOC</b>	Joint Deployment Distribution Operations Center
<b>JFC</b>	joint force commander
<b>JLOTS</b>	joint logistics over-the-shore
<b>JMAO</b>	joint mortuary affairs office
<b>JNN</b>	joint network node
<b>JOA</b>	joint operations area
<b>JOPEs</b>	Joint Operation Planning and Execution System
<b>JP</b>	joint publication
<b>JSA</b>	joint security area
<b>JSC</b>	joint security coordinator
<b>JSOTF</b>	joint special operations task force
<b>JTF</b>	joint task force
<b>JTF-PO</b>	Joint Task Force – Port Opening
<b>km</b>	Kilometer
<b>km/h</b>	kilometers per hour
<b>LAN</b>	local area network
<b>LAP</b>	logistics assistance program
<b>LCMC</b>	life cycle management command
<b>LCOP</b>	logistics common operational picture
<b>LHS</b>	load-handling system
<b>LOC</b>	line of communications
<b>LOGCAP</b>	logistics civil augmentation program
<b>LOGSA</b>	logistics support activity
<b>LOS</b>	line of sight
<b>LOTS</b>	logistics over-the-shore
<b>LPB</b>	logistics preparation of the battlefield
<b>LSA</b>	logistics support area
<b>LSO</b>	logistics support officer
<b>LSV</b>	logistics support vessel
<b>MC4</b>	medical communications for combat casualty care
<b>MA</b>	mortuary affairs
<b>MACP</b>	mortuary affairs collection point
<b>MC</b>	movement corridor
<b>MCB</b>	movement control battalion
<b>MCS</b>	maneuver control system
<b>MCT</b>	movement control team
<b>MEB</b>	maneuver enhancement brigade
<b>MEDBDE</b>	medical brigade
<b>MEDEVAC</b>	medical evacuation
<b>MEDLOG</b>	medical logistics
<b>METL</b>	mission-essential task list

<b>METT-TC</b>	mission, enemy, terrain and weather, troops and support available, time available, civil considerations
<b>MHE</b>	materials-handling equipment
<b>MLC</b>	medical logistics company
<b>MLMC</b>	medical logistics management center
<b>MMC</b>	materiel management center
<b>MMT</b>	military mail terminal
<b>MOPP</b>	mission-oriented protective posture
<b>MP</b>	military police
<b>MRF</b>	manager review file
<b>MSC</b>	Military Sealift Command
<b>MSL</b>	military shipping label
<b>MSR</b>	main supply route
<b>MTF</b>	medical treatment facility
<b>MTS</b>	movement tracking system
<b>MTTP</b>	multi-Service tactics, techniques, and procedures
<b>MWR</b>	morale, welfare, and recreation
<b>NATO</b>	North Atlantic Treaty Organization
<b>NCO</b>	noncommissioned officer
<b>NETOPS</b>	network operations
<b>NIPRNET</b>	Nonsecure Internet Protocol Router Network
<b>NGO</b>	nongovernmental organization
<b>OCONUS</b>	outside the continental United States
<b>OEF</b>	Operation ENDURING FREEDOM
<b>OIF</b>	Operation IRAQI FREEDOM
<b>OPCON</b>	operational control
<b>OPLAN</b>	operation plan
<b>OPORD</b>	operation order
<b>OPSEC</b>	operations security
<b>PAO</b>	public affairs office(r)
<b>PBO</b>	property book office
<b>PBUSE</b>	property book unit supply enhanced
<b>PCC OTC</b>	Paper Check Conversion Over The Counter
<b>PE</b>	personal effects
<b>PEO</b>	program executive officer
<b>PLS</b>	palletized load system
<b>PM</b>	project manager
<b>PMT</b>	port management team
<b>POL</b>	petroleum, oil, and lubricants
<b>PPC</b>	personnel processing center
<b>PPTO</b>	petroleum pipeline and terminal operation



---

<b>PSA</b>	port support activity
<b>PSC</b>	petroleum support company
<b>PWS</b>	performance work station
<b>QM</b>	quartermaster
<b>QSC</b>	quartermaster support company
<b>R5</b>	reception, replacement, rest and recuperation, return to duty, redeployment
<b>RF</b>	radio frequency
<b>RFID</b>	radio frequency identification
<b>RIC-GEO</b>	routing identifier code - geographic
<b>RO</b>	replenishment operation
<b>RO/RO</b>	roll on/roll off
<b>RSO</b>	reception, staging, onward movement
<b>RSOI</b>	reception, staging, onward movement, integration
<b>S&amp;S</b>	supply and services
<b>S-1</b>	personnel staff officer
<b>S-2</b>	intelligence staff officer
<b>S-3</b>	operations staff officer
<b>S-4</b>	logistics staff officer
<b>S-6</b>	signal staff officer
<b>SAAS-ATHP</b>	standard Army ammunition system – ammunition transfer and holding points
<b>SAAS-ASP</b>	standard Army ammunition system – ammunition supply points
<b>SAAS-DAO</b>	standard Army ammunition system – division ammunition officer
<b>SAAS-MMC</b>	standard Army ammunition system – materiel management center
<b>SAAS-MOD</b>	standard Army ammunition system – modernized
<b>SAMS</b>	Standard Army Maintenance System
<b>SAMS-E</b>	Standard Army Maintenance System - Enhanced
<b>SAR</b>	satellite access request
<b>SARSS</b>	standard Army retail supply system
<b>SBCT</b>	Stryker brigade combat team
<b>SB(SO)(A)</b>	sustainment brigade (special operations) (airborne)
<b>SDDC</b>	Surface and Deployment Command
<b>SIPRNET</b>	SECRET Internet Protocol Router Network
<b>SJA</b>	staff judge advocate
<b>SLCR</b>	shower, laundry, and clothing repair
<b>SMC</b>	support maintenance company
<b>SMM</b>	shipment management module
<b>SOF</b>	special operations forces
<b>SOP</b>	standing operating procedures
<b>SPO</b>	support operations

<b>SPOD</b>	seaport of debarkation
<b>SPOE</b>	seaport of embarkation
<b>SSA</b>	supply support activity
<b>SSR</b>	system support representative
<b>STAMIS</b>	standard Army management information system
<b>STANAG</b>	standardization agreement (NATO)
<b>STB</b>	special troops battalion
<b>ston</b>	short ton
<b>SVC</b>	stored value card
<b>TAA</b>	tactical assembly area
<b>TACON</b>	tactical control
<b>TACSAT</b>	tactical satellite
<b>TAMMIS-MEDSUP</b>	Theater Army Medical Management Information System – Medical Supply
<b>TAS</b>	theater address system
<b>TAV</b>	total asset visibility
<b>TCACCIS</b>	Transportation Coordinator’s Automated Command and Control Information System
<b>TCAIMS</b>	Transportation Coordinators Automated Information for Movement System
<b>TCF</b>	tactical combat force
<b>TCN</b>	transportation control number
<b>TD</b>	theater distribution
<b>TDA</b>	Table of Distribution and Allowance
<b>TDC</b>	theater distribution center
<b>TDT</b>	trial defense team
<b>TEU</b>	twenty-foot equivalent unit
<b>TFA</b>	toxic-free area
<b>TG R5</b>	theater gateway reception, replacement, rest and recuperation, return to duty, redeployment
<b>TIS-TO</b>	transportation information systems – theater operations
<b>TLF</b>	team logistics civil augmentation program - forward
<b>TMAO</b>	theater mortuary affairs officer
<b>TMEP</b>	theater mortuary evacuation point
<b>TMIP</b>	theater medical information program
<b>TMMC</b>	theater materiel management center
<b>TMR</b>	transportation movement release
<b>TO</b>	theater opening
<b>TOC</b>	tactical operations center
<b>TOE</b>	table of organization and equipment
<b>TPT</b>	tactical petroleum terminal
<b>TSA</b>	theater storage area

---

<b>TSC</b>	theater sustainment command
<b>TTB</b>	transportation terminal battalion/brigade
<b>TTOE</b>	transportation theater opening element
<b>TTP</b>	tactics, techniques, and procedures
<b>UAS</b>	unmanned aircraft system
<b>UCMJ</b>	Uniform Code of Military Justice
<b>UGR</b>	unitized group ration
<b>UGR-H&amp;S</b>	unitized group ration – heat and serve
<b>ULLS</b>	unit level logistics system
<b>ULLS-AE</b>	unit level logistics system – aviation enhanced
<b>ULLS-G</b>	unit level logistics system - ground
<b>UMT</b>	unit ministry team
<b>US</b>	United States
<b>USACASCOM</b>	United States Army Combined Arms Support Command
<b>USAF</b>	United States Air Force
<b>USAMC</b>	United States Army Materiel Command
<b>USAREUR</b>	United States Army, European Command
<b>USASOC</b>	United States Army Special Operations Command
<b>UMT</b>	unit ministry team
<b>USTRANSCOM</b>	United States Transportation Command
<b>VBIED</b>	vehicle-borne improvised explosive device
<b>VSAT</b>	very small aperture terminal
<b>WPOD</b>	water port of debarkation
<b>WPS</b>	Worldwide Port System

**This page intentionally left blank.**

## References

This reference lists field manuals by the new number followed by the old number in parenthesis.

### ARMY PUBLICATIONS

Most Army publications are available online at <http://www.train.army.mil>

AR 10-87. *Army Commands, Army Service Component Commands, and Direct Reporting Units*. 4 September 2007

AR 56-4. *Distribution of Materiel and Distribution Platform Management*. 2 March 2007

FM 1-0 (12-6). *Human Resources Support*. 21 February 2007

FM 1-02 (101-5-1). *Operational Terms and Graphics*. 21 September 2004

FM 1-06 (14-100). *Financial Management Operations*. 21 September 2006

FM 3-0. *Operations*. 27 February 2008

FM 3-04.500 (1-500). *Army Aviation Maintenance*. 23 August 2006

FM 3-05. *Army Special Operations Forces*. 20 September 2006

FM 3-05.140, *ARSOF Logistics*, Jul 06

FM 3-11. *Multiservice Tactics, Techniques, and Procedures for Nuclear, Biological, and Chemical Defense Operations*. 10 March 2003

FM 3-11.3. *Multiservice Tactics, Techniques, and Procedures for Chemical, Biological, Radiological, and Nuclear Contamination Avoidance*. 2 February 2006

FM 3-11.4. *Multiservice Tactics, Techniques, and Procedures for Nuclear, Biological, and Chemical (NBC) Protection*. 2 June 2003

FM 3-11.5. *Multiservice Tactics, Techniques, and Procedures for Chemical, Biological, Radiological, and Nuclear Decontamination*. 4 April 2006

FM 3-11.21. *Multiservice Tactics, Techniques, and Procedures for Chemical, Biological, Radiological, and Nuclear Consequence Management Operations*. 1 April 2008

FM 3-11.34. *Multiservice Tactics, Techniques, and Procedures for Installation CBRN Defense*. 6 November 2007

FM 3-06.11. *Combined Arms Operations in Urban Terrain*. 28 February 2002

FM 3-13 (100-6). *Multi-Service Tactics, Techniques, and Procedures for the Reprogramming of Electronic Warfare and Target Sensing Systems*. 22 January 2007

FM 3-19.1 (19-1). *Military Police Operations*. 22 March 2001

FM 3-19.4 (19-4). *Military Police Leader's Handbook*. 4 March 2002

FM 3-34 (5-100). *Engineer Operations*. 2 January 2004

FM 3-90. *Tactics*. 4 July 2001

FM 3-100.21. *Contractors on the Battlefield*. 3 January 2003

FM 4-0 (100-10). *Combat Service Support*. 29 August 2003

## References

---

- FM 4-01.4 (100-10-1) *Theater Distribution*, 1 Oct 1999
- FM 4-01.41. *Army Rail Operations*. 12 December 2003
- FM 4-01.45. *Multi-Service Tactics, Techniques, and Procedures for Tactical Convoy Operations*. 24 March 2005
- FM 4-02 (8-10). *Force Health Protection in a Global Environment*. 13 February 2003
- FM 4-02.42 (8-42) *Combat Health Support in Stability Operations and Support Operations*, 27 Oct 1997
- FM 4-20.21 (10-52) *Water Supply in Theaters of Operation*, 11 Jul 1990
- FM 4-20.23 (10-52-1) *Water Supply Point Equipment and Operations*, 18 Jun 1991
- FM 4-30.1 (9-6). *Munitions Distribution in the Theater of Operations*. 16 Dec 2003
- FM 4-30.3 (9-43-1). *Maintenance Operations and Procedures*. 28 July 2004
- FM 4-93.4. *Theater Support Command*. 15 April 2003
- FM 5-71-100. *Division Engineer Combat Operations*. 22 April 1993
- FM 6-0. *Mission Command: Command and Control of Army Forces*. 11 August 2003
- FM 7-15. *The Army Universal Task List*. 31 August 2003
- FM 7-98. *Operations in a Low-Intensity Conflict*. 19 October 1992
- FM 10-1. *Quartermaster Principles*. 11 August 1994
- FM 27-100. *Legal Support Operations*. 1 March 2000
- FM 34-130. *Intelligence Preparation of the Battlefield*. 8 July 1994
- FMI 1-0.01. *S-1 Operations*. 10 October 2007

## JOINT PUBLICATIONS

Most joint publications are available online at <http://www.dtic.mil/doctrine/>

- JP 1-06 *Joint Tactics, Techniques and Procedures for Financial Management During Joint Operations*, 22 Dec 1999
- JP 3-09 *Joint Doctrine for Fire Support*, 12 May 1998
- JP 3-10 *Joint Security Operations in Theater*, 28 May 1996
- JP 3-35 *Joint Deployment and Redeployment Operations*, 7 Sep 1999
- JP 4-0 *Doctrine for Logistics Support of Joint Operations*, 6 Apr 2000
- JP 4-01.3 *Joint Tactics, Techniques and Procedures for Movement Control*, 9 Apr 2002
- JP 4-01.4 *Joint Tactics, Techniques and Procedures for Joint Theater Distribution*, 22 Aug 2000
- JP 4-07 *JTTP for Common User Logistics during Joint Operations*, 11 Jun 2001
- JP 4-08 *Joint Doctrine for Logistics Support of Multinational Operations*. 25 Sep 2002
- Luck, Gary GEN (Ret) "Insights on Joint Operations: The Art and Science" Joint Warfighting Center USJFCOM, Sep 2006

# INDEX

aerial re-supply.....	2-6	CSSAMO .....	2-4, 2-18	PARC .....	2-5
airdrop.....	2-9, 4-31	CSSB.....	2-4, 2-18	PBUSE .....	3-5
All Source Analysis System ..	2-15, 3-2	Distribution operations .....	2-6	Property book .....	2-16
APODs.....	4-4, 4-28	Field services.....	4-22	protection.....	B-1
Authorized Stockage List	2-8, 2-19, 2-35	Financial Management .....	4-51	S-1.....	2-15
Base and base cluster..	B-1, B-3, B-8	Fire support .....	B-8	S-2.....	2-15
BCS3 .....	2-15, 2-17, 3-2, 3-3	Forward Support Company.	1-5	S-3.....	2-16
BCT.....	1-5, 1-8, 2-3	Host nation support.....	1-8	S-4.....	2-16
BSB.....	1-5, 2-3, 2-32	Human Resources .....	2-19	S-6.....	2-16
C2 .....	3-1	Intelligence.....	A-1	SAMS .....	3-6
Chaplain.....	2-27	In-transit visibility .....	3-12	SARSS .....	3-5
Civil affairs .....	2-20	level I threats .....	B-1	SJA.....	2-22
Communications .....	3-13	Level II threat.....	B-1	Special Troops Battalion.....	2-6
Contracting.....	1-11	level III threats .....	B-1	Strategic lift.....	A-1
Convoy Security.....	B-10	LOGCAP.....	1-10	Support Operations .....	2-16
CSM.....	2-21	MCS.....	3-2	tactical convoys .....	B-19
		METL.....	2-13	tactical level	1-2, 2-4, 2-13, 2-25
		NETOPS.....	2-16	Theater Sustainment	
		Non-contiguous.....	1-1	Command.....	2-32
		Operating environment .....	1-1	Total Asset Visibility.....	2-3, 3-6

**This page intentionally left blank.**



**FMI 4-93.2**  
**4 February 2009**

By order of the Secretary of the Army:

**GEORGE W. CASEY, JR.**  
*General, United States Army*  
*Chief of Staff*

Official:

A handwritten signature in black ink that reads "Joyce E. Morrow". The signature is written in a cursive style with a large initial "J" and "M".

**JOYCE E. MORROW**  
*Administrative Assistant to the*  
*Secretary of the Army*  
0901402

**DISTRIBUTION:**

*Active Army, Army National Guard, and U.S. Army Reserve:* Not to be distributed; electronic media only.

